



contacto



2022

Kochtopfserie 2100

Die **contacto** Kochtopfserie 2100 hat matt polierte Oberflächen und ist somit unempfindlicher gegen optische Verunreinigungen. Der Standard in der Profiküche.

2100 Cookware range

The **contacto** 2100 range of cookware has a satin polished finish and therefore looks good consistently even when well used. The standard in the professional kitchen.

Auf allen Kochstellen einsetzbar, bis \varnothing 50 cm auch für Induktion.

Ganz aus Edelstahl 18/10 gefertigt:
0,7 mm Materialstärke bei \varnothing 12-24 cm
1,0 mm Materialstärke bei \varnothing 28-40 cm
1,2 mm Materialstärke bei \varnothing 40-60 cm

Der bis zu 7 mm starke Boden ist in der bewährten Sandwich-Technik (Edelstahl-Alu-Edelstahl) gefertigt.

Suitable for any cooking method including induction up to \varnothing 50 cm.

*Manufactured from 18/10 stainless steel:
 \varnothing 12-24 cm => material thickness 0.7 mm
 \varnothing 28-40 cm => material thickness 1.0 mm
 \varnothing 40-60 cm => material thickness 1.2 mm*

All these pots and pans have an up to 7 mm heavy aluminium/stainless steel sandwich base.



- schwere Qualität
- matt gebürstet
- bis 7 mm Sandwichboden
- Kaltgriffe
- Schüttrand

- *heavy gauge*
- *satin polished finish*
- *up to 7 mm sandwich base*
- *cool grip handles*
- *pouring rim*

Kochtopf, hoch Deep Stock Pot



Art-Nr. Part No.		\varnothing innen \varnothing Inside cm	Höhe außen Outer Height cm	\varnothing Boden \varnothing Base cm
2101/160	3 l	16	16	14
2101/200	6 l	20	19,5	18
2101/220	7 l	22	20	20
2101/240	10 l	24	25	21,5
2101/280	17 l	28	28,5	25
2101/320	25 l	32	33	28,5
2101/360	36 l	36	36	32
2101/400	50 l	40	41	34,5
2101/450	70 l	45	46,5	40
2101/500	100 l	50	51	44
2101/600*	155 l	60	55	53

*Versand dieser Größe nur per Spedition möglich.

*For this size pallet delivery only.

Deckel bitte separat bestellen (Art. 2161)

Please order lids separately (Part No.2161). $\frac{3}{4}$ " swivel handle tap and stainless steel strainer available on request from the UK only.

Kochtopf, mittelhoch Medium Stock Pot



Art-Nr. Part No.		\varnothing innen \varnothing Inside cm	Höhe außen Outer Height cm	\varnothing Boden \varnothing Base cm
2104/240	9 l	24	21	21,5
2104/280	15 l	28	25	25
2104/320	22 l	32	28,5	28
2104/360	30 l	36	30	32,5
2104/400	40 l	40	33	34,5

Deckel bitte separat bestellen (Art. 2161)

Please order lids separately (Part No. 2161)



Art-Nr. Part No.	∅ innen ∅ Inside cm	Höhe außen Outer Height cm	∅ Boden ∅ Base cm
2107/160	2 l	16	11,5
2107/180	3 l	18	12
2107/200	4 l	20	12,5
2107/220	5 l	22	14
2107/240	6,5 l	24	16
2107/260	8 l	26	18
2107/280	10 l	28	19,5
2107/320	15 l	32	23
2107/360	22 l	36	25
2107/400	28 l	40	28,5
2107/450	44 l	45	32,5
2107/500	54 l	50	34,5
2107/600	100 l	60	40
			44,5
			53

Deckel bitte separat bestellen (Art. 2161)
Please order lids separately (Part No. 2161)



Kochtopf, niedrig
Deep Casserole

Art-Nr. Part No.	∅ innen ∅ Inside cm	Höhe außen Outer Height cm	∅ Boden ∅ Base cm
2109/140	1 l	14	7
2109/160	1,5 l	16	8
2109/180	2 l	18	8
2109/200	2,5 l	20	8,5
2109/220	3,5 l	22	9,5
2109/240	4,5 l	24	11
2109/260	5,5 l	26	11
2109/280	7 l	28	13
2109/320	12 l	32	16
2109/360	17 l	36	18
2109/400	24 l	40	19,5
2109/450	35 l	45	22,5
2109/500	38 l	50	23
2109/600	70 l	60	25
			28
			32
			34
			40,5
			45
			53

Deckel bitte separat bestellen (Art. 2161)
Please order lids separately (Part No. 2161)



Bratentopf
flache Form
Casserole/Braising Pan
shallow

Art-Nr. Part No.	∅ innen ∅ Inside cm	Höhe außen Outer Height cm	∅ Boden ∅ Base cm
2106/120	0,8 l	12	7
2106/140	1,2 l	14	8
2106/160	2 l	16	11,5
2106/180	3 l	18	12
2106/200	4 l	20	12,5
2106/240	6,5 l	24	13,5
2106/280*	10 l	28	15,5
			18
			21,5
			25

*mit zusätzlichem Gegengriff.
*with extra side handle.

Deckel bitte separat bestellen (Art. 2161)
Please order lids separately (Part No. 2161)



Stielkasserolle, hoch
mit Rohrgriff und Schüttrand
Deep Sauce Pan
deep, with hollow handle

Art-Nr. Part No.	∅ innen ∅ Inside cm	Höhe außen Outer Height cm	∅ Boden ∅ Base cm
2108/140	1 l	14	7
2108/160	1,5 l	16	8
2108/180	2 l	18	8,5
2108/200	2,5 l	20	9,5
2108/240	4,5 l	24	11
2108/280	7 l	28	13
			16
			18
			21
			25

Deckel bitte separat bestellen (Art. 2161)
Please order lids separately (Part No. 2161)



Stielkasserolle, niedrig
Sautoirform, mit Rohrgriff und Schüttrand
Shallow Sauté Pan
with hollow handle

Stielkasserolle

mit Rohrgriff und beidseitigem Ausguss

Sauce Pan

with hollow handle and two pouring lips



Art-Nr. Part No.	∅ innen ∅ Inside cm	Höhe außen Outer Height cm	∅ Boden ∅ Base cm
2116/160	1,5 l 16	8	14
2116/200	2,5 l 20	9,5	18

Deckel bitte separat bestellen (Art. 2161)
Please order lids separately (Part No.2161)

Bratpfanne

mit Rohrgriff und Schüttrand

Frying Pan

with hollow handle



Art-Nr. Part No.	∅ innen ∅ Inside cm	Höhe außen Outer Height cm	∅ Boden ∅ Base cm
2103/200	20	4,5	14
2103/240	24	5	18
2103/280	28	5,5	21,5
2103/320	32	6	25
mit zusätzlichem Gegengriff: / with extra side handle:			
2103/360	36	7	29
2103/400	40	7	31

Deckel bitte separat bestellen (Art. 2161).

Bitte beachten Sie die für die Induktionskochstelle angegebenen Mindestbodendurchmesser.

Please check the minimum base diameter required for your induction hob. Please order lids separately (Part No. 2161).

Induction hobs must be smaller than the diameter of the base.

Antihaft-Bratpfanne

mit PTFE-Beschichtung, mit Rohrgriff

Non-stick Frying Pan

with PTFE coating, with hollow handle



Art-Nr. Part No.	∅ innen ∅ Inside cm	Höhe außen Outer Height cm	∅ Boden ∅ Base cm
2013/200	20	4,5	14
2013/240	24	4,5	18
2013/280	28	5,5	21,5
2013/320	32	6	25
Mit zusätzlichem Gegengriff: / With extra side handle:			
2013/360	36	7	29
2013/400	40	7	31

Deckel bitte separat bestellen (Art. 2161).

Bitte beachten Sie die für die Induktionskochstelle angegebenen Mindestbodendurchmesser.

Beachten Sie auch die Pflegehinweise unter "PTFE": die Pfannen dürfen nicht über +230°C erhitzt werden.

Please order lids separately (Part No. 2161).

Please check the minimum base diameter required for your induction hob. Please ensure the non-stick surface is never heated above +230°C.

Art-Nr. Part No.	∅ innen ∅ Inside cm	Höhe außen Outer Height cm	∅ Boden ∅ Base cm
2102/200	20	4,5	14
2102/240	24	5	18
2102/280	28	5,5	21,5
2102/320	32	6	25
2102/360	36	7	29
2102/400	40	6,5	31
2102/460*	46	9	36
2102/600*	58	16	46
2102/800**	80	17	62

*ab ∅ 46 cm nicht induktionsgeeignet.

**Versand dieser Größe nur per Spedition möglich.

*not suitable for induction.

**For this size pallet delivery only.

Deckel bitte separat bestellen (Art. 2161)

Please order lids separately (Part No. 2161)



Bratpfanne / Paellapfanne

mit zwei seitlichen Kaltgriffen und Schüttrand

Frying / Paella Pan

with two side handles

Art-Nr. Part No.	passend zu Matches
2161/120	/120
2161/140	/140
2161/160	/160
2161/180	/180
2161/200	/200
2161/220	/220
2161/240	/240
2161/260	/260
2161/280	/280
2161/320	/320
2161/360	/360
2161/400	/400
2161/450	/450
2161/500	/500
2161/600	/600



Deckel zur Serie 2100

passend zur Serie 2100
(ausgenommen der Sauteuse 2105)

Lid

matches 2100 series pots and pans
(except sauteuse 2105)

Art-Nr. Part No.	∅ innen ∅ Inside cm	Höhe außen Outer Height cm	∅ Boden ∅ Base cm
2105/160	1 l	16	11,5
2105/180	1,2 l	18	13
2105/200	1,5 l	20	14
2105/220	2 l	22	15
2105/240	2,8 l	24	18

Für Induktionskochstellen empfehlen wir unsere Serie Multiply auf Seite 11. Keine Deckel zu den Sauteusen lieferbar.

We recommend the Multiply sauteuse 548 on page 11 for induction.

No lids available for these sauteuses.



Sauteuse

mit Rohrgriff, gerade auslaufender Rand

Sauteuse

with hollow handle with straight rim

Art-Nr. Part No.	∅ innen ∅ Inside cm	Höhe Depth cm
6004/140	1,8 l	14
6004/160	2,5 l	16

Deckel hierzu bitte separat bestellen: / Please order lids separately:

2061/140 14

2061/160 16



Milchtopf

hochglänzend, mit Schüttrand und Griff

Milk Pot

mirror polished finish, with handle and pouring edge

Kochtopfserie 2200

Die **contacto** Kochtopfserie 2200 erfüllt alle Anforderungen, die an Qualitätstöpfe gestellt werden und ist überall einsetzbar.

2200 Cookware range

The **contacto** 2200 range of cookware meets every requirement expected of it in terms of quality and it can be used on any type of hob.

Der solide Aluminium-Sandwichboden ist hygienisch verkapselt. Bis \varnothing 32 cm sind die Töpfe mit einem hochglänzenden Rand versehen. Auf allen Kochstellen einsetzbar.

Ganz aus rostfreiem Edelstahl gefertigt:
 0,8 mm Materialstärke bei \varnothing 16-28 cm
 1,0 mm Materialstärke bei \varnothing 32-40 cm
 1,2 mm Materialstärke bei \varnothing 45-50 cm

The aluminium/stainless steel sandwich base is encapsulated with stainless steel. Satin polished with a mirrored rim up to size \varnothing 32 cm.

Suitable for any cooking method including induction.

Manufactured from stainless steel:

\varnothing 16-28 cm => material thickness 0.8 mm

\varnothing 32-40 cm => material thickness 1.0 mm

\varnothing 45-50 cm => material thickness 1.2 mm



- schwere Qualität
- seidmatt/hochglänzend
- verkapselter Sandwichboden
- Kaltgriffe
- Schüttrand

- heavy gauge
- satin/mirror polished
- encapsulated base
- cool grip handles
- pouring rim

Kochtopf, hoch

Deep Stock Pot



Art-Nr. Part No.	\varnothing innen \varnothing Inside cm	Höhe außen Outer Height cm	\varnothing Boden \varnothing Base cm
2201/160	3 l 16	16	15
2201/200	6 l 20	20	19
2201/240	10 l 24	25	23
2201/280	16 l 28	27	27
2201/320	25 l 32	33	31
2201/360	36 l 36	37	35
2201/400	50 l 40	41	39
2201/450	70 l 45	46	44
2201/500	100 l 50	51	49

Deckel bitte separat bestellen (Art. 2261)

Please order lids separately (Part No. 2261). $\frac{3}{4}$ " swivel handle tap and stainless steel strainer available on request from the UK only.

Kochtopf, mittelhoch

Medium Stock Pot



Art-Nr. Part No.	\varnothing innen \varnothing Inside cm	Höhe außen Outer Height cm	\varnothing Boden \varnothing Base cm
2204/240	9 l 24	21	23
2204/260	12 l 26	24	25
2204/300	18 l 30	26	29
2204/320	20 l 32	27	31
2204/340	24 l 34	28	33

Deckel bitte separat bestellen (Art. 2261)

Please order lids separately (Part No. 2261)

Art-Nr. Part No.	∅ innen ∅ Inside cm	Höhe außen Outer Height cm	∅ Boden ∅ Base cm
2207/160	2,5 l	16	13
2207/200	4 l	20	15
2207/240	7 l	24	17
2207/280	10 l	28	19
2207/320	15 l	32	21
2207/360	22 l	36	23
2207/400	28 l	40	26
2207/450	44 l	45	29
2207/500	60 l	50	33

Deckel bitte separat bestellen (Art. 2261)
Please order lids separately (Part No. 2261)



Kochtopf, niedrig
Deep Casserole

Art-Nr. Part No.	∅ innen ∅ Inside cm	Höhe außen Outer Height cm	∅ Boden ∅ Base cm
2209/160	1,5 l	16	8
2209/200	3,5 l	20	11
2209/240	5 l	24	12
2209/280	8 l	28	14
2209/320	12 l	32	17
2209/360	10 l	36	12
2209/400	15 l	40	14
2209/450	20 l	45	15
2209/500	38 l	50	20,5

Deckel bitte separat bestellen (Art. 2261)
Please order lids separately (Series 2261)



Bratentopf
flache Form
Casserole/Braising Pan
shallow

Art-Nr. Part No.	∅ innen ∅ Inside cm	Höhe außen Outer Height cm	∅ Boden ∅ Base cm
2206/160	2,5 l	16	13
2206/180	3,25 l	18	13
2206/200	4 l	20	15
2206/240	7 l	24	17

Deckel bitte separat bestellen (Art. 2261)
Please order lids separately (Part No. 2261)



Stielkasserolle, hoch
mit Rohrgriff
Deep Sauce Pan
with hollow handle

Art-Nr. Part No.	∅ innen ∅ Inside cm	Höhe außen Outer Height cm	∅ Boden ∅ Base cm
2208/160	1,5 l	16	10
2208/180	2,5 l	18	10
2208/200	3 l	20	11
2208/240	5 l	24	12

Deckel bitte separat bestellen (Art. 2261)
Please order lids separately (Series 2261)



Stielkasserolle, niedrig
Sautoirform, mit Rohrgriff
Shallow Sauté Pan
with hollow handle

Art-Nr. Part No.	∅ innen ∅ Inside cm	Höhe außen Outer Height cm	∅ Boden ∅ Base cm
---------------------	---------------------------	----------------------------------	-------------------------

niedrige Ausführung, hochglänzend:
shallow version, mirror polished:

6602/160	4,5 l	16	23,5	14,5
----------	-------	----	------	------

hohe Ausführung, seidenmatt gebürstet mit hochglänzendem Rand: /
deep version, satin polished with mirror polished rim:

2202/160	5,5 l	16	29,5	14
----------	-------	----	------	----



Spargelkochtopf
ganz aus Edelstahl 18/10, komplett mit Einsatz und
Deckel, induktionsgeeignet, schwere Qualität

Asparagus Pot
stainless steel 18/10, with lid and insert of stainless
steel, suitable for any cooking method including
induction, heavy gauge



Bratpfanne

mit Rohrgriff

Frying Pan

with hollow handle



Art-Nr. Part No.	∅ innen ∅ Inside cm	Höhe außen Outer Height cm	∅ Boden ∅ Base cm
2203/200	20	5	14
2203/240	24	5	18
2203/280	28	6	22
2203/320	32	6	26
Mit zusätzlichem Gegengriff: / With extra side handle:			
2203/360	36	7,5	28
2203/400	40	8	31

Deckel bitte separat bestellen (Art. 2261).

Bitte beachten Sie die für die Induktionskochstelle angegebenen Mindestbodendurchmesser.

Please order lids separately (Part No. 2261).

Please check the minimum base diameter required for your induction hob.

Antihaft-Bratpfanne

Non-stick Frying Pan



Art-Nr. Part No.	∅ innen ∅ Inside cm	Höhe außen Outer Height cm	∅ Boden ∅ Base cm
2213/200	20	5	14
2213/240	24	5	18
2213/280	28	6	22
2213/320	32	6	26
mit zusätzlichem Gegengriff: / with extra side handle:			
2213/360	36	7,5	28

Deckel bitte separat bestellen (Art. 2261).

Bitte beachten Sie die für die Induktionskochstelle angegebenen Mindestbodendurchmesser.

Beachten Sie auch die Pflegehinweise unter "PTFE": die Pfannen dürfen nicht über 230°C erhitzt werden

Please order lids separately (Part No. 2261).

Please check the minimum base diameter required for your induction hob. Please ensure the non-stick surface is never heated above 230°C.

Deckel zur Serie 2200

passend zur Serie 2200
(ausgenommen der Sauteuse 2205)

Lid

matches 2200 series pots and pans,
(except sauteuse 2205)



Art-Nr. Part No.	passend zu Matches
2261/160	/160
2261/180	/180
2261/200	/200
2261/240	/240
2261/260	/260
2261/280	/280
2261/300	/300
2261/320	/320
2261/340	/340
2261/360	/360
2261/400	/400
2261/450	/450
2261/500	/500

Sauteuse

aus Edelstahl 18/10, matt poliert, mit Rohrgriff,
mit Schüttrand, induktionsgeeignet

Sauteuse

18/10 stainless steel, matt polished, with hollow handle,
wide pouring rim, suitable for any cooking method
including induction



Art-Nr. Part No.	∅ innen ∅ Inside cm	Höhe außen Outer Height cm	∅ Boden ∅ Base cm
2212/160	1 l	16	6,5
2212/200	1,6 l	20	7
2212/240	2,7 l	24	8,5

Keine Deckel zu den Sauteusen lieferbar. Für Induktionskochstellen empfehlen wir unsere Serie Multiply auf Seite 11.

No lids available for these sauteuses. We recommend the Multiply sauteuse 548 on page 11 for induction.



Kochtopfserie 2000

Die hochglänzend polierte **contacto** Kochtopfserie 2000 ist in funktionaler und optischer Hinsicht ein Spitzenprodukt. Jahrzehntelange Erfahrung spiegeln sich hier wider.

2000 Cookware range

The **contacto** mirror polished 2000 range of cookware is fantastic in both functionality and appearance. A reflection of decades of experience.



- extra schwere Qualität
- hochglänzend poliert
- bis 7 mm Sandwichboden
- Kaltgriffe
- Schüttrand
- *extra heavy gauge*
- *mirror polished*
- *up to 7 mm sandwich base*
- *cool grip handles*
- *pouring rim*

Auf allen Kochstellen einsetzbar, alle Größen auch für Induktionsflächen.

Ganz aus Edelstahl 18/10 gefertigt:
1,0 mm Materialstärke bei \varnothing 12-28 cm
1,2 mm Materialstärke bei \varnothing 32-50 cm

Die Töpfe und Pfannen sind mit einem soliden bis zu 7 mm starken Edelstahl-Aluminium-Edelstahl-Boden in der Sandwich-Technik versehen.

Suitable for any cooking method including induction in all sizes.

*Manufactured from 18/10 stainless steel:
Material thickness sizes \varnothing 12-28 cm = 1.0 mm
Material thickness sizes \varnothing 32-50 cm = 1.2 mm*

All these pots and pans have a heavy up to 7 mm aluminium/stainless steel sandwich base.

Art-Nr. Part No.	\varnothing innen \varnothing Inside cm	Höhe außen Outer Height cm	\varnothing Boden \varnothing Base cm	
2001/160	3 l	16	16	14
2001/200	6 l	20	19,5	18
2001/220	7 l	22	20	20
2001/240	10 l	24	25	21,5
2001/280	17 l	28	28,5	25
2001/320	25 l	32	33	28,5
2001/360	36 l	36	36	32
2001/400	50 l	40	41	34,5
2001/450	70 l	45	46,5	40
2001/500	100 l	50	51	44

Deckel bitte separat bestellen (Art. 2061)
Please order lids separately (Part No.2061). $\frac{3}{4}$ " swivel handle tap and stainless steel strainer available on request from the UK only.



Kochtopf, hoch
Deep Stock Pot

Art-Nr. Part No.	\varnothing innen \varnothing Inside cm	Höhe außen Outer Height cm	\varnothing Boden \varnothing Base cm	
2004/240	9 l	24	21	21,5
2004/280	15 l	28	25	25
2004/320	22 l	32	28,5	28
2004/360	29 l	36	30	32,5
2004/400	40 l	40	33	34,5

Deckel bitte separat bestellen (Art. 2061)
Please order lids separately (Part No.2061)



Kochtopf, mittelhoch
Medium Stock Pot

Kochtopf, niedrig

Deep Casserole



Art-Nr. Part No.		∅ innen ∅ Inside cm	Höhe außen Outer Height cm	∅ Boden ∅ Base cm
2007/160	2 l	16	11,5	14
2007/180	3 l	18	12,5	16
2007/200	4 l	20	13,5	18
2007/220	5,5 l	22	15	20
2007/240	6,5 l	24	16	21,5
2007/260	8 l	26	16	23
2007/280	10 l	28	17,5	25
2007/320	15 l	32	19,5	28,5
2007/360	22 l	36	23	32,5
2007/400	28 l	40	26	34,5
2007/450	44 l	45	29	40
2007/500	54 l	50	31	44,5

Deckel bitte separat bestellen (Art. 2061)
Please order lids separately (Part No.2061)

Bratentopf

flache Form

Casserole/Braising Pan

shallow



Art-Nr. Part No.		∅ innen ∅ Inside cm	Höhe außen Outer Height cm	∅ Boden ∅ Base cm
2009/160	1,5 l	16	8	14
2009/180	2 l	18	8,5	16
2009/200	2,5 l	20	9,5	18
2009/220	3,5 l	22	10	20
2009/240	4,5 l	24	12	21,5
2009/260	5,5 l	26	12	23,5
2009/280	7 l	28	13	25
2009/320	12 l	32	16	28
2009/360	17 l	36	18	32
2009/400	24 l	40	19,5	34
2009/450	35 l	45	22,5	40,5
2009/500	38 l	50	20,5	45

Deckel bitte separat bestellen (Art. 2061)
Please order lids separately (Part No.2061)

Stielkasserolle, hoch

mit Schüttrand, mit Rohrgriff

Sauce Pan, deep

with pouring rim, with hollow handle



Art-Nr. Part No.		∅ innen ∅ Inside cm	Höhe außen Outer Height cm	∅ Boden ∅ Base cm
2006/120	0,8 l	12	7	10
2006/140	1,2 l	14	8	12
2006/160	2 l	16	11,5	14
2006/180	3 l	18	12,5	16
2006/200	4 l	20	13,5	18
2006/240	6,5 l	24	15,5	21,5
2006/280*	10 l	28	18	25

*mit zusätzlichem Gegengriff
*with extra side handle

Deckel bitte separat bestellen (Art. 2061)
Please order lids separately (Part No.2061)

Stielkasserolle, mittelhoch

mit Schüttrand, mit Rohrgriff

Sauté Pan, medium

with pouring rim, with hollow handle



Art-Nr. Part No.		∅ innen ∅ Inside cm	Höhe außen Outer Height cm	∅ Boden ∅ Base cm
2008/160	1,5 l	16	8	14
2008/180	2 l	18	8,5	16
2008/200	2,5 l	20	9,5	18
2008/240	4,5 l	24	11	21
2008/280	7 l	28	13	25

Deckel bitte separat bestellen (Art. 2061)
Please order lids separately (Part No.2061)

Stielkasserolle, extra niedrig

mit Schüttrand, mit Rohrgriff

Sauté Pan, shallow

with hollow handles and pouring rim, suitable for dishes such as rice and paella



Art-Nr. Part No.		∅ innen ∅ Inside cm	Höhe außen Outer Height cm	∅ Boden ∅ Base cm
2010/160	1,2 l	16	6	14
2010/180	1,6 l	18	6,5	16
2010/200	2,4 l	20	7,5	18
2010/240	4 l	24	9	21
2010/280	6,9 l	28	11	25

Deckel bitte separat bestellen (Art. 2061)
Please order lids separately (Part No.2061)



Art-Nr. Part No.	∅ innen ∅ Inside cm	Höhe außen Outer Height cm	∅ Boden ∅ Base cm
2003/200	20	4,5	14
2003/240	24	5	18
2003/260	26	5,6	20
2003/280	28	5,5	21,5
2003/320	32	6	25
Mit zusätzlichem Gegengriff: / With extra side handle:			
2003/360	36	7	29
2003/400	40	7	31

Deckel bitte separat bestellen (Art. 2061). Bitte beachten Sie die für die Induktionskochstelle angegebenen Mindestbodendurchmesser.
Please order lids separately (Part No.2061). Please check the minimum base diameter required for your induction hob.



Bratpfanne

mit Rohrgriff und Schüttrand

Frying Pan

with hollow handle and pouring rim

Art-Nr. Part No.	passend zu Matches
2061/120	/120
2061/140	/140
2061/160	/160
2061/180	/180
2061/200	/200
2061/220	/220
2061/240	/240
2061/260	/260
2061/280	/280
2061/320	/320
2061/360	/360
2061/400	/400
2061/450	/450
2061/500	/500



Deckel zur Serie 2000

passend zur Serie 2000
(ausgenommen der Sauteuse 2005)

Lid

matches 2000 series pots and pans
(except sauteuse 2005)

Art-Nr. Part No.	∅ innen ∅ Inside cm	Höhe außen Outer Height cm	∅ Boden ∅ Base cm	
2005/160	1 l	16	6	11,5
2005/180	1,2 l	18	6,5	13
2005/200	1,5 l	20	7	14
2005/220	2 l	22	7,5	15
2005/240	2,8 l	24	7,5	18

Keine Deckel zu den Sauteusen lieferbar.
No lids available for these sauteuses.



Sauteuse

mit gerade auslaufendem Rand, mit Rohrgriff

Sauteuse

with straight rim, with hollow handle

Art-Nr. Part No.	∅ innen ∅ Inside cm	Höhe außen Outer Height cm	∅ Boden ∅ Base cm	
2205/160	0,75 l	16	6	11
2205/180	1 l	18	6	11,5
2205/200	1,5 l	20	7	13
2205/240	2,25 l	24	8	15

Keine Deckel zu den Sauteusen lieferbar.
No lids available for these sauteuses.



Sauteuse

mit breitem Schüttrand, mit Rohrgriff

Sauteuse

wide pouring rim, with hollow handle

Art-Nr. Part No.	∅ innen ∅ Inside cm	Höhe außen Outer Height cm	∅ Boden ∅ Base cm	
548/160	1 l	16	6	11
548/180	1,5 l	18	6	13,5
548/200	2 l	20	7	14
548/220	2,5 l	22	7	16
548/240	3 l	24	8	18

Keine Deckel zu den Sauteusen lieferbar.
No lids available for these sauteuses.



Sauteuse Multiply

mit geradem Rand, aus mehrschichtigem Material: Ummantelung aus Edelstahl 18/10 und 18/0, Kern aus Aluminium, hochglänzend poliert, induktionsgeeignet, mit Rohrgriff, schwere Qualität

Sauteuse

multi layered material incl. aluminium, sandwiched between two layers of 18/10 and 18/0 stainless steel, suitable for induction, mirror polished, with hollow handle and straight rim heavy gauge



Spezialtöpfe & Einsätze

Die verschiedenen Dampf- und Kocheinsätze ermöglichen ein nährstoff- und aromaschonendes Garen und Dämpfen der Lebensmittel.

Specialist Cookware & Inserts

The different steam and cooking inserts enable healthy nutritional food to be produced.

Schnellkochtopf

aus Edelstahl 18/10, hochglänzend, mit Sandwichboden, induktionsgeeignet, mit Drahteinsatz, schwere Qualität

Pressure Cooker

18/10 stainless steel, mirror polished finish, with sandwich base, suitable for induction, with wire basket, heavy gauge



Art-Nr. Part No.	∅ innen ∅ Inside cm	Höhe innen Inner Height cm	∅ Boden ∅ Base cm
---------------------	---------------------------	----------------------------------	-------------------------

PRODUKTION
EINGESTELLT
PRODUCTION
DISCONTINUED

Kartoffelkochkessel

aus Edelstahl 18/10, hochglänzend poliert, Sandwichboden, komplett mit Deckel und Standard-Hahn 1/2", induktionsgeeignet, schwere Qualität

Stock/Boiling Pot with Tap

18/10 stainless steel, mirror polished finish, sandwich base, with lid and swivel tap 1/2", suitable for any cooking method including induction, heavy gauge



Art-Nr. Part No.	∅ innen ∅ Inside cm	Höhe außen Outer Height cm	∅ Boden ∅ Base cm	
2112/320	25 l	32	33	28,5
2112/360	36 l	36	36	32
2112/400	50 l	40	40	34,5
2112/450	70 l	45	45	40

3008/995 No-Drip-Hahn (optional): /
Non-Drip Tap:

Einsatz zum Kartoffelkocher

aus Edelstahl 18/10, für Töpfe 2001, 2101, 2112, 2201, mit 9 mm-Lochung, Bodenabstand 5 cm, schwere Qualität

Trivet/Drainer plate

18/10 stainless steel, for pots 2001, 2101, 2112 and 2201, 9 mm perforations, base clearance 5 cm



Art-Nr. Part No.	∅ dia.	Höhe gesamt Overall Height
Für Töpfe mit ∅ 32 cm: / For ∅ 32 cm pots:		
2113/320	31,5 cm	28 cm
Für Töpfe mit ∅ 36 cm: / For ∅ 36 cm pots:		
2113/360	35,5 cm	30 cm
Für Töpfe mit ∅ 40 cm: / For ∅ 40 cm pots:		
2113/400	39,5 cm	35 cm
Für Töpfe mit ∅ 45 cm: / For ∅ 45 cm pots:		
2113/450	44,5 cm	40 cm

Weitere Größen auf Anfrage.
Further sizes on request.



Art-Nr. Part No.	∅ innen ∅ Inside cm	Höhe außen Outer Height cm	∅ Boden ∅ Base cm
2017/003	3 l	18	14
2017/006	6 l	24	18

2017/901 Ersatzmessstab / Spare Dip-Stick



Simmertopf

aus Edelstahl 18/10, hochglänzend, mit Kompensboden, induktionsgeeignet, mit Deckel, Messstab und Einfülltrichter, zum Zubereiten von Saucen und Milchspeisen ohne Anhaften und Überkochen der Speisen

Sauce Warmer/ Bain Marie Pot

18/10 stainless steel, mirror polished finish, with lid, dip-stick and funnel, suitable for any cooking method including induction, this design helps to avoid sauces etc. sticking to the pot



Art-Nr. Part No.	∅ innen ∅ Inside cm	Höhe außen Outer Height cm	∅ Boden ∅ Base cm
2129/240	5 l	24	21,5
2129/280	9 l	28	25
2129/320	15 l	32	28,5

Angegeben ist das Nutzvolumen des Einsatzes. Die Töpfe sind auch ohne Einsatz oder Deckel erhältlich.

The capacity indicated refers to the working capacity of the insert. Available without insert or lid on request.



Simmertopf, groß

aus Edelstahl 18/10, matt poliert, mit Sandwichboden und Ausgusschnaupe, induktionsgeeignet, komplett mit Einsatz 1405 und Deckel 2161

Double Boiler

18/10 stainless steel, suitable for induction, matt polished finish, complete with 1405 insert and lid 2161



Art-Nr. Part No.	∅ dia. cm	Höhe innen Inner Height cm
1405/240	5 l	24
1405/280	9 l	28
1405/320	15 l	32

Passend in Kochtöpfe 2001, 2101, 2201.

For 2001, 2101, 2201 stock pots.



Wasserbadeinsatz

aus Edelstahl 18/10, geschlossene Ausführung, mit verstärkten Kaltgriffen, schwere Qualität

Double boiler / Bain marie Insert

18/10 stainless steel, unperforated version, with reinforced handles



Art-Nr. Part No.	∅ außen ∅ Outside cm	Höhe Height cm
6101/360	33 l	36
6101/400	45 l	40
6101/450	65 l	45
6101/500	85 l	50

Deckel bitte separat bestellen (Art. 6161).

Weitere Größen auf Anfrage.

Please order lids separately (Part No.6161)

100 L stock pot with 3/4" swivel tap available on request from the UK only.



Kochtopf, Aluminium

hohe Form, aus 5,0 mm starkem Aluminium, Einschichtboden, mit Rohrgriffen aus Edelstahl 18/10. Für Gas- und konventionelle Elektrokokstellen geeignet.

Bitte beachten Sie unsere Pflegehinweise.

Aluminium Stock Pot

deep, 5.0 mm aluminium, 18/10 stainless steel handles. Suitable for gas and conventional electric cooking methods. Please read our instructions sheet carefully.



Art-Nr. Part No.	passend zu Matches
6161/360	/360
6161/400	/400
6161/450	/450
6161/500	/500



Deckel

aus Aluminium, passend zur Serie 6100

Lid

matches 6100 series pots and pans



Wasserkessel

aus Edelstahl 18/0, hochglänzend, mit Deckel, mit Flöte, mit schwarzem Duroplastgriff, einfacher Boden, induktionsgeeignet

Kettle with Whistle

18/0 stainless steel, mirror polished finish, suitable for induction, with black Duroplast handle and lid



Art-Nr. Part No.		∅ Boden ∅ Base cm	Höhe gesamt Overall Height cm
432/250	2,5 l	18,5	23
Mit beweglichem geschlossenen Griff: / With folding handle:			
432/450	4,5 l	22,5	25

Viertel-Einsatz für Teigwaren

aus Edelstahl 18/0, hochglänzend, mit abgerundeten Kanten, 3,5 mm-Lochung in der Wand und im Boden, mit Haken zum Einhängen am Topfrand

1/4 Pasta/Steamer Basket

18/0 stainless steel, mirror polished finish, 3.5 mm perforations in wall and base



Art-Nr. Part No.	∅ max. cm	Höhe gesamt Overall Height cm	Stiellänge Handle Length cm
Für Topf 2007/360, 2107/360 bzw. 2207/360: For 2007/360, 2107/360 and 2207/360 pots:			
1406/360	36	23	17
Für Topf 2007/400, 2107/400 bzw. 2207/400: For 2007/400, 2107/400 and 2207/400 pots:			
1406/400	40	26	17

Passende Töpfe finden Sie auf Seite 10, 3 und 7.
See pages 10, 3 and 7 for 2007, 2107 and 2207 pots.

Pasta-Einsatz

aus Edelstahl 18/0, mit verstärkten Kaltgriffen, mit 3 mm Boden- und 5 mm Seitenlochung, schwere Qualität

Pasta Basket

18/0 stainless steel, with reinforced handles, with 3 mm perforations in base, 5 mm perforations on side



Art-Nr. Part No.		∅ innen ∅ Inside cm	Höhe gesamt Overall Height cm
1401/200	4,5 l	20	14,5
1401/240	8,5 l	24	19
1401/280	13,5 l	28	22,5

Passend in Kochtöpfe 2001, 2101, 2201 und 2007, 2107, 2207.
For 2001, 2101, 2201 stockpots and 2007, 2107, 2207 deep casseroles.

Dampfagar-Einsatz

aus Edelstahl 18/0, matt gebürstet mit hochglänzendem Rand, mit verstärkten Kaltgriffen, mit 3 mm Bodenlochung, schwere Qualität

Steamer Insert

18/0 stainless steel, matt polished with mirror polished rim, with reinforced handles, with 3 mm perforations in base



Art-Nr. Part No.		∅ innen ∅ Inside cm	Höhe gesamt Overall Height cm
1403/200	2,5 l	20	9
1403/240	5 l	24	12
1403/280	7 l	28	12
1403/320	12 l	32	15
1403/360	16 l	36	17

Passend in Fleischtöpfe 2007, 2107, 2207.
For 2007, 2107, 2207 deep casseroles.

Gemüsedämpf-Einsatz

aus Edelstahl 18/0, mit ∅ 3 mm Lochung, Bodenabstand 2 cm

Steamer Basket

18/0 stainless steel, 3 mm perforations, base clearance 2 cm



Art-Nr. Part No.	∅ min. cm	∅ max. cm
1408/140	14	23
1408/200	18	27

Dampfkörbe und Gewürzkugeln

Steamer and Infuser



Art-Nr.	∅	Höhe gesamt	Höhe innen
Part No.	dia.	Overall Height	Inner Height
4852/150	15 cm	8 cm	4,5 cm
4852/175	17,5 cm	9 cm	5 cm
4852/200	20 cm	9 cm	5 cm



Dampfgarkorb

aus Bambus, zum Dämpfen von Dim Sum Gerichten

Bamboo Steamer

for Asian food



Art-Nr.	∅	Höhe gesamt	Höhe innen
Part No.	dia.	Overall Height	Inner Height
4854/200	20 cm	15 cm	2x 5 cm



Dampfgarkorb, doppelt

aus Bambus, zum Dämpfen von Dim Sum Gerichten

Bamboo Steamer

two tier



Art-Nr.	∅
Part No.	dia.
3300/055	5 cm
3300/075	7,5 cm



Gewürz-/Teesiebkuigel

ganz aus Edelstahl 18/10, extra feines Filtergewebe, mit 15 cm langer Kette

Tea Infuser

18/10 stainless steel, extra fine mesh, with 15 cm chain



Art-Nr.	∅
Part No.	dia.
3300/100	10 cm



Gewürz-/Teesiebkuigel

ganz aus Edelstahl 18/10, mittelfeines Gewebe, mit 15 cm langer Kette

Tea Infuser

18/10 stainless steel, medium mesh, with 15 cm chain



Art-Nr.	∅
Part No.	dia.
3300/150	15 cm



Gewürz-/Teesiebkuigel

aus Edelstahl 18/10, hochglänzend poliert, mit 20 cm langer Kette

Tea Infuser

18/10 stainless steel, mirror polished finish, with 20 cm chain



Art-Nr.	∅
Part No.	dia.
3307/150	15 cm



Gewürz-/Teekugel

aus Edelstahl 18/10, formstabiles Filterfeingewebe, mit 35 cm langer Kette

Tea Infuser

18/10 stainless steel, fine mesh, with 35 cm chain



Fischkochkessel

aus Edelstahl 18/0, seidenmatt poliert, mit gelochtem Siebeinsatz (10 mm-Lochung) und Deckel

Fish Kettle

18/0 stainless steel, satin polished finish, with handles each end, with trivet/drainier plate (10 mm perforations) and lid



Art-Nr. Part No.	Länge innen Inner Length cm	Breite innen Inner Width cm	Höhe Depth cm
Außenmaß: 50,5x15,5xH11,5 cm / Outer size: 50.5x15.5xH11.5 cm			
1177/050	44	13,5	10,5 6 l

Ohne Kompensboden, daher nur für die Brat- oder Backröhre geeignet!
Only suitable for oven use!

Bratpfanne, rechteckig

aus Aluminium, mit zwei Fallgriffen

Roasting Pan

aluminium, with handles each end



Art-Nr. Part No.	Länge außen Outer Length cm	Breite außen Outer Width cm	Höhe Depth cm
6941/450	48	32	8,5 10 l
6941/500	53	34,5	8,5 13 l
6941/600	63,5	42	9 20 l
6941/650	68	45,5	9,5 26 l

Längenangaben einschließlich Griffe.
Length includes handles.

Bratpfanne, rechteckig

aus Aluminium, innen mit PTFE-Antihafbeschichtung, mit zwei Fallgriffen

Non-Stick Roasting Pan

aluminium, PTFE non-stick coating inside, with handles each end



Art-Nr. Part No.	Länge außen Outer Length cm	Breite außen Outer Width cm	Höhe Depth cm
6947/450	48	32	8 10 l
6947/500	53	34,5	8,5 12 l
6947/600	63,5	42	9,5 20 l

Längenangaben einschließlich Griffe.
Length includes handles.

Deckel

zu Serien 6941 und 6947 aus Aluminium

Lid

for 6941 and 6947, aluminium



Art-Nr. Part No.	passend zu Matches
6948/450	/450
6948/500	/500
6948/600	/600

Bratpfanne, rechteckig

aus 1,5 mm starkem Edelstahl 18/10, seidenmatt poliert, schwere Qualität, mit Fallgriffen. Ohne Kompensboden, daher nur für den Backofen geeignet!

Roasting Pan

1.5 mm thick 18/10 stainless steel, satin polished finish, heavy gauge, with handles each end. Only suitable for oven use!



Art-Nr. Part No.	Länge Length cm	Breite außen Outer Width cm	Höhe außen Outer Height cm
141/350	37,5	27,5	7,5 6 l
141/400	42	28,5	9 9 l
141/450	47	32,5	9 10 l
141/500	52,5	32,5	9 12 l
141/640	62,5	37,5	9 24 l
141/650	63,5	45,5	9 35 l

Längenangaben ohne Griffe.
Length excludes handles.

Deckel

zu Bratpfanne 141

Lid

for roasting pan 141



Art-Nr. Part No.	passend zu Matches
143/400	141/400
143/450	141/450
143/500	141/500

mit zwei Griffen: / with 2 handles:

143/640	141/640
143/650	141/650

Bratpfanne GN 1/1

mit Fallgriffen an den kurzen Seiten, aus Edelstahl 18/10, matt poliert, mit Sandwichboden, induktionsgeeignet

Roasting Pan GN 1/1

with handles each end, 18/10 stainless steel, matt polished finish, with aluminium sandwich base, suitable for induction



Art-Nr. Part No.	Länge außen Outer Length cm	Breite außen Outer Width cm	Tiefe Depth mm
7500/532	53	32,5	100 15 l
7500/533	53	32,5	150 20 l

7511/530 Deckel GN 1/1 / Lid GN 1/1

8111/530 Gelochter Einsatz GN 1/1 / Perforated Insert GN 1/1

Deckel und Einsatz bitte separat bestellen.
Please order drainer and lid separately.



Art-Nr. Part No.	∅ innen ∅ Inside cm	Höhe Height cm	Stiellänge Handle Length cm
mit rundem Boden: / with round base:			
524/360	36	12,5	28



Wok

mit rundem Boden, aus mehrschichtigem Material: Ummantelung aus Edelstahl 18/10 und 18/0, Kern aus Aluminium, außen hochglänzend poliert, innen matt gebürstet, induktionsgeeignet

Wok

with round base, multi layered material incl. aluminium, sandwiched between layers of 18/10 and 18/0 stainless steel, suitable for induction, mirror polished outside, matt inside, heavy gauge

Art-Nr. Part No.	∅ innen ∅ Inside cm	Höhe Height cm	Stiellänge Handle Length cm
528/360	36	9	28

Antihaft-Beschichtung nicht über 230°C überhitzen.
Please ensure the non-stick surface is never heated above 230°C.



Antihaft-Wok

mit rundem Boden, aus mehrschichtigem Material, Ummantelung aus Edelstahl 18/10 und 18/0, Kern aus Aluminium, mit PTFE-Antihftbeschichtung, außen hochglänzend poliert, innen matt gebürstet, induktionsgeeignet

Non-stick Wok

with round base, multi layered material incl. aluminium, sandwiched between layers of 18/10 and 18/0 stainless steel, with PTFE non-stick coating, suitable for induction, mirror polished outside, matt inside

Art-Nr. Part No.	∅ innen ∅ Inside cm	Höhe Height cm	∅ Boden ∅ Base cm	Stiellänge Handle Length cm
526/360	36	9	14	28



Wok

mit abgeflachtem Boden, aus mehrschichtigem Material, Ummantelung aus Edelstahl 18/10 und 18/0, Kern aus Aluminium, außen hochglänzend poliert, innen matt gebürstet, induktionsgeeignet

Wok

with flat base, multi layered material incl. aluminium, sandwiched between layers of 18/10 and 18/0 stainless steel, suitable for induction, outside mirror polished

Art-Nr. Part No.	∅ innen ∅ Inside cm	Höhe Height cm	∅ Boden ∅ Base cm	Stiellänge Handle Length cm
523/360	36	9	14	28

Antihft-Beschichtung nicht über 230°C überhitzen.
Please ensure the non-stick surface is never heated above 230°C.



Antihft-Wok

mit abgeflachtem Boden, aus mehrschichtigem Material: Ummantelung aus Edelstahl 18/10 und 18/0, mit PTFE-Antihftbeschichtung, Kern aus Aluminium, außen hochglänzend poliert, induktionsgeeignet

Non-stick Wok

with flat base, multi layered material incl. aluminium, sandwiched between layers of 18/10 and 18/0 stainless steel, with PTFE non-stick coating, suitable for induction, outside mirror polished, heavy gauge

Art-Nr. Part No.	∅ innen ∅ Inside cm	Höhe Height cm	∅ Boden ∅ Base cm	Stiellänge Handle Length cm
5773/300	29	8,5	13	22



Wok

aus Gusseisen, mit abgeflachtem Boden, mit edlem Buchenholzgriff, schwere, hochwertige Qualität

Wok

cast iron, flat base, with high quality wooden handle

Art-Nr. Part No.	∅ oben ∅ Top cm	Höhe Height cm
530/362	24,5	4



Ablage für Wok

aus Edelstahl 18/10, daher auch als Gasring zu verwenden, passend zu allen Woks mit rundem Boden von CONTACTO

Wok Stand

18/10 stainless steel, fits all CONTACTO woks with round base

Kupferkochgeschirr

Das Kupfergeschirr ist technologische Spitze; das Mehrschichtenmaterial sorgt für perfekte Hitzeverteilung. Hochwertiges Design verpackt in echtem Kupfer - typisch **contacto** eben.

Copperware

*Copperware is technologically the leader; the multi-layer material ensures perfect heat distribution. High quality design packed in real copper - typical **contacto**.*

Eine 0,5 mm starke Kupferschicht gibt dieser schweren Serie ihre Wertigkeit. Innen ist 2 mm starkes Mehrschichtmaterial aufgebracht, die das Geschirr uneingeschränkt für alle Lebensmittel geeignet macht. Die Griffe sind aus Edelstahl gefertigt und aufgenietet.

The 0.5 mm thick copper layer gives this range an exclusive quality. The 2 mm 18/10 multi layered material makes it suitable for all kinds of food. The riveted handles are made of stainless steel, as are the lid knobs.



- 0,5 mm starkes Kupfer
- 2 mm Edelstahl/Alu/Edelstahl
- genietete Edelstahlgriffe
- ideal zur Präsentation
- induktionsgeeignet
- 0.5 mm thick copper
- 2 mm multy layered material
- stainless steel handles
- suitable for induction

Kupfer-Flambierpfanne

induktionsgeeignet

Copper Flambé Pan

suitable for induction



Art-Nr. Part No.	∅ innen ∅ Inside cm	Höhe außen Outer Height cm	∅ Boden ∅ Base cm
8773/200	20	4	14
8773/240	24	4,5	18
8773/280	28	5	20

Kupfer-Stielkasserolle

mit Schüttrand, mit Deckel, induktionsgeeignet

Copper Sauté Pan

with pouring rim and lid, suitable for induction



Art-Nr. Part No.	∅ innen ∅ Inside cm	Höhe außen Outer Height cm	∅ Boden ∅ Base cm
8776/160	1,6 l	16	8,5
8776/180	2 l	18	8,5

Kupfer-Sauteuse

mit Schüttrand, induktionsgeeignet

Copper Sauteuse

with pouring rim, suitable for induction



Art-Nr. Part No.	∅ innen ∅ Inside cm	Höhe außen Outer Height cm	∅ Boden ∅ Base cm
8775/200	1,8 l	20	7

Art-Nr. Part No.	∅ innen ∅ Inside cm	Höhe außen Outer Height cm	∅ Boden ∅ Base cm	
8778/280	4 l	28	8	21



Kupfer-Pfanne, tief
induktionsgeeignet
Copper Frying Pan
suitable for induction

Art-Nr. Part No.	∅ innen ∅ Inside cm	Höhe außen Outer Height cm	∅ Boden ∅ Base cm	
8777/200	3,5 l	20	11,5	17,5
8777/240	6,2 l	24	14	21,5



Kupfer-Kochtopf
mit Schüttrand, mit Deckel, induktionsgeeignet
Copper Casserole
with pouring rim and lid, suitable for induction

Art-Nr. Part No.	Länge Length cm	Breite Width cm	Höhe außen Outer Height cm	
8774/350	5,2 l	35	25	6



Kupfer-Bräter
nicht induktionsgeeignet
Copper Gratin Pan
suitable for any cooking method except induction

Art-Nr. Part No.	∅ innen ∅ Inside cm	Höhe außen Outer Height cm	∅ Boden ∅ Base cm	
2808/160	1,4 l	16	7	13,5



Stielkasserolle, Hammerschlag
aus Mehrschichtmaterial mit Edelstahl 18/10,
hochglänzend, induktionsgeeignet, in Hammerschlag-
Optik, mit Griffen und Deckel aus Edelstahl, mit
Schüttrand
Sauce Pan
multi-ply material, 18/10 stainless steel, mirror polished
finish, suitable for any cooking method including
induction, hammered finish, supplied with riveted
stainless steel handles and lid, with pouring rim



Art-Nr. Part No.	∅ innen ∅ Inside cm	Höhe außen Outer Height cm	∅ Boden ∅ Base cm	
2809/240	4,7 l	24	10,5	22



Bratentopf, Hammerschlag
aus Mehrschichtmaterial mit Edelstahl 18/10,
hochglänzend, induktionsgeeignet, in Hammerschlag-
Optik, mit Griffen und Deckel aus Edelstahl, mit
Schüttrand
Braising Pan
multi-ply material, 18/10 stainless steel, mirror polished
finish, suitable for any cooking method including
induction, hammered finish, supplied with riveted
stainless steel handles and lid, pouring rim



Art-Nr. Part No.	∅ innen ∅ Inside cm	Höhe außen Outer Height cm	∅ Boden ∅ Base cm
2803/240	24	5	18



Bratpfanne, Hammerschlag
aus Mehrschichtmaterial mit Edelstahl 18/10,
hochglänzend, induktionsgeeignet, in Hammerschlag-
Optik, mit genietetem Stielgriff aus Edelstahl
Frying Pan
multi-ply material, 18/10 stainless steel, mirror polished
finish, suitable for any cooking method including
induction, hammered finish, supplied with riveted
stainless steel handle



Aluminiumpfannen, Antihaft

So schnell und gleichmäßig kommt die Hitze nur mit Aluminium-Pfannen an das Bratgut. Lassen Sie nichts anbrennen auf den hochwertigen Antihaft-Beschichtungen.

Non-Stick Aluminium Cookware

The heat only reaches the food so quickly and evenly with aluminium pans. Using Contacto's high quality non-stick coatings virtually removes the chances of food sticking and burning.

Aluminiumguss erlaubt spannungsfreie plane Böden und ein leichtes Gesamtgewicht. Durch aufgeschmolzenes Eisenplasma sind induktionsfähige Varianten möglich (bitte achten Sie auf den Induktionshinweis beim Artikel).

Unter der Antihafschicht liegt eine Plasmaschicht aus Titan-Aluminium-Oxyd. Ein hoher Antihaf-Effekt und gute Kratzfestigkeit im Dauereinsatz sind so gewährleistet.

Cast Aluminium results in a flat base and low overall weight. Where a ferritic plasma coating is applied, pans become suitable for induction.

Under the non-stick coating lies an aluminium oxide layer. As a result, these pans have high non-stick and scratch resistant qualities.



- beste Wärmeleitung
- hochwertiger Kokillenguss
- Aluoxid-Antihafgrund
- beste PTFE Beschichtung
- Edelstahl 18/10 Griffe
- robust

- excellent heat conductor
- high end cast aluminium
- aluminum oxide layer
- superb PTFE coating
- 18/10 stainless steel handles
- durable

Lyoner Bratpfanne

nicht induktionsgeeignet

Frying Pan

not suitable for induction



Art-Nr. Part No.	Ø dia. cm	Höhe Height cm	Stiellänge Handle Length cm	Ø Boden Base cm
5508/200	20	3,5	22	17
5508/240	24	3,5	22	18
5508/280	28	5,8	32	19,5
5508/320	32	5,8	32	23,5
5508/360	36	6	38	28
5508/400	40	6	38	31,5

Deckel bitte separat bestellen (Art. 5509 auf Seite 21)
Please order lids no. 5509 on page 21 separately.

Lyoner Bratpfanne, induktionsgeeignet

hoher Wirkungsgrad auf Induktionsstellen durch Spezialbeschichtung

Frying Pan

high performance on induction hobs



Art-Nr. Part No.	Ø dia. cm	Höhe Depth cm	Stiellänge Handle Length cm	Ø Boden Base cm
5578/200	20	3,5	22	17
5578/240	24	3,5	22	18
5578/280	28	5,8	32	19,5
5578/320	32	5,8	32	23,5
5578/360	36	6	38	28
5578/400	40	6	38	31,5

Deckel bitte separat bestellen (Art. 5509 auf Seite 21)
Please order lids no. 5509 on page 21 separately.

Bratpfanne

flache Form, nicht induktionsgeeignet

Frying Pan, shallow

not suitable for induction



Art-Nr. Part No.	Ø dia. cm	Höhe Height cm	Stiellänge Handle Length cm	Ø Boden Base cm
5503/200	20	3	20	17,5
5503/240	24	3	20	20
5503/280*	28	3	20	23
5503/320*	32	3	20	27

*mit Gegengriff

*with extra cast aluminium side handle

Deckel bitte separat bestellen (Art. 5509 auf Seite 21)
Please order lids no. 5509 on page 21 separately.

Art-Nr. Part No.	∅ dia. cm	Höhe Height cm	Stiellänge Handle Length cm	∅ Boden ∅ Base cm
5573/200	20	3	20	17,5
5573/240	24	3	20	20
5573/280	28	3	20	23
5573/320	32	3	20	27

Deckel bitte separat bestellen (Art. 5509 auf Seite 21)
Please order lids no. 5509 on page 21 separately.



Bratpfanne, induktionsgeeignet
flache Form, hoher Wirkungsgrad auf Induktionsstellen durch Spezialbeschichtung

Frying Pan, shallow
high performance on induction hobs

Art-Nr. Part No.	∅ dia. cm	Höhe Height cm	Stiellänge Handle Length cm	∅ Boden ∅ Base cm
5505/200	20	5	20	16
5505/240	24	5	20	18
5505/280	28	5	20	22
5505/320*	32	5	20	30

*mit Gegengriff
*with extra cast aluminium side handle
Deckel bitte separat bestellen (Art. 5509 auf Seite 21)
Please order lids no. 5509 on page 21 separately.



Bratpfanne
mittelhohe Form, nicht induktionsgeeignet

Frying Pan, medium
medium, not suitable for induction

Art-Nr. Part No.	∅ dia. cm	Höhe Height cm	Stiellänge Handle Length cm	∅ Boden ∅ Base cm
5575/200	20	5	20	15
5575/240	24	5	20	18
5575/280	28	5	20	21,5
5575/320	32	5	20	29

Deckel bitte separat bestellen (Art. 5509 auf Seite 21)
Please order lids no. 5509 on page 21 separately.



Bratpfanne, induktionsgeeignet
mittelhohe Form, hoher Wirkungsgrad auf Induktionsstellen durch Spezialbeschichtung

Frying Pan, medium
high performance on induction hobs

Art-Nr. Part No.	∅ dia. cm	Höhe Height cm	Stiellänge Handle Length cm	∅ Boden ∅ Base cm
5507/240*	24	7	20	18
5507/280*	28	7	20	22

*mit Gegengriff
*with extra cast aluminium side handle
Deckel bitte separat bestellen (Art. 5509 auf Seite 21)
Please order lids no. 5509 on page 21 separately.



Bratpfanne
hohe Form, nicht induktionsgeeignet

Frying Pan, deep
deep, not suitable for induction

Art-Nr. Part No.	∅ dia. cm	Höhe Height cm	Stiellänge Handle Length cm	∅ Boden ∅ Base cm
5579/240	24	7	20	18
5579/280	28	7	20	22

Deckel bitte separat bestellen (Art. 5509 auf Seite 21)
Please order lids no. 5509 on page 21 separately.



Bratpfanne, induktionsgeeignet
hohe Form, hoher Wirkungsgrad auf Induktionsstellen durch Spezialbeschichtung

Frying Pan, deep
high performance on induction hobs

Art-Nr. Part No.	∅ dia. cm
5509/200	20 cm
5509/240	24 cm
5509/260	26 cm
5509/280	28 cm
5509/320	32 cm



Glasdeckel
passend zu allen Aluminiumguss- und Edelstahlpfannen von Contacto, bedingt bruchfest, Knopf aus Kunststoff, backofenfest bis +250°C

Glass Lid
matches titanium aluminium oxide range and all Contacto stainless steel pans, knob made of plastic, oven safe up to +250°C



Grillpfanne, quadratisch

Square Griddle Pan



Art-Nr. Part No.	Länge innen Inner Length cm	Breite innen Inner Width cm	Höhe Height cm	Ø Boden Ø Base cm
nicht induktionsgeeignet: / not suitable for induction:				
5504/230	23	23	3	18
5504/250	25	25	7,5	21,5
induktionsgeeignet beschichtet: / coated for induction use:				
5574/230	23	23	3	18

Fischpfanne, oval

Oval Fish Pan



Art-Nr. Part No.	Länge Length cm	Breite Width cm	Höhe Height cm	Stiellänge Handle Length cm
nicht induktionsgeeignet: / not suitable for induction:				
5500/380	38	26	6	20
induktionsgeeignet beschichtet: / coated for induction use:				
5570/380	38	26	6	33

Bratpfanne

nicht induktionsgeeignet

Frying Pan, medium

not suitable for induction



Art-Nr. Part No.	Ø innen Ø Inside cm	Höhe Height cm	Ø Boden Ø Base cm	Stiellänge Handle Length cm
5515/240	24	5	18	27
5515/280	28	5	22	27
5515/320	32	5	26	27

Bratpfanne GN

nicht induktionsgeeignet

GN Roasting Pan

not suitable for induction



Art-Nr. Part No.	Länge Length cm	Breite Width cm	Höhe außen Outer Height cm	GN
5510/325	32,5	26,5	6,5	1/2
5510/530	53	32,5	6,5	1/1

Bräter, oval

mit versetzten Laschengriffen, backofenfest, der Deckel (7 cm hoch) kann separat als Bräter verwendet werden, nicht induktionsgeeignet

Oval Deep Roasting Pan with Lid

the 7 cm high lid can be used as a roasting dish, total height 27 cm



Art-Nr. Part No.	Länge Length cm	Breite Width cm	Höhe gesamt Overall Height cm	
5501/420	42	24	20	9 l

Bräter, rechteckig

mit schwarzen Griffen aus Duroplast, mit Glasdeckel, der auch als Auflaufschale verwendet werden kann, nicht induktionsgeeignet, 15,5 cm Gesamthöhe, backofenfest bis +250°C

Rectangular Roasting Pan

with Duroplast handles and glass lid, oven safe up to +250°C, total height 15.5 cm, oven safe up to +250°C



Art-Nr. Part No.	Länge Length cm	Breite Width cm	Höhe innen Inner Height cm	
5502/330	33	21	11	4 l
Ersatz-Glasdeckel / Spare glass lid:				
5502/331				2,4 l

Art-Nr. Part No.	Ø dia. cm	Höhe außen Outer Height cm	Stärke Thickness mm
5088/200	20	4	5
5088/240	24	4	5
5088/280	28	4	5
5088/320	32	5	5



Antihaft-Lyonerpfanne, induktionsgeeignet

aus Aluminium, mit PTFE-Beschichtung, plangedrehter Spezialboden, Eisengriff dreifach vernietet, induktionsgeeignet

Non-Stick Frying Pan, induction

aluminium with PTFE coating, special ground base, with riveted steel handle, suitable for induction



Art-Nr. Part No.	Ø dia. cm	Höhe außen Outer Height cm	Stärke Thickness mm
5077/200	20	4	4
5077/240	24	4,5	4
5077/280	28	4,5	4
5077/320	32	5	5
5077/360	36	5,5	5
5077/400	40	5,5	5



Antihaft-Lyonerpfanne

aus Aluminium, mit hochwertiger PTFE-Beschichtung, plangedrehter Boden, flacher dreifach vernieteter Edelstahlgriff, nicht induktionsgeeignet

Non-Stick Frying Pan

aluminium with high grade PTFE coating, ground base, with riveted stainless steel handle not suitable for induction



Art-Nr. Part No.	Ø dia. cm	Höhe Height cm	Stiellänge Handle Length cm	Stärke Thickness mm
5066/200	20	3,5	18	4
5066/240	24	4,5	22	4
5066/280	28	5	26	4
5066/320	32	5	26,5	4
5066/360	36	5	31,5	4
5066/400	40	5	31	4



Antihaft-Bratpfanne

aus Aluminium, mit PTFE-Beschichtung, plangedrehter Boden, flacher dreifach vernieteter Eisengriff, nicht induktionsgeeignet

Non-Stick Frying Pan

aluminium, with PTFE coating, ground base, with riveted steel handle, not suitable for induction



Art-Nr. Part No.	Ø dia. cm	Höhe außen Outer Height cm	Stiellänge Handle Length cm	Stärke Thickness mm
6103/200	20	3,5	18	4
6103/240	24	5,5	23	4
6103/280	28	5	28	4
6103/320	32	5,8	28	4
6103/360	36	7,5	32	4
6103/400	40	6,5	34,5	4



Antihaft-Bratpfanne

aus Aluminium, mit PTFE-Beschichtung, plangedrehter Boden, Rundstiel aus Edelstahl, nicht induktionsgeeignet

Non-Stick Frying Pan

deep drawn aluminium with PTFE non-stick coating, ground base, stainless steel handle, not suitable for induction



Antihaft-Fischpfanne

aus Aluminium, mit PTFE-Beschichtung, plangedrehter Boden, Edelstahlgriff dreifach vernietet, nicht induktionsgeeignet

Non-Stick Fish Pan

aluminium with PTFE coating, ground base, with riveted stainless steel handle, not suitable for induction



Art-Nr. Part No.	Länge Length cm	Breite Width cm	Höhe Height cm	Stärke Thickness mm
5076/360	36	25	5	5



Antihaft-Pfanne, hoch

aus Aluminium, mit PTFE-Beschichtung, plangedrehter Boden, Edelstahlgriff dreifach vernietet, nicht induktionsgeeignet

Non-Stick Sauteuse

aluminium with PTFE coating, ground base, with riveted stainless steel handle, not suitable for induction



Art-Nr. Part No.	∅ dia. cm	Höhe Height cm	Stärke Thickness mm
5075/240	24	7	4



Antihaft-Blinispfanne

aus Aluminium, mit PTFE-Beschichtung, plangedrehter Boden, Edelstahlgriff zweifach vernietet, nicht induktionsgeeignet

Non-Stick Blinis Pan

aluminium, with PTFE coating, ground base, with riveted stainless steel handle, not suitable for induction



Art-Nr. Part No.	∅ dia. cm	Höhe Height cm	Stärke Thickness mm
5073/120	12	2	3



Antihaft-Omelettepfanne

aus Aluminium, mit PTFE-Beschichtung, plangedrehter Boden, Edelstahlgriff zweifach vernietet, nicht induktionsgeeignet

Non-Stick Crêpe Pan

aluminium, with PTFE coating, ground base, with riveted stainless steel handle, not suitable for induction



Art-Nr. Part No.	∅ dia. cm	Höhe Height mm	Stärke Thickness mm
5074/260	24	20	3





Eisenpfannen

Kaltgeschmiedete Pfannen gefertigt nach 100 Jahre alter deutscher traditioneller Herstellungsweise. Bratkartoffeln gelingen nirgendwo besser.

Steel Pans

Cold forged pans made in the same way for the past 100 years. The best way to produce fried potatoes - German Bratkartoffeln.



- rustikales Design
- kaltgeschmiedetes Eisen
- hoch erhitzbar
- gut einfetten
- induktionsgeeignet
- *rustic design*
- *cold forged*
- *withstand high temperatures*
- *use sufficient oil*
- *suitable for induction*

Kaltgeschmiedete Pfannen werden kalt, also nicht im rotglühendem Zustand geschmiedet, wodurch die Oberfläche weicher als bei warmgeschmiedeten Pfannen wird, gleichzeitig aber glatter. Das Eisen von geschmiedeten Pfannen ist nicht so spröde und stoßempfindlich wie Gusseisen. Es ist ideal zum schnellen Anbraten bei hoher Energiezufuhr auf allen Herdarten einschließlich Induktion.

Cold Forged Pans have a soft and smooth surface, making them ideally suited for use on ceramic as well as electric, induction and gas hobs. The iron in forged pans is not as rough and is more durable than in cast iron pans. They are ideal for flash frying at very high temperatures.

Art-Nr. Part No.	∅ dia. cm	∅ Boden ∅ Base cm	Höhe Height cm
5259/200	20	14,5	3
5259/240	24	18,5	3
5259/280	27,5	21,5	3,5
5259/320	32	24	3,5
5259/360	36	28	3,5



Brat- und Servier-Eisenpfanne
flache Form, mit zwei Griffen

Iron Frying/Serving Pan
shallow, with two handles

Art-Nr. Part No.	∅ außen ∅ Outside cm	Höhe Height cm	∅ Pfanne ∅ Plate cm
---------------------	----------------------------	----------------------	---------------------------

PRODUKTION
EINGESTELLT
PRODUCTION
DISCONTINUED



Servierständer für Eisenpfannen
Serving Stand for Iron Pans

Art-Nr. Part No.	∅ innen ∅ Inside cm	Höhe außen Outer Height cm	∅ Boden ∅ Base cm
5251/280	28	4,5	21



Brat- und Servier-Eisenpfanne
tiefe Form, mit zwei Griffen

Iron Frying/Serving Pan
deep, with two handles

Brat- und Servier-Eisenpfanne

flache Form, angesetzter Flachgriff mit Haken

Iron Frying/Serving Pan

shallow, flat handle with hook



Art-Nr. Part No.	∅ dia. cm	∅ Boden ∅ Base cm	Höhe Height cm	Stiellänge Handle Length cm
5252/160	16	12	2	17
5252/200	20	14,5	3	21,5
5252/240	24	18,5	3	25
5252/280	28	21,5	3,5	26,5
5252/320	32	24,5	3,5	31
5252/360	36	29	3,5	35,5
5252/400	40	32	3,5	41,5
5252/450	45	38	3,5	45,5

Brat- und Servier- Eisenpfanne

tiefe bauchige Form, angesetzter Flachgriff mit Haken

Iron Frying/Serving Pan

deep, flat handle with hook



Art-Nr. Part No.	∅ dia. cm	∅ Boden ∅ Base cm	Höhe Height cm	Stiellänge Handle Length cm
5250/240	24	18	4	23,5
5250/280	28	21	4,5	26,5

Brat- und Servier-Eisenpfanne

flache Form, mit gebogenem Flachgriff

Iron Frying/Serving Pan

shallow, bent flat handle



Art-Nr. Part No.	∅ dia. cm	∅ Boden ∅ Base cm	Höhe Height cm	Stiellänge Handle Length cm
5253/200	20	14,5	2,5	11
5253/240	24	18,5	3	12,5
5253/280	28	21,5	3	16

Brat- und Servier-Eisenpfanne

flache Form, mit hochstehendem Stiel

Iron Frying/Serving Pan

flat, with upright handle



Art-Nr. Part No.	∅ dia. cm	∅ Boden ∅ Base cm	Höhe Height cm	Stiellänge Handle Length cm
5254/200	20	14,5	2,8	20
5254/240	24	18,5	2,8	23,5

Eisenplatte

unlackiert, auf schwarzem Eisengestell, mit zwei Handgriffen, schwere Qualität

Griddle

mild steel, on wrought black iron frame, with handles each end, heavy gauge



Art-Nr. Part No.	Länge Length cm	Breite Width cm	Höhe Height cm
5087/700	70	41	12



Art-Nr. Part No.	Ø dia. cm	Höhe Depth cm	Stiellänge Handle Length cm
5007/200	20	3	18
5007/240	24	3	21
5007/280	28	3	24



Eisen-Lyoneser Pfanne

aus ungeschwärztem flachen Stahl, mit geschmiedetem Stiel mit Haken, induktionsgeeignet, schwere Qualität

Frying Pan

mild steel, with blue steel handle, suitable for any cooking method including induction, heavy gauge



Art-Nr. Part No.	Ø dia. cm	Höhe Depth cm	Stiellänge Handle Length cm
5003/200	20	4	16
5003/240	24	4	17
5003/280	28	4,5	22
5003/320	32	5	25,5
5003/360	36	5,5	31
5003/400	40	6	31
5003/500	50	6	41



Eisen-Lyoneser Pfanne

aus 2,5 bis 3 mm starkem ungeschwärzten Stahl, gebläuter Flachgriff mit Aufhängeöse, induktionsgeeignet, schwere Qualität

Frying Pan

2.5 - 3 mm mild steel, flat blue steel handle, with hanging loop, suitable for any cooking method including induction, heavy gauge



Art-Nr. Part No.	Ø dia. cm	Höhe Height cm
5080/340	34	5
5080/420	42	5,5
5080/470	47	6,5
5080/600	60	6,5



Paellapfanne

aus 1,5 mm starkem gebläutem Stahl, mit zwei ungeschwärzten Griffen, induktionsgeeignet, schwere Qualität

Paella Pan

1.5 mm thick blue steel, two mild steel handles, suitable for any cooking method including induction, heavy gauge



Art-Nr. Part No.	Ø dia. cm	Höhe Height cm
5080/240	24	4
5080/400	40	6



Paellapfanne

aus 2,5 mm starkem ungeschwärzten Stahl, mit zwei Griffen, induktionsgeeignet, schwere Qualität

Paella Pan

2.5 mm thick mild steel, two handles, suitable for induction, heavy gauge



Art-Nr. Part No.	Ø dia. cm	Höhe Depth cm	Stiellänge Handle Length cm
5100/200	20	2	18
5100/240	24	2	20
5100/280	28	3	22



Eisen-Crêpes-Pfanne

Omelettepfanne, aus ungeschwärztem Stahl, Materialstärke 2 mm, gebläuter Flachgriff mit Aufhängeöse, induktionsgeeignet, schwere Qualität

Crêpe Pan

mild steel, 2 mm flat blue steel handle with hanging loop, suitable for any cooking method including induction, heavy gauge



Art-Nr. Part No.	Ø dia. cm	Höhe Depth cm	Stiellänge Handle Length cm
5030/120	12	2,5	12,5



Eisen-Blinispfännchen

aus 2,5 mm starkem ungeschwärztem Stahl, gebläuter Flachgriff mit Aufhängeöse, schwere Qualität

Blinis Pan

2.5 mm thick mild steel, flat blue steel handle with hanging loop, heavy gauge





Gusseiserne Pfannen

Diese Pfannen eignen sich besonders gut zum scharfen Anbraten und mit jeder Benutzung werden die Ergebnisse besser. Der Eisenguss lässt sich sehr hoch anheizen, die Poren des Steaks schließen sich sofort.

Cast Iron Pans

These pans are particularly good for searing steak, and with each use, the results get better. Cast iron can be heated to a very high temperature, perfect for searing meat fast.

Diese Pfannen werden nach traditioneller skandinavischer Handwerkskunst hergestellt.

Gusseisen verteilt die Wärme nur langsam aber hält sie dann gleichmäßig auch bei hohen Temperaturen. Das ist besonders bei Steaks nützlich oder bei langem und konstantem Schmoren. Die Pfannenböden sind plangedreht und liegen im erhitztem wie auch erkaltetem Zustand immer eben auf. Auf Induktionsflächen sind diese Pfannen nur bedingt einsetzbar.

Cast iron has long been recognised as one of the best materials available for cookware, for use on any heat source except for most induction hobs. It makes very versatile cookware, suitable for slow cooking and gentle simmering, boiling, searing, grilling or frying. Cast iron retains heat and promotes gentle, even cooking on low heat.



- 100%iges robustes Eisen
- fehlerfreie Oberfläche
- plangedrehte Böden
- Edelstahl 18/10 Griffe
- schwerste Profiqualität
- *robust 100% iron*
- *error-free surface*
- *ground base*
- *stainless steel handles*
- *very heavy gauge*

Bratpfanne, flach Frying Pan, shallow



Art-Nr. Part No.	∅ innen ∅ Inside cm	Höhe Height cm	Stiellänge Handle Length cm	∅ Boden ∅ Base cm
5775/180	18	3	17	13
5775/240	24	3,5	17	19
5775/260	26	3,5	17	20
5775/280	28	3,5	18	22
5775/340	34	4,5	18	28

Bratpfanne, tief Frying Pan, deep



Art-Nr. Part No.	∅ innen ∅ Inside cm	Höhe Depth cm	Stiellänge Handle Length cm	∅ Boden ∅ Base cm
5770/270	28	4,8	18	24

Grillpfanne, rund stark gerillte Bodenfläche Round Griddle Pan fluted



Art-Nr. Part No.	∅ innen ∅ Inside cm	Höhe Depth cm	Stiellänge Handle Length cm	∅ Boden ∅ Base cm
5777/270	27	4,5	18	23,5



Art-Nr. Part No.	Größe Size cm	Höhe Height cm	Stiellänge Handle Length cm
5756/280	29 x 20	4	20



Steakpfanne, rechteckig
stark gerillte Bodenfläche
Rectangular Griddle Pan
ridged

Art-Nr. Part No.	Größe Size cm	Höhe Height cm	∅ Boden ∅ Base cm
5776/240	24 x 24	3	22



Grillpfanne, quadratisch
stark gerillte Bodenfläche
Square Griddle Pan
ridged

Art-Nr. Part No.	Länge Length cm	Breite Width cm	GN
5751/365	35,5	32,5	2/3

PRODUKTION
EINGESTELLT
PRODUCTION
DISCONTINUED



Brat - und Grillplatte GN 2/3
GN 2/3 Griddle, double sided
ridged one side, plain the other side

Art-Nr. Part No.	Länge innen Inner Length cm	Breite innen Inner Width cm	Höhe Height cm	∅ Boden ∅ Base cm
5771/330	32,5	21,5	4	17

PRODUKTION
EINGESTELLT
PRODUCTION
DISCONTINUED



Ovale Fischpfanne
ganz aus Gusseisen
Oval Fish Pan
all cast iron

Art-Nr. Part No.	∅ innen ∅ Inside cm	Höhe Height cm	Stiellänge Handle Length cm	∅ Boden ∅ Base cm
5762/230	23	1,5	16	21,5



Pfannkuchenpfanne
extra flach, ganz aus Gusseisen
Crêpe Pan
flat, all cast iron

Art-Nr. Part No.	∅ innen ∅ Inside cm	Höhe Height cm	Stiellänge Handle Length cm	∅ Boden ∅ Base cm
5765/230	23	1,5	17	18,5



Blinispfännchen
ganz aus Gusseisen,
für sieben kleine Pfannkuchen mit ∅ 7 cm
Blinis Pan
all cast iron, for 7 blinis of ∅ 7 cm

Eierpfanne

ganz aus Gusseisen, für vier Spiegeleier oder kleine Pfannkuchen mit Ø 9,5 cm

Egg Pan

all cast iron, for 4 eggs of Ø 9.5 cm



Art-Nr. Part No.	Länge außen Outer Length cm	Breite außen Outer Width cm	Höhe Height cm	Ø Boden Ø Base cm
5766/200	20,5	20,5	1,5	19

PRODUKTION
EINGESTELLT
PRODUCTION
DISCONTINUED

Förtchenpfanne

auch für Schnecken, Dalken, ganz aus Gusseisen, mit sieben halbrunden Vertiefungen mit Ø 6 cm

Snail Pan

all cast iron, for 7 snails of Ø 6 cm



Art-Nr. Part No.	Ø außen Ø Outside cm	Höhe Height cm	Stiellänge Handle Length cm	Ø Boden Ø Base cm
5767/007	21	3,8	16,5	16,5

PRODUKTION
EINGESTELLT
PRODUCTION
DISCONTINUED

Runder Bräter mit Glasdeckel

backofenfest bis +250°C, Knopf aus Gusseisen

Casserole with Glass Lid

lid oven safe up to +250°C, cast iron knob



Art-Nr. Part No.	Ø innen Ø Inside cm	Höhe außen Outer Height cm	Ø Boden Ø Base cm	
5779/240	24	8,5	19,5	3 l
5779/320	28	11	24	5,5 l

Ersatzdeckel auf Anfrage.
Spare lids on request.

Bratpfanne, tief, induktionsgeeignet

aus Gusseisen, Boden abgedreht, dadurch leichter und induktionsgeeignet, genieteteter Griff mit Gummibeschichtung

Frying Pan, induction

ground base, lighter weight than normal cast iron, rubber coated handle



Art-Nr. Part No.	Ø innen Ø Inside cm	Höhe Depth cm	Stiellänge Handle Length cm	Ø Boden Ø Base cm
5757/240	24	5	22	16
5757/280	28	5,5	22	18
5757/300	30	6	22	20



Grillpfanne, induktionsgeeignet

aus Gusseisen, gerillte Bratfläche, Boden abgedreht, dadurch leichter und induktionsgeeignet, genieteteter Griff mit Gummibeschichtung

Griddle Pan, induction

ground base, ridged, lighter weight than normal cast iron, rubber coated handle



Art-Nr. Part No.	Ø innen Ø Inside cm	Höhe Depth cm	Stiellänge Handle Length cm	Ø Boden Ø Base cm
5757/240	24	5	22	16
5757/280	28	5,5	22	18
5757/300	30	6	22	20

PRODUKTION
EINGESTELLT
PRODUCTION
DISCONTINUED



Art-Nr. Part No.	∅ außen ∅ Outside cm	∅ innen ∅ Inside cm	Höhe Height cm
---------------------	----------------------------	---------------------------	----------------------

Für Pfannen mit max. Boden-∅ 13,5 cm:

Suitable for pans max. base ∅ 13.5 cm:

5763/170	17	14,5	1,5
----------	----	------	-----

Für Pfannen mit max. Boden-∅ 18,5 cm:

Suitable for pans max. base ∅ 18.5 cm:

5763/215	21,5	19	1,5
----------	------	----	-----

Für Pfannen mit max. Boden-∅ 21 cm:

Suitable for pans max. base ∅ 21 cm:

5763/240	24	21,5	1,5
----------	----	------	-----



Korkuntersetzer

aus hellem Naturkorkgranulat, geeignet u.a. für Eisenpfannen

Cork Mat

granulated light natural cork, for iron pans



Art-Nr. Part No.	∅ dia. cm	Höhe Height cm
---------------------	-----------------	----------------------

5764/220	19,5	1
----------	------	---



Korkuntersetzer mit Magnet

aus hellem Naturkorkgranulat, mit Magnetkern, besonders geeignet für Eisenpfannen und induktionsgeeignetes Kochgeschirr, Untersetzer haftet magnetisch und dadurch rutschfest am Topf-/Pfannenboden, nicht spülmaschinengeeignet

Magnetic Cork Mat

granulated light natural cork, with magnetic core, particularly suitable for cast iron and mild steel pans, suitable for induction hob, not dishwasher safe



Art-Nr. Part No.	∅ dia. cm	Höhe Height cm
---------------------	-----------------	----------------------

5257/240	24,5	2
----------	------	---



Korkuntersetzer

für Servierpfannen

Cork Mat

for serving pans



Art-Nr. Part No.	∅ dia. cm	Höhe Height cm
---------------------	-----------------	----------------------

5258/250	25	1,4
----------	----	-----



Untersetzer aus Holz

aus unbehandeltem, naturbelassenem Buchenholz, Oberfläche fein geschliffen, mit Safrinrinne, nicht spülmaschinengeeignet

Wooden Board

natural beechwood, not dishwasher safe



Art-Nr. Part No.	∅ außen ∅ Outside cm	Stiellänge Handle Length cm
---------------------	----------------------------	-----------------------------------

3103/330	33	18
----------	----	----



Pfannen-Fettspritzschutz

aus Edelstahl 18/10, sehr feines Gewebe (16 Löcher/cm), spülmaschinengeeignet, stabile Qualität

Splatter Guard

18/10 stainless steel, super fine gauze (16 holes/cm), dishwasher safe, sturdy construction



Eisenguss-Riesenpfanne

hochqualitatives Produkt, aus deutscher Fertigung

Large Frying Pan

cast iron



Art-Nr. Part No.	∅ dia. cm	Höhe Height cm	Gewicht Weight kg
---------------------	-----------------	----------------------	-------------------------

mit zwei angegossenen Griffen: / with two fixed handles:

5090/500 50 7 15

mit einem angegossenen und einem abnehmbarem Griff: / with one fixed and one removable handle:

5091/550 55 8 23

Eisenguss-Riesenpfanne

hochqualitatives Produkt, aus deutscher Fertigung

Large Frying Pan

cast iron



Art-Nr. Part No.	∅ dia. cm	Höhe Height cm	Gewicht Weight kg
---------------------	-----------------	----------------------	-------------------------

mit einem angegossenen und einem abnehmbarem Griff: / with one fixed and one removable handle:

5091/650 65 9 28

mit einem abnehmbaren Griff und einem großen angegossenen Doppelgriff: / with two fixed and one removable handle

5091/800 80 12 45

Versand nur per Spedition möglich.
Pallet delivery only.

Eisenguss-Riesenpfanne

hochqualitatives Produkt, aus deutscher Fertigung,
Länge des abnehmbaren Stiels: 48 cm

Large Frying Pan

cast iron, both include one removable long handle
(48 cm)



Art-Nr. Part No.	∅ dia. cm	Höhe Height cm	Gewicht Weight kg
---------------------	-----------------	----------------------	-------------------------

mit einem abnehmbaren Stiel und einem angegossenen Griff: / with one removable and one fixed handle:

5092/550 55 8 23

mit einem abnehmbaren Stiel und einem großen angegossenen Doppelgriff:

/ with one removable and one fixed double handle:

5092/800 80 12 45

Versand nur per Spedition möglich.
Pallet delivery only.

Eisenguss-Riesenpfanne mit Mittelsteg

hochqualitatives Produkt, aus deutscher Fertigung

Large Frying Pan

cast iron, 2-division



Art-Nr. Part No.	∅ dia. cm	Höhe Height cm	Gewicht Weight kg
---------------------	-----------------	----------------------	-------------------------

mit einem abnehmbaren und zwei angegossenen Griffen: / with one removable and two fixed handles:

5093/650 65 9 29

mit einem abnehmbaren Griff und einem großen angegossenen Doppelgriff: / with one removable and one fixed double handle:

5093/800 80 12 48

Versand nur per Spedition möglich.
Pallet delivery only.

Eisenguss-Riesenpfanne mit Mittelsteg

hochqualitatives Produkt, aus deutscher Fertigung,
Länge des abnehmbaren Stiels: 48 cm

Large Frying Pan

cast iron, 2-division, includes one removable long
handle (48 cm)



Art-Nr. Part No.	∅ dia. cm	Höhe Height cm	Gewicht Weight kg
---------------------	-----------------	----------------------	-------------------------

mit einem abnehmbaren Stiel und einem großen angegossenen Doppelgriff: / with one removable and one fixed double handle:

5094/800 80 12 48

Versand nur per Spedition möglich.
Pallet delivery only.

GastroNorm

Das Gastronorm-System basiert auf Normgrößen die in der DIN EN 631 definiert sind. Die Behälter, Tablettts oder Körbe sind in den entsprechenden Wagen, Theken oder Kochgeräten einsetzbar. Auf den folgenden Seiten finden Sie unsere Gastronorm-Behälter aus Edelstahl, Polypropylen und Polycarbonat.

Gastronorm

The Gastronorm system is based on standard sizes defined in DIN EN 631. The containers, trays or baskets can be used in appropriate trolleys, counters, fridges, freezers or cooking appliances. In this section you will find our Gastronorm containers made of stainless steel, polypropylene and polycarbonate.

Seite Page
34



GastroNorm Edelstahl
Stainless Steel Gastronorm

Seite Page
44



GastroNorm Polypropylen
Polypropylene Gastronorm

Seite Page
48



GastroNorm Polycarbonat
Polycarbonate Gastronorm



GastroNorm Edelstahl

Die **contacto** GN-Serien aus Edelstahl zeichnen sich durch ihre solide und langlebige Qualität aus. Die GN-Behälter und Deckel sind die perfekten Begleiter in der Küche und im Catering.

Stainless Steel Gastronorm

The **contacto** stainless steel GN ranges are characterised by their solid and long lasting quality. The GN containers and lids are the perfect companions in the kitchen and for outside catering.

Die GastroNorm-Maße der DIN und europäischen EN 631-1 Norm beziehen sich auf den Referenzbehälter 1/1 mit der Größe 530 x 325 mm.

Gastronorm dimensions match the European Standard EN 631-1 and refer to the basic 1/1 full size module of 530 x 325 mm.

Die Maße der Norm sind immer Außenmaße, damit sichergestellt ist, dass die Behälter in die Systemeinstellungen wie Konvektomatenöfen, Kombidämpfer oder Auslagen passen.

Measurements are always external, so that one can be certain, that the containers or trays will fit whatever they are put into, e.g. gastronorm trolleys.



- hochwertiges Material
- schwere Qualität
- stapelbar
- kompatibel
- hygienisch

- high quality
- heavy gauge
- stackable
- compatible
- hygienic

Die Abmessungen: The Measurements:

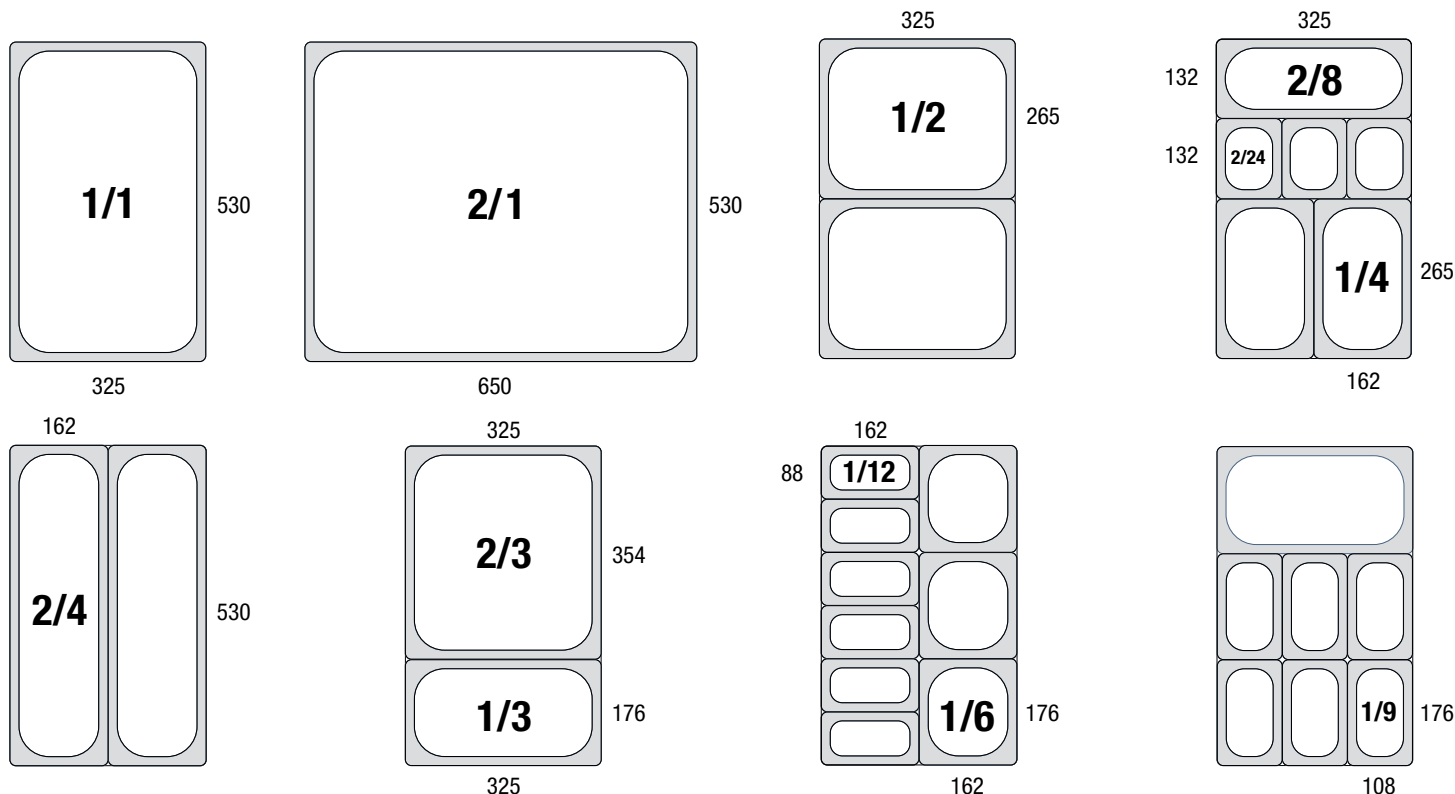

Alle Maßangaben in mm.
All measurements are in mm.



Art-Nr. Part No.	Tiefe Depth mm		GN
7011/020	20	2,5 l	1/1
7011/040	40	5 l	1/1
7011/055	55	6,2 l	1/1
7011/065	65	9 l	1/1
7011/100	100	14 l	1/1
7011/150	150	21 l	1/1
7011/200	200	28 l	1/1
7012/020	20	1,25 l	1/2
7012/040	40	2,5 l	1/2
7012/065	65	4 l	1/2
7012/100	100	5,7 l	1/2
7012/150	150	8,7 l	1/2
7012/200	200	11 l	1/2
7013/020	20	0,75 l	1/3
7013/040	40	1,5 l	1/3
7013/065	65	2,5 l	1/3
7013/100	100	4 l	1/3
7013/150	150	5,7 l	1/3
7013/200	200	7,8 l	1/3
7014/020	20	0,5 l	1/4
7014/040	40	1 l	1/4
7014/065	65	1,8 l	1/4
7014/100	100	2,8 l	1/4
7014/150	150	4 l	1/4
7014/200	200	5,5 l	1/4
7016/065	65	1 l	1/6
7016/100	100	1,6 l	1/6
7016/150	150	2,4 l	1/6
7016/200	200	3,4 l	1/6
7019/065	65	0,6 l	1/9
7019/100	100	1 l	1/9
7019/150	150	1,5 l	1/9
7021/020	20	5 l	2/1
7021/040	40	10 l	2/1
7021/065	65	18,5 l	2/1
7021/100	100	28,5 l	2/1
7021/150	150	42,5 l	2/1
7021/200	200	57,5 l	2/1
7023/020	20	1,5 l	2/3
7023/040	40	3 l	2/3
7023/065	65	5,5 l	2/3
7023/100	100	9 l	2/3
7023/150	150	13 l	2/3
7023/200	200	18 l	2/3
7024/020	20	1,25 l	2/4
7024/040	40	2,4 l	2/4
7024/065	65	3,5 l	2/4
7024/100	100	6 l	2/4
7024/150	150	8,75 l	2/4
7028/020	20	0,5 l	2/8
7028/040	40	1 l	2/8
7028/065	65	1,8 l	2/8
7028/100	100	2,8 l	2/8
7028/150	150	3,7 l	2/8
7112/100	100	0,6 l	1/12
7124/100	100	0,75 l	2/24

GN-Behälter Serie 7000

aus Edelstahl 18/10, Ausgangsmaterialstärke: 0,8 mm, DIN 66075 bzw. EuroNorm 631-1, stapelbar, schwere Qualität. Die GastroNorm-Behälter von CONTACTO sind kompatibel zu dem deutschen Industriestandard. Deckel bitte separat bestellen.

GN Containers 7000 Range

18/10 stainless steel, material thickness: 0.8 mm, conforms to EN 631-1, stackable, heavy gauge. Please order lids separately.



GN-Systemmaße siehe Seite 34
See page 34 for GN System sizes.

GN-Behälter, perforiert Serie 7311

aus Edelstahl 18/10, DIN 66075 bzw. EuroNorm 631-1, stapelbar, gelochte Bodenfläche, ab 100 mm Tiefe zusätzlich mit Wandlochung, Lochdurchmesser 3 mm, schwere Qualität

Perforated GN Containers 7311

18/10 stainless steel, conforms to EN 631-1, stackable with side perforations from 100 mm depth, 3 mm perforations, ideal for steaming vegetable etc., heavy gauge



Art-Nr. Part No.	Tiefe Depth mm		GN
7311/020*	20	2,5 l	1/1
7311/040*	40	5 l	1/1
7311/065*	65	9 l	1/1
7311/100	100	14 l	1/1
7311/150	150	21 l	1/1
7311/200	200	28 l	1/1
7312/040*	40	2 l	1/2
7312/065*	65	4 l	1/2
7312/100	100	6,5 l	1/2
7312/150	150	9,5 l	1/2
7312/200	200	12,5 l	1/2
7313/065*	65	2,5 l	1/3
7313/100	100	4 l	1/3
7314/065*	65	1,8 l	1/4
7314/100	100	2,8 l	1/4
7314/150	150	4 l	1/4
7323/020*	20	1,5 l	2/3
7323/040*	40	3 l	2/3
7323/065*	65	5,5 l	2/3
7323/100	100	9 l	2/3
7323/150	150	13 l	2/3
7323/200	200	18 l	2/3
7321/065*	65	18,5 l	2/1
7321/100	100	28,5 l	2/1

*Nur Bodenlochung.

*base perforation only

Andere Größen auf Anfrage erhältlich. GN-Systemmaße siehe Seite 34.
Further sizes available on request. See page 34 for GN system sizes.

Antihaft-GN-Behälter

aus Edelstahl 18/10, DIN 66075 bzw. EuroNorm 631-1, innen mit PTFE-Antihftbeschichtung, stapelbar

Non-Stick GN Containers

18/10 stainless steel, conform to EN 631-1, inside with PTFE coating, stackable



Art-Nr. Part No.	Tiefe Depth mm		GN
6411/020	20	2,5 l	1/1
6411/040	40	5 l	1/1
6411/065	65	9 l	1/1

Deckel bitte separat bestellen. GN-Systemmaße siehe Seite 34.
Please order lids separately. See page 34 for GN system sizes.

GN 1/1 Abteilbehälter

aus Edelstahl, matt, schwere Qualität, unterteilt in zwei Abteile, ideal z.B. für Chafing Dish

GN 1/1 Two Division container

stainless steel, matt polished finish heavy gauge



Art-Nr. Part No.	Tiefe Depth mm		GN
7010/011	65	3 l	1/1

Bei Bedarf passende Deckel zweimal GN 1/2 separat bestellen von Seite 37: / Takes two 1/2 size GN lids, please order separately from page 37:

7512/325			1/2
----------	--	--	-----

Art-Nr.	GN
Part No.	
7511/530	1/1
7512/325	1/2
7513/325	1/3
7514/265	1/4
7516/176	1/6
7517/162	1/12
7519/176	1/9
7520/132	2/24
7521/650	2/1
7523/352	2/3
7524/162	2/4
7528/325	2/8

GN-Systemmaße siehe Seite 34.
See page 34 for GN system sizes.



GN-Deckel für Serie 7000

aus Edelstahl 18/10, seidenmatt poliert, mit Griffmulde, passen auch auf Serien 7300, 6400, 8600, schwere Qualität

GN Lids for 7000 Range

18/10 stainless steel, satin polished finish, with handle, the lids fit as well the 7300, 6400, 8600, heavy gauge



Art-Nr.	GN
Part No.	
7611/530	1/1
7612/325	1/2
7613/325	1/3
7614/265	1/4
7616/176	1/6
7619/176	1/9
7623/352	2/3
7624/162	2/4

GN-Systemmaße siehe Seite 34
See page 34 for GN system sizes.



GN-Deckel mit Ausschnitt für Löffel

für Serie 7000, aus Edelstahl 18/10, seidenmatt poliert, mit Griffmulde, passend auch auf Serien 7300, 6400, 8600

GN Lids - notched for spoon

for 7000 range, 18/10 stainless steel, satin polished finish, with handle, lids also fit 7300, 6400, 8600



Art-Nr.	GN
Part No.	
8411/530	1/1
8412/325	1/2
8413/325	1/3
8414/265	1/4
8416/176	1/6
8423/352	2/3
8424/162	2/4

GN-Systemmaße siehe Seite 34
See page 34 for GN system sizes.



GN-Deckel mit Gummidichtung

aus Edelstahl 18/10, seidenmatt poliert, mit Griffmulde und Loch gegen Unterdruck, hitzebeständig bis +150°C, die Gummidichtung schützt den Deckel gegen mechanische Stöße, spülmaschinene geeignet. Die Deckel passen auf die GN Behälter 7000 und 8600 ab 65 mm Tiefe, sind aber nicht mit den Polycarbonat- und Polypropylen-GN-Behältern kombinierbar.

GN Lids with Rubber Seal

18/10 stainless steel, satin polished finish, with handle and pressure vent, can be used in temperatures up to +150°C, the rubber protects the lids edges, dishwasher safe. Lids fit the 7000 and 8600 GN containers deeper than 65 mm, but do not fit our polycarbonate or polypropylene GN containers.



Art-Nr.	GN
Part No.	
7910/011	1/1
7910/012	1/2
7910/013	1/3
7910/014	1/4
7910/016	1/6
7910/019	1/9

GN-Systemmaße siehe Seite 34
See page 34 for GN system sizes.



GN-Deckel aus Polycarbonat für Edelstahlbehälter

passend auf die GN-Behälter aus Edelstahl von CONTACTO (Serien 7000 und 8600)

Polycarbonate GN Lid

matches the stainless steel containers from CONTACTO 7000 and 8600 ranges



GN-Behälter mit Fallgriffen

Serie 7200, aus Edelstahl 18/10, DIN 66075 bzw. EuroNorm 631-1, stapelbar

GN Containers with Drop Down Handles

7200 range, 18/10 stainless steel, conform to EN 631-1, stackable



Art-Nr. Part No.	Tiefe Depth mm		GN
7211/065	65	9 l	1/1
7211/100	100	14 l	1/1
7211/150	150	21 l	1/1
7211/200	200	28 l	1/1
7212/100	100	6,5 l	1/2
7212/150	150	9,5 l	1/2
7212/200	200	12,5 l	1/2
7213/100	100	4 l	1/3
7213/150	150	5,7 l	1/3
7213/200	200	7,8 l	1/3
7214/100	100	2,8 l	1/4
7214/150	150	4 l	1/4
7214/200	200	5,5 l	1/4
7216/100	100	1,6 l	1/6
7216/150	150	2,4 l	1/6
7216/200	200	3,4 l	1/6
7223/200	200	18 l	2/3
7224/065	65	3,6 l	2/4
7224/100	100	5,6 l	2/4
7224/150	150	8,5 l	2/4

Deckel der Serie 7711 oder 7811 (mit Löffelausschnitt) bitte separat bestellen.
GN-Systemmaße siehe Seite 34.
Please order lids separately.
See page 34 for GN system sizes.

GN-Deckel für Serie 7200

mit Aussparung für Fallgriffe, aus Edelstahl 18/10, seidenmatt poliert, mit Griffmulde

GN Lids for 7200 Range

notched for handles, 18/10 stainless steel, satin polished finish, with handle



Art-Nr. Part No.	GN
7711/530	1/1
7712/325	1/2
7713/325	1/3
7714/265	1/4
7716/176	1/6
7723/352	2/3
7724/162	2/4

GN-Systemmaße siehe Seite 34
See page 34 for GN system sizes.

GN-Deckel für Serie 7200

mit Aussparung für Löffel und Fallgriffe, aus Edelstahl 18/10, seidenmatt poliert, mit Griffmulde

GN Lids for 7200 Range

notched for spoon and handles, 18/10 stainless steel, satin polished finish, with handle



Art-Nr. Part No.	GN
7811/530	1/1
7812/325	1/2
7813/325	1/3
7814/265	1/4
7816/176	1/6
7823/352	2/3
7824/162	2/4

GN-Systemmaße siehe Seite 34.
See page 34 for GN system sizes.



Art-Nr. Part No.	Tiefe Depth mm	GN	
6711/100	100	14 l	1/1
6711/150	150	21 l	1/1
6711/200	200	28 l	1/1
6712/100	100	6,5 l	1/2
6712/150	150	9,5 l	1/2
6712/200	200	12,5 l	1/2
6713/100	100	4 l	1/3
6713/150	150	5,7 l	1/3
6713/200	200	7,8 l	1/3



GN-Behälter mit Bügelgriffen

Serie 6700, aus Edelstahl 18/10, DIN 66075 bzw. EuroNorm 631-1, stapelbar

GN Containers with Folding Handles

6700 range, 18/10 stainless steel, conforms to EN 631-1, stackable



Es passen nur die Deckel der Serie 6729 und der Serie 8411 (mit Gummidichtung) auf diese Behälter.

Only lids of our 6729 and 8411 (rubber sealed) range are match these containers.

Art-Nr. Part No.	GN
6729/011	1/1
6729/012*	1/2
6729/013**	1/3

*mit 4 Aussparungen für Bügel

**mit 2 Aussparungen für Bügel

*with 4 notches for handles

**with 2 notches for handles



GN-Deckel für Serie 6700

passend zu GN mit Bügelgriffen, aus Edelstahl 18/10, seidenmatt poliert, mit Griffmulde, speziell für GN-Behälter mit Bügel

GN Lids for 6700 range

18/10 stainless steel, satin polished finish, with handle,



Art-Nr. Part No.	für GN for GN	Höhe Height cm	Länge Length cm	Breite Width cm	Loch Hole m m
8111/530	1/1	1,7	46	26,5	10
8112/325	1/2	3	25	20	10
8113/325	1/3	1,7	28	13	6

GN-Systemmaße siehe Seite 34
See page 34 for GN system sizes.



GN-Einlegeböden, gelocht

aus Edelstahl 18/10, schwere Qualität

Trivet/ Drainer Plates

18/10 stainless steel, heavy gauge



GN-Behälter Serie 8600

aus Edelstahl, DIN 66075 bzw. EuroNorm 631-1, stapelbar, Ausgangsmaterialstärke 0,6-0,8 mm, teilweise mit Randverstärkung
Deckel 8711 bitte separat bestellen.

GN Containers 8600

stainless steel, material thickness: 0.6-0.8 mm, conforms to EN 631-1, stackable.
Please order lids 8711 separately.



Art-Nr. Part No.	Tiefe Depth mm		GN
8611/020	20	2,5 l	1/1
8611/040	40	5 l	1/1
8611/065	65	9 l	1/1
8611/100	100	14 l	1/1
8611/150	150	21 l	1/1
8611/200	200	28 l	1/1
8612/020	20	1,25 l	1/2
8612/040	40	2 l	1/2
8612/065	65	4 l	1/2
8612/100	100	6,5 l	1/2
8612/150	150	9,5 l	1/2
8612/200	200	12,5 l	1/2
8613/020	20	0,75 l	1/3
8613/040	40	1,5 l	1/3
8613/065	65	2,5 l	1/3
8613/100	100	4 l	1/3
8613/150	150	5,7 l	1/3
8613/200	200	7,8 l	1/3
8614/065	65	1,8 l	1/4
8614/100	100	2,8 l	1/4
8614/150	150	4 l	1/4
8614/200	200	5,5 l	1/4
8616/065	65	1 l	1/6
8616/100	100	1,6 l	1/6
8616/150	150	2,4 l	1/6
8616/200	200	3,4 l	1/6
8619/065	65	0,6 l	1/9
8619/100	100	1 l	1/9
8619/150	150	1,5 l	1/9
8623/020	20	1,5 l	2/3
8623/040	40	3 l	2/3
8623/065	65	5,5 l	2/3
8623/100	100	9 l	2/3
8623/150	150	13 l	2/3

GN-Deckel für Serie 8600

aus Edelstahl, seidenmatt poliert, mit Griffmulde

GN-Lids for 8600

stainless steel, satin polished finish, with handle



Art-Nr. Part No.	GN
8711/530	1/1
8712/325	1/2
8713/325	1/3
8714/265	1/4
8716/176	1/6
8719/176	1/9
8723/352	2/3

GN-Behälter, perforiert Serie 6111

aus Edelstahl, DIN 66075 bzw. EuroNorm 631-1, Boden- und Seitenlochung ab 100 mm Tiefe, Lochdurchmesser 4 mm, stapelbar, Ausgangsmaterialstärke 0,6-0,8 mm, mittelschwere Qualität

Perforated GN Containers 6111

stainless steel, conforms to EN 631-1, stackable with side perforations from 100 mm depth, 4 mm perforations, ideal for steaming vegetable etc., material thickness 0,6-0,8 mm, medium gauge



Art-Nr. Part No.	Tiefe Depth mm		GN
6111/065*	65	9 l	1/1
6111/100	100	14 l	1/1
6111/150	150	21 l	1/1
6111/200	200	28 l	1/1
6112/065*	65	4 l	1/2
6112/100	100	6,5 l	1/2
6112/150	150	9,5 l	1/2
6112/200	200	12,5 l	1/2
6113/065*	65	2,5 l	1/3
6113/100	100	4 l	1/3
6123/065*	65	5,5 l	2/3
6123/100	100	9 l	2/3

*nur mit Bodenlochung

*base perforation only

Art-Nr. Part No.	Tiefe Depth	GN
7411/010	10 mm	1/1
7411/020	20 mm	1/1
7411/040	40 mm	1/1
7411/065	65 mm	1/1

7412/010	10 mm	1/2
7412/020	20 mm	1/2
7412/040	40 mm	1/2
7412/065	65 mm	1/2

7421/010	10 mm	2/1
7421/020	20 mm	2/1
7421/040	40 mm	2/1
7421/065	65 mm	2/1

7423/010	10 mm	2/3
7423/020	20 mm	2/3
7423/040	40 mm	2/3
7423/065	65 mm	2/3

GN-Systemmaße siehe Seite 34
See page 34 for GN system sizes.



GN-Konvektomatenblech
aus Edelstahl 18/10, schwere Qualität

GN- Combi Oven Trays
18/10 stainless steel, heavy gauge



Art-Nr. Part No.	Tiefe Depth	GN
7115/020	20 mm	1/1
7115/040	40 mm	1/1
7115/065	65 mm	1/1

7125/040	40 mm	1/2
7125/065	65 mm	1/2

7135/065	65 mm	1/3
----------	-------	-----

GN-Systemmaße siehe Seite 34
See page 34 for GN system sizes.



GN-Konvektomatenblech
aus Stahlblech, beidseitig beschichtet mit schwarzer
Granit-Emaille, in zwei Ecken gelocht, schwere Qualität

GN Combi Oven Trays - enameled
mild steel, both sides coated with black granite enamel,
pierced in 2 corners, heavy gauge



Art-Nr. Part No.	Tiefe Depth	GN
7110/020	20 mm	1/1
7110/040	40 mm	1/1
7110/065	65 mm	1/1

7117/010	10 mm	1/2
7117/020	20 mm	1/2

GN-Systemmaße siehe Seite 34. Weitere Antihaf-
Konvektomatenbleche finden Sie auf Seite 36.
See page 34 for GN system sizes. See on page 36 for further
non-stick oven trays.



Antihaf- GN Konvektomatenblech
aus Edelstahl 18/10, Oberfläche mit schwarzer,
doppelter PTFE-Antihafbeschichtung, schwere Qualität

GN Combi Oven Trays, non-stick
18/10 stainless steel, double coated with PTFE,
heavy gauge



Art-Nr. Part No.	Tiefe Depth	GN
6511/020	20 mm	1/1
6521/020	20 mm	2/1

Weitere Größen auf Anfrage erhältlich.
GN-Systemmaße siehe Seite 34.
Further sizes on request.
See page 34 for GN system sizes.



Antihaf-GN-Konvektomatenblech
aus Edelstahl 18/10, Oberfläche mit PTFE-Beschichtung,
schwere Qualität

GN Combi Oven Trays, non-stick
18/10 stainless steel, coated with PTFE, heavy gauge



Edelstahlrahmen GN 1/1

aus Edelstahl 18/10, Außenmaß GN 1/1, geeignet für Gastronorm-Behälter bis Größe GN 1/1 in 40 mm Tiefe oder GN-Konvektomatenbleche, nach vorne geneigt, daher ideal zur Speisenpräsentation auf dem Buffet oder in der Theke

GN 1/1 Frame

18/10 stainless steel, suitable for 1/1 Gastronorm containers up to 40 mm deep, tilted for presentation



Art-Nr. Part No.	GN	Höhe Height cm
7029/011	1/1	4,5 - 10

Kann nicht mit dem Kühlsystem 6201 eingesetzt werden.
Gerade Rahmen siehe Serie 7030 auf Seite 304.
Not for use with 6201 cold buffet system.
For horizontal frames see part no. 7030 page 304.

GN 1/1 Abtropfblech

aus Edelstahl 18/10, zum Einhängen in GN 1/1 Behälter mit 200 mm Tiefe, Speisen - insbesondere Pommes frites - tropfen ab und lassen sich einfach mit einer Schaufel aufnehmen

GN 1/1 Chip Scuttle

18/10 stainless steel, for draining of e.g. French Fries in a GN 1/1 container of at least 200 mm depth



Art-Nr. Part No.	GN	Höhe Height cm
6071/011	1/1	13

Abgebildeter GN-Behälter 7011/200 bitte separat bestellen:
Please order the shown GN 1/1 container 7011/200 separately:
7011/200 1/1 20

GN-Rost

aus Edelstahl, elektrolytisch poliert, extra schwere Qualität

GN Grid/ Shelf

stainless steel, electro-polished, extra heavy gauge



Art-Nr. Part No.	GN	Ø Draht Ø Wire
7911/100	1/1	6 mm / 3 mm
7912/325	1/2	5 mm / 2,5 mm
7923/325	2/3	5 mm / 3 mm
7921/200	2/1	7 mm / 4 mm

GN-Systemmaße siehe Seite 34.
See page 34 for GN system sizes.

GN Grillrost für Hähnchen

aus Edelstahl, zur Verwendung in Öfen mit GN 1/1 Einschüben, passend für 8 Hähnchen, sehr stabile Ausführung

GN 1/1 Combination

Oven Chicken Roaster

stainless steel rack, takes 8 chickens, heavy gauge



Art-Nr. Part No.	GN	Höhe Height cm	Anzahl Fächer Slots
7629/008	1/1	16	8

Drahtkorb GN 1/1

ganz aus Edelstahl, passend in alle GN 1/1 Einschübe, Korb aus stabilem Drahtgeflecht, allseitig umlaufender Griff, zum Backen, Grillen, Auftauen und Trocknen von Speisen, gut geeignet für vorfrittierte Lebensmittel in Konvektomaten, schwere Qualität

GN 1/1 Combi Oven Wire Basket

stainless steel frame and mesh, for frying, heavy gauge



Art-Nr. Part No.	Länge außen Outer Length cm	Breite außen Outer Width cm	Höhe Height mm
7630/065	53	32,5	65

Art-Nr. Part No.	Länge Length m m	GN breit GN width ways	GN längs GN lengthways
7007/530	530	2/1	1/1
7007/325	325	1/1	1/2
7007/265	265	1/2	1/4
7007/176	176	1/3	1/6
7007/162	162	1/6	

Die Stegbreite beträgt 2 cm. GN-Systemmaße siehe Seite 34.
Die angegebenen GN-Maße beschreiben die GN-Behältergrößen auf die die Stege entweder breit- oder längsseits gelegt werden können.
The bars are 2 cm wide. See page 34 for GN System sizes.
The specified GN dimensions describe the GN container sizes on which the bars can be fitted either width or length ways.



GN-Zwischensteg

aus Edelstahl, wird benötigt, um kleinere Behälter im größeren Verbund einzuhängen

Separator Bars

stainless steel, needed to support small sized containers in a larger bain marie well



Art-Nr. Part No.	Länge Length m m	GN breit GN width ways	GN längs GN lengthways
7008/530	530	2/1	1/1
7008/325	325	1/1	1/2
7008/265	265	1/2	1/4
7008/176	176	1/3	1/6
7008/162	162	1/6	

Die Stegbreite beträgt 2 cm. GN-Systemmaße siehe Seite 34.
Die angegebenen GN-Maße beschreiben die GN-Behältergrößen auf die die Stege entweder breit- oder längsseits gelegt werden können.
The bars are 2 cm wide. See page 34 for GN System sizes.
The specified GN dimensions describe the GN container sizes on which the bars can be fitted either width or length ways.



GN-Zwischensteg

mit Klemmfeder gegen Verrutschen, aus Edelstahl 18/10, wird benötigt, um kleinere Behälter im größeren Verbund einzuhängen

Separator Bars

with spring clip, 18/10 stainless steel, needed to support small sized containers in a larger bain marie well



Art-Nr. Part No.	GN	Ø Draht Ø Wire
7009/016	1/1	8 mm

Passende GN 1/6 Behälter bitte separat bestellen, zum Beispiel den abgebildeten Behälter von Seite 35: / Please order matching GN 1/6 container separately e.g. the container shown here from page 35:
7016/065 1/6



GN 1/1 Systemteiler

aus Edelstahl 18/0, passend für GN 1/6 Behälter jeder Tiefe, die sonst nicht in GN 1/1 Einschübe passen würden. Durch die zwei beweglichen Griffe können die Behälter auch praktisch transportiert und abgesetzt werden.

GN 1/1 System Divider

18/0 stainless steel, takes GN 1/6 containers of any depth which would otherwise not fit into GN 1/1 racks, 2 adjustable handles make transport and lifting easy



Art-Nr. Part No.	GN	Höhe Height m m	Anzahl Fächer Slots	Portionsgröße Portion size cm
7052/018	1/1	65	18	8 x 10

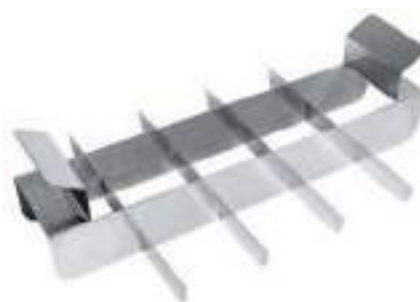

Schneidgitter GN

aus Edelstahl 18/10, 65 mm Schnittiefe, zum Schneiden von gleichgroßen Portionen in GN Behältern, z.B. Backware, Pizza, Gratin u.a.

GN 1/1 65 mm Portioner

18/10 stainless steel, for portioning pizzas, pastry, cakes etc.



GN Ablagegestell

aus Edelstahl, für sieben Deckel GN 1/1, 1/2, 1/3 sowie maximal 3,5 cm starken Schneidbrettern, Tablets u.a., zum Einschieben in GN 1/1-Regalwagen, auch als Tischgestell einsetzbar, spülmaschinengeeignet, schwere Qualität



Art-Nr. Part No.	Länge Length cm	Breite Width cm	Höhe Height cm
7544/007	50,6	32,5	24,5

GN Lids Rack

stainless steel wire, for seven e.g. 1/1, 1/2, 1/3 GN lids or max. 3.5 cm thick cutting boards, trays etc., fits into GN 1/1 trolleys, can be used on work surface, dishwasher safe, lids not included, heavy gauge



Kasten für GN-Behälter

aus Edelstahl, allseitig geschlossen, Boden offen, für maximal drei 1/3 oder sechs 1/6 GN Behälter mit maximal 150 mm Tiefe



GN Counter Top Prep Unit

stainless steel, solid walls, open base, for max. three 1/3 or six 1/6 GN containers with a maximum depth of 150 mm supplied without GN-containers



Art-Nr. Part No.	Länge Length cm	Breite Width cm	Höhe Height cm
7571/980	98	25	21

Lieferung ohne abgebildete GN-Behälter.
Supplied without GN containers.

Gestell GN 1/1

aus Edelstahl, für Buffet und Küche, verschweißtes 25 x 25 mm Vierkantrohr, leicht geneigt, das mitgelieferte Befestigungsset ermöglicht auch eine Wandmontage, für GN-Einsätze aus allen Materialien, Besteckmulden, Körbe u.a.



GN 1/1 Counter Top Prep Unit

stainless steel, 25 x 25 mm rod, supplied with wall mounting option, for GN pans, cutlery boxes, baskets etc.



Art-Nr. Part No.	Länge Length cm	Breite Width cm	Höhe Height cm
7556/530	56	37	23,5

Für den Einsatz eines Besteckkastens Art. 56/550 empfehlen wir den Zwischensteg Art. 7007/530 als Abstandhalter.

Lieferung ohne abgebildete GN-Behälter.
For the use of a cutlery box as Art. 56/550 we recommend using a separator bar Art. 7007/530 to fill the gap.
Supplied without shown GN containers.

Wandboard für GN-Behälter 1/6

aus Edelstahl, für maximal 6 Stück GN 1/6

Wall Fitting Prep Unit

stainless steel, for maximum 6 x GN 1/6 container



Art-Nr. Part No.	Länge Length cm	Breite Width cm	Höhe Height cm	Anzahl Fächer Slots
7561/120	120	20	20	6

Lieferung ohne die abgebildeten GN-Behälter.
Supplied without GN containers.







GastroNorm Polypropylen

Diese Behälter sind eine kostengünstige Option für Lagerung und Transport. Die dicht schließenden Deckel sorgen für lang anhaltende Frische.

Polypropylene Gastronorm

These containers are a cost-effective option for food storage and transportation. The tightly closing lids ensure optimum freshness.

- | | | | | | |
|---|--|--|--|---|---|
|  POLYPROPYLEN |  SPÜLMASCHINE
DISHWASHER |  GN |  STAPELBAR
STACKABLE |  MICROWELLE
MICROWAVE |  KÜHLBAR
COOLABLE |
|---|--|--|--|---|---|
- Klemmdeckel
 - mikrowellentauglich
 - spülmaschinengeeignet
 - tiefgefriergeeignet
 - tightly fitting lids
 - suitable in microwave ovens
 - dishwasher safe
 - freezer safe

Polypropylen ist ein hart elastischer milchig-transparenter Kunststoff, der in einem Temperaturbereich von -40°C bis +80°C einsetzbar ist. Er ist sehr hygienisch, geschmacks- und geruchsneutral. Bitte beachten Sie dass die Außenmaße der Behälter ggf. materialbedingt außerhalb der EN-631 Normtoleranzen liegen können.

Polypropylene is a tough but flexible translucent plastic material which can be used in temperatures from -40°C up to +80°C. It is very hygienic and the taste and smell of food are unaffected. Due to the nature of the material, the outer dimensions of the containers do not match the EN-631 standards exactly.

Art-Nr. Part No.	Tiefe Depth mm		GN
5511/065	65	8,5 l	1/1
5511/100	100	13,5 l	1/1
5511/150	150	20 l	1/1
5511/200	200	27,5 l	1/1
5512/065	65	3,5 l	1/2
5512/100	100	6 l	1/2
5512/150	150	9 l	1/2
5512/200	200	12 l	1/2
5513/065	65	2 l	1/3
5513/100	100	3,5 l	1/3
5513/150	150	5,5 l	1/3
5513/200	200	7 l	1/3
5514/065	65	1,5 l	1/4
5514/100	100	2,5 l	1/4
5514/150	150	4 l	1/4
5514/200	200	4,5 l	1/4
5516/065	65	0,8 l	1/6
5516/100	100	1,5 l	1/6
5516/150	150	2 l	1/6
5516/200	200	2,5 l	1/6
5519/065	65	0,5 l	1/9
5519/100	100	1 l	1/9

Art-Nr. Part No.	GN
5511/532	1/1
5512/325	1/2
5513/325	1/3
5514/265	1/4
5516/176	1/6
5519/176	1/9



GN-Behälter Polypropylen

robuste Profiqualität.
Klemmdeckel bitte separat bestellen.

GN Polypropylene Container

heavy gauge.
Please order lids separately.

GN-Deckel Polypropylen

passend auf unsere GN Behälter aus Polypropylen

GN Polypropylene Lids

matches all sizes of our 5500 range of polypropylene GN containers

Markierclips

aus Polypropylen, zur farbigen Markierung von GN-Deckeln der Serie 5511

Colour Coded Clips

polypropylene, for colour coding 5511 GN lids



Art-Nr. Part No.	Farbe Colour
5527/002	gelb/yellow
5527/003	blau/blue
5527/006	grün/green
5527/008	violett/purple
5527/009	rot/red

GN Deckel, farbig

aus Polypropylen, in HACCP-Farben zur Codierung des Füllinhalts, mikrowellentauglich, tiefkühl- und spülmaschinengeeignet, geschmacksneutral, passend auf unsere GN Behälter 5511 aus Polypropylen

Colour Coded GN Lids

polypropylene, suitable for use in microwave ovens, freezer and dishwasher safe, matches all sizes of our 5511 range of polypropylene GN containers



Art-Nr. Part No.	GN	Farbe Colour
5525/112	1/1	gelb/yellow
5525/113	1/1	blau/blue
5525/116	1/1	grün/green
5525/118	1/1	violett/purple
5525/119	1/1	rot/red
5525/122	1/2	gelb/yellow
5525/123	1/2	blau/blue
5525/126	1/2	grün/green
5525/128	1/2	violett/purple
5525/129	1/2	rot/red
5525/132	1/3	gelb/yellow
5525/133	1/3	blau/blue
5525/136	1/3	grün/green
5525/138	1/3	violett/purple
5525/139	1/3	rot/red
5525/142	1/4	gelb/yellow
5525/143	1/4	blau/blue
5525/146	1/4	grün/green
5525/148	1/4	violett/purple
5525/149	1/4	rot/red
5525/162	1/6	gelb/yellow
5525/163	1/6	blau/blue
5525/166	1/6	grün/green
5525/168	1/6	violett/purple
5525/169	1/6	rot/red
5525/192	1/9	gelb/yellow
5525/193	1/9	blau/blue
5525/196	1/9	grün/green
5525/198	1/9	violett/purple
5525/199	1/9	rot/red

GN Behälter, allergen

mit Deckel, aus violettfarbenem Polypropylen, zur Aufbewahrung allergener Lebensmittel, temperaturbeständig von -40°C bis +95°C, mit Permanentbeschriftungsetikett

Allergen GN Container

with airtight lid, purple coloured polypropylene, for free from allergens food, withstands temperatures from -40°C up to +95°C, with permanent labelling



Art-Nr. Part No.	Tiefe Depth mm	GN
5542/150	150	10 l 1/2
5543/150	150	6 l 1/3
5544/150	150	4,3 l 1/4
5546/150	150	2,6 l 1/6

Art-Nr. Part No.	Tiefe Depth mm	GN	GN
5011/065	65	8 l	1/1
5011/100	100	13,5 l	1/1
5011/150	150	21 l	1/1
5011/200	200	28 l	1/1
5012/065	65	4 l	1/2
5012/100	100	6,5 l	1/2
5012/150	150	10 l	1/2
5012/200	200	12,5 l	1/2
5013/065	65	2,5 l	1/3
5013/100	100	4 l	1/3
5013/150	150	6 l	1/3
5014/065	65	1,8 l	1/4
5014/100	100	2,8 l	1/4
5014/150	150	4,3 l	1/4
5016/065	65	1,1 l	1/6
5016/100	100	1,7 l	1/6
5016/150	150	2,6 l	1/6
5019/065	65	0,6 l	1/9
5019/100	100	1 l	1/9
5019/150	150	1,5 l	1/9

Lieferung mit einem Satz farbig sortierter Clips zu jedem Behälter.
A set of coloured clips is supplied with each container.



GN Lebensmittelbehälter

aus transparent-weißem Polypropylen, mit Deckel aus Polyethylen, mit farbigen Clips zur Codierung des gelagerten Inhalts, temperaturbeständig von -40°C bis +95°C, spülmaschineneeignet, stapelbar

Gastronorm Food Container

translucent polypropylene, with polyethylene lid, with coloured clips for coding contents, withstands temperatures from -40°C to +95°C, stackable, dishwasher safe



Art-Nr. Part No.	GN	Tiefe Depth mm	GN
4911/020	1/1	20	1,4 l
4911/040	1/1	40	4,4 l
4911/065	1/1	65	7 l
4912/020	1/2	20	0,6 l
4912/040	1/2	40	1,8 l
4912/065	1/2	65	3,6 l
4913/065	1/3	65	2 l
4914/065	1/4	65	1,4 l
4916/065	1/6	65	0,8 l

Eine Verwendung von Melaminartikeln in Mikrowellen, Chafing Dishes, Bain-Maries, Öfen, auf oder unter Wärmequellen wird nicht empfohlen.

We do not recommend use in microwaves, chafing dishes, bain-maries, ovens, on hot plates or under heat lamps.



GN-Behälter aus Melamin

aus porzellanweißem Melamin

GN Container

white melamine



Art-Nr. Part No.	GN	Länge Length cm	Breite Width cm	Höhe Height cm
4931/011	1/1	53	32,5	2,5
4931/012	1/2	32,5	26,5	2,5

Eine Verwendung von Melaminartikeln in Mikrowellen, Chafing Dishes, Bain-Maries, Öfen, auf oder unter Wärmequellen wird nicht empfohlen.

We do not recommend use in microwaves, chafing dishes, bain-maries, ovens and on hot plates or under heat lamps.



Tablett GN Melamin

mit breitem Rand, aus porzellanweißem Melamin

GN Tray

with wide rim, white melamine



GastroNorm Polycarbonat

Mit diesen GN-Behältern haben Sie sofort alles im Blick und erleichtern somit Ihre Arbeit. In den bruchsicheren und robusten Behältnissen bleiben Ihre Lebensmittel länger frisch und aromatisch.

Polycarbonate Gastronorm

With these GN containers you can see everything at a glance, making your work easier. The shatter-proof robust containers keep your food fresh and aromatic for longer.

Polycarbonat ist ein starrer und durchsichtiger Kunststoff, der in einem Temperaturbereich von -40°C bis +100°C einsetzbar ist. Er ist sehr hygienisch, geschmacks- und geruchsneutral. Die Skalierung im Inneren des Behälters ermöglicht eine genaue Befüllung. Durch schwappsichere Deckel wird ein Überlaufen während des Transports verhindert. Nicht kratzsicher, daher keine scheuernden Reinigungsmittel verwenden.

Polycarbonate has a temperature resistance from -40°C up to +100°C. It complies fully with food hygiene requirements. Ideal for commercial food processing and handling facilities. Accurate portion control graduation inside the containers. Tight fitting lids prevent liquids spilling during transportation. Do not use steel wool or anything abrasive for cleaning.



- durchsichtig
- schwappsicherer Deckel
- spülmaschinengeeignet
- tiefgefriergeeignet
- nicht mikrowellengeeignet
- clear
- tight fitting lids
- dishwasher safe
- suitable for freezers
- not suitable for microwaves

GN Behälter Polycarbonat

klar transparent, stapelbar, spülmaschinengeeignet, einsetzbar von -40°C bis +110°C

GN Polycarbonate Containers

clear, stackable, dishwasher safe, temperature resistant from -40°C to +110°C



Art-Nr. Part No.	Tiefe Depth mm		GN
8211/065	65	8,5 l	1/1
8211/100	100	13,5 l	1/1
8211/150	150	20 l	1/1
8211/200	200	27,5 l	1/1
8212/065	65	3,5 l	1/2
8212/100	100	6 l	1/2
8212/150	150	9 l	1/2
8212/200	200	12 l	1/2
8213/065	65	2 l	1/3
8213/100	100	3,5 l	1/3
8213/150	150	5,5 l	1/3
8213/200	200	7 l	1/3
8214/065	65	1,5 l	1/4
8214/100	100	2,5 l	1/4
8214/150	150	4 l	1/4
8214/200	200	6 l	1/4
8216/065	65	0,8 l	1/6
8216/100	100	1,5 l	1/6
8216/150	150	2 l	1/6
8216/200	200	3,4 l	1/6
8219/065	65	0,5 l	1/9
8219/100	100	1 l	1/9
8221/200	200	40 l	2/1
8224/065	65	3,3 l	2/4
8224/100	100	4,5 l	2/4

Art-Nr. Part No.	Tiefe Depth mm		GN
3811/065	65	8,3 l	1/1
3811/100	100	13 l	1/1
3811/150	150	19,5 l	1/1
3812/065	65	3,96 l	1/2
3812/100	100	6,15 l	1/2
3812/150	150	9,16 l	1/2
3813/065	65	2,71 l	1/3
3813/100	100	4,1 l	1/3
3813/150	150	5,43 l	1/3
3814/065	65	1,73 l	1/4
3814/100	100	2,89 l	1/4
3814/150	150	3,72 l	1/4
3816/065	65	0,85 l	1/6
3816/100	100	1,56 l	1/6
3816/150	150	2,25 l	1/6
3819/100	100	1,06 l	1/9

Passende transparente Deckel siehe Serie 8211 oder 8311.
For matching clear lids see 8211 or 8311 range.



GN Polycarbonat, schwarz

außen graduiert, stapelbar, spülmaschineneeignet, einsetzbar von -40°C bis +110°C

Black Polycarbonate GN Containers

graduated outside, stackable, food and dishwasher safe, temperature resistant from -40°C to +110°C

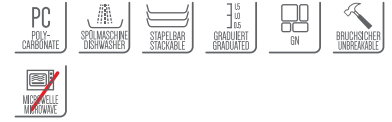

Art-Nr. Part No.	GN
8211/530	1/1
8212/325	1/2
8213/325	1/3
8214/265	1/4
8216/176	1/6
8219/176	1/9
8221/650	2/1
8224/530	2/4

Sie finden passende Deckel aus Polycarbonat für unsere Edelstahlbehälter auf Seite 37.

See page 37 for polycarbonate lids that match our stainless steel Gastronorm containers.



GN-Auflagedeckel

aus Polycarbonat, mit Griffmulden, passend auf Polycarbonat-GN-Behälter Serie 8200, aber auch auf Polypropylen-GN-Behältern Serie 5500 (ausgenommen GN 1/9)

GN Lid

polycarbonate, for 8200 range, matches all sizes of our 5500 range of polypropylene GN containers except the 1/9 size



Art-Nr. Part No.	GN
8311/530	1/1
8312/325	1/2
8313/325	1/3
8314/265	1/4
8316/176	1/6
8319/176	1/9



GN-Klemmdeckel

aus Polycarbonat, bedingt dichtschießender Deckel, stapelbar, ausschließlich für GN-Polycarbonat-Behälter Serie 8200 geeignet

GN Lid

polycarbonate, tight fitting lid, stackable, exclusively for the range of GN Polycarbonate 8200 containers



Art-Nr. Part No.	für GN for GN	Höhe Height cm	Länge Length cm	Breite Width cm
8002/011	1/1	1,5	46,5	26,5
8002/012	1/2	1,5	26,5	20,5
8002/013	1/3	1,5	26,5	11,5
8002/014	1/4	2	20,5	10
8002/016	1/6	1,5	11,5	10
8002/021	2/1	1,5	56,5	45

Diese Einlegeböden passen GN-Behälter aus Polycarbonat der Größen 1/1, 1/2 und 1/3, sowie anderer Größen bis 150 mm Tiefe. Kombinationen mit anderen GN-Behältern siehe auf contacto.de.

These shelves fit polycarbonate GN containers of sizes 1/1, 1/2 and 1/3, as well as other sizes up to 150 mm deep. For combinations with other GN containers, see contacto.de.



GN-Einlegeboden

aus Polycarbonat, transparent, stapelbar

GN Trivet/ Drainer Plate

clear polycarbonate, stackable



Schale, rechteckig

aus Edelstahl 18/10, matt poliert, mit abgerundeten Kanten, mit offen gebördeltem Rand, absolut planer Boden, sehr schwere Qualität

Baking Dish

18/10 stainless steel, matt polished finish, open rolled edge, very heavy gauge, very flat base



Art-Nr. Part No.	Länge innen Inner Length cm	Breite innen Inner Width cm	Höhe Height cm	
7755/350	35	25	5	4 l
7755/450	45	30	5	6 l
7755/550	55	35	5	8 l
7755/650	65	40	5	11 l

18/10
EDELSTAHL
STAINLESS STEEL

Schale, rechteckig

aus Edelstahl 18/10, seidenmatt poliert, glatt auslaufender Rand, großer Eckradius, vielseitig als Fleischbecken oder Auflaufform verwendbar

Roasting Dish

18/10 stainless steel, satin polished, with open, flat edge and rounded corners



Art-Nr. Part No.	Länge außen Outer Length cm	Breite außen Outer Width cm	Höhe Height cm	
5400/190	19	12	4	0,6 l
5400/240	24	17	4	1,2 l
5400/300	30	20,5	6	2 l

18/10
EDELSTAHL
STAINLESS STEEL

Schale, rechteckig

aus Edelstahl 18/10, seidenmatt poliert, glatt auslaufender Rand - an den kurzen Seiten breiter als Grifffläche nutzbar

Roasting Dish

18/10 stainless steel, satin polished, flat edge, with extra rounded base



Art-Nr. Part No.	Länge außen Outer Length cm	Breite außen Outer Width cm	Höhe Height cm	
5405/240	24	16	4,5	1 l
5405/300	31	20	4,5	1,5 l
5405/340	34	21	6	3 l
5405/360	37,5	27	5	3,3 l

18/10
EDELSTAHL
STAINLESS STEEL

Schale, rechteckig

aus Edelstahl 18/10, seidenmatt poliert, steile Wandung, mit schmalem, glatt auslaufendem Rand, schwere Qualität

Roasting Dish

18/10 stainless steel, steep wall satin polished



Art-Nr. Part No.	Länge außen Outer Length cm	Breite außen Outer Width cm	Höhe Height cm	
274/315	31,5	21,5	6	3 l

18/10
EDELSTAHL
STAINLESS STEEL

Schale, oval

aus Edelstahl, matt poliert, mit hochglänzendem breiten Rand

Oval Dish

stainless steel, matt polished finish, wide mirror polished rim



Art-Nr. Part No.	Länge Length cm	Breite Width cm	Höhe Height cm	
7067/001	51,5	31,5	6,5	5 l

INOX
EDELSTAHL
STAINLESS STEEL

Art-Nr. Part No.	Länge außen Outer Length cm	Breite außen Outer Width cm	Höhe Height cm
7744/350	35	24	5,5
7744/500	50	35	5,5



Grill-/ Abtropfschale

aus Edelstahl 18/10, hochglänzend, mit offenem gebördelten Rand, mit gelochtem Einsatz mit 10 mm-Lochung, ideal auch als Abtauplatte für Gefriergut, schwere Qualität

Roasting Pan

18/10 stainless steel, mirror polished finish, with open rolled edge, with drainer plate with 10 mm perforations, heavy gauge



Art-Nr. Part No.	Länge Length cm	Breite Width cm	Höhe Height cm	
4907/200	30	20,5	6	2 l
4907/300	34,5	23,5	7,5	3 l
4907/800	48,5	33,5	8	8 l



Schale, rechteckig

aus weißem Polyethylen, einsetzbar von -40°C bis +90°C, stapelbar, abgerundete Kanten zur leichten Reinigung

Food Storage Container

white polyethylene, withstands temperatures from -40°C to +90°C, stackable, rounded edges for easy cleaning



Art-Nr. Part No.	Länge Length cm	Breite Width cm	Höhe Height cm
5406/260	26	18	2,5



Auslagentablett

aus Edelstahl 18/10, matt poliert, mit abgerundeten Ecken

Display/Butcher's Tray

18/10 stainless steel, satin polished, rounded corners



Art-Nr. Part No.	Länge außen Outer Length cm	Breite außen Outer Width cm	Höhe Height cm	
5407/250	26	20	4,5	1,8 l
5407/300	31	24,5	5	3 l
5407/350	36	27,5	5	4 l



Auslageschale

aus Edelstahl 18/10, hochglänzend, mit umgelegtem, schmalen Rand

Display Dish

18/10 stainless steel, mirror polished, with open rolled edge



Art-Nr. Part No.	Länge Length cm	Breite Width cm	Höhe Height cm	
5430/150	15	10	3	0,25 l



Sülzkotelettform

aus Edelstahl 18/10, mit glatt auslaufendem Rand, schwere Qualität

Aspic Cutlet Mould

18/10 stainless steel, heavy gauge



GastroNorm Kombinationsmöglichkeiten

Ausgehend von der Größe GN 1/1 bietet sich eine große Anzahl von Kombinationsmöglichkeiten aus den verschiedenen Teilungen. Gestalten Sie Ihren Arbeitsplatz oder Ihre Thekenauslage nach den individuellen Anforderungen.

Gastronorm Combinations

Based on the GN 1/1 full size, there are a huge number of possible combinations. Design your workplace or your counter display according to your individual requirements.

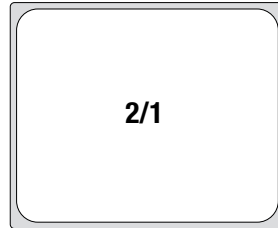

Referenzgröße
Full Size



Die Kombinationsmöglichkeiten mit gerader Teilung (1/2, 1/4, 2/4, 2/8) und universeller Teilung (1/12, 2/24)

Possible combinations with even divisions (1/2, 1/4, 2/4, 2/8) and universal divisions (1/12, 2/24)

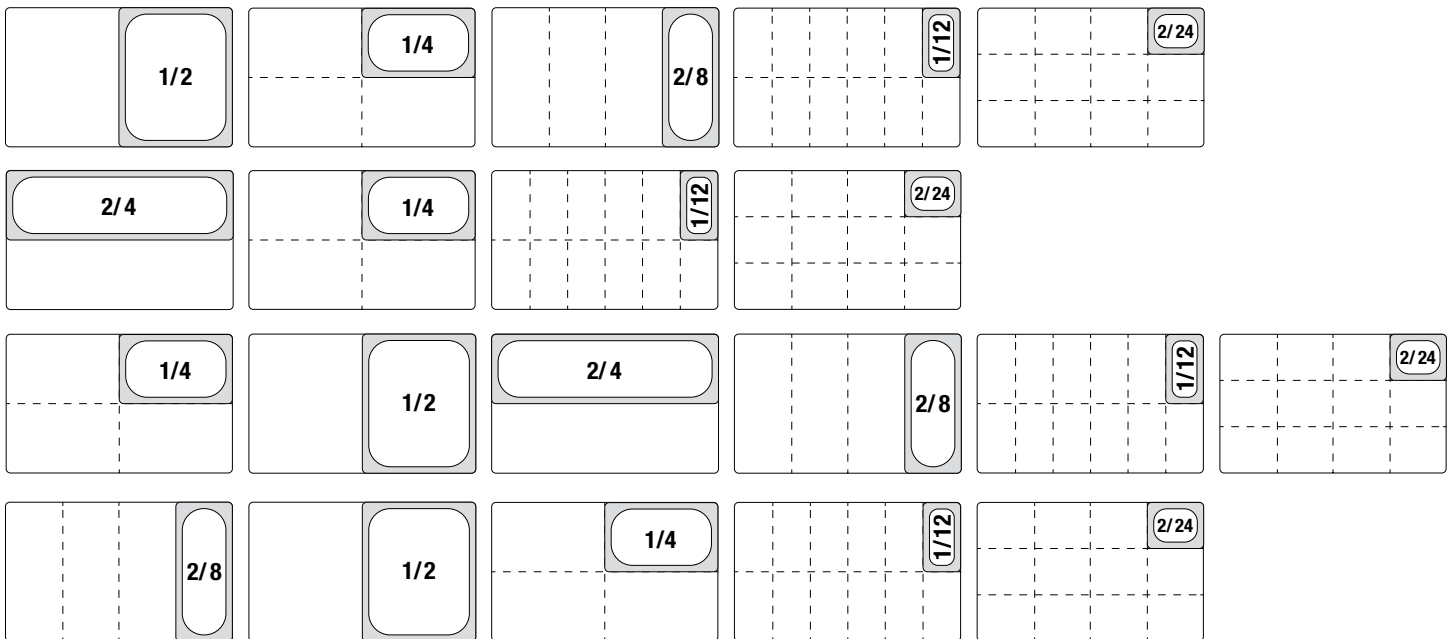

Die Kombinationsmöglichkeiten mit ungerader Teilung (1/3, 2/3, 1/6, 1/9)

Possible combinations with odd divisions (1/3, 2/3, 1/6, 1/9)

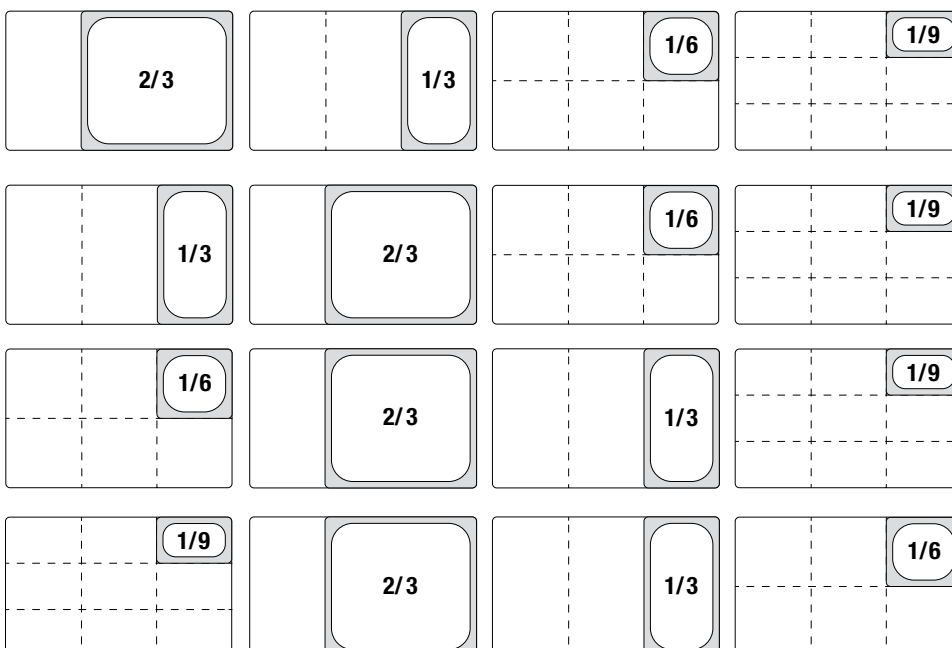

GastroNorm Höhen: Gastronorm height:

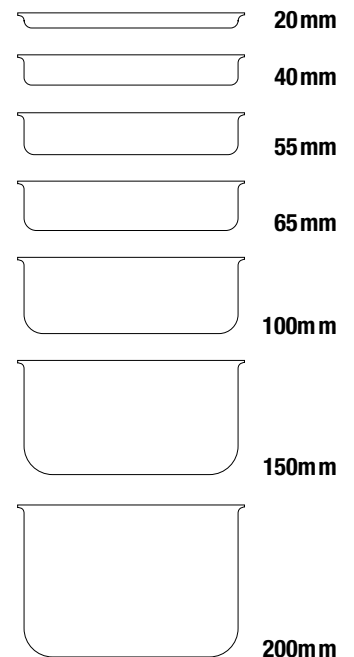

Aufbewahrung

Dosen, Kästen, Schalen, Gläser, Körbe – um Lebensmittel aufzubewahren, einzukochen, einzufrieren oder aufzutauen gibt es so viele Möglichkeiten. In dieser Kategorie finden Sie die passenden Behältnisse um Speisen und Zutaten hygienisch zu lagern und länger frisch zu halten.

Food & Drink Handling

Containers, buckets, bowls, strainers, funnels, dispensers...there are so many ways to store, measure, strain or move food and drink. In this category you will find the right containers to keep food and ingredients fresh for longer and to store them correctly.

Seite Page
54



Transportkannen & Eimer
Multipurpose Containers & Buckets

Seite Page
62



Aufbewahrungsbehälter
Storage Containers

Seite Page
70



Dispenser
Sauce Dispensers

Seite Page
76



Schüsseln, Seiher & Siebe
Bowls, Basins & Sieves

Seite Page
80



Salatschleudern
Salad Spinner

Seite Page
88



Abfüllhilfen & Streuer
Scoops, Measures & Funnels

Transportkannen & Eimer

Die Transportbehälter aus 18/10 Edelstahl zeichnen sich durch ihre robuste Langlebigkeit aus. Sie sind absolut hygienisch, industrietauglich und sind leicht zu reinigen.

Multipurpose Containers & Buckets

These 18/10 stainless steel containers are characterised by their outstanding quality and robust durability. They are absolutely hygienic, suitable for industrial use and easy to clean.

Universalbehälter

aus hochwertigem Edelstahl 18/10 hergestellt, konstante Materialstärke, hochglänzend, mit Bodenreifen, extra schwere Qualität

Multipurpose Container

18/10 stainless steel, mirror polished finish, with reinforced base, superb quality, extra heavy gauge



Art-Nr. Part No.	∅ dia. cm	Höhe Height cm	Stärke Thickness mm	
3008/020	26,5	39,5	1,0	20 l
3008/025	30	39,5	1,0	25 l
3008/030	30	46,5	1,0	30 l

Ab /050 mit Griffverstärkungsplatten:

From /050 equipped with reinforced handles:

3008/050	35	55,5	1,0	50 l
3008/075	40	62	1,0	75 l
3008/100*	44,5	67	1,1	100 l
3008/150*	55	67	1,2	150 l

*Versand dieser Größen nur per Spedition möglich.

*For these sizes pallet delivery only.

Rolluntersatz hierzu siehe Seite 489. Ablasshahn auf Anfrage.

For matching castors see page 489. Tap available on request.

Deckel

für Behälter 3008, aus Edelstahl 18/10, hochglänzend

Lid for 3008

18/10 stainless steel, mirror polished finish



Art-Nr. Part No.	passend zu Matches
3088/020	3008/020
3088/025	3008/025
3088/030	3008/030
3088/050	3008/050
3088/075	3008/075
3088/100	3008/100
3088/150	3008/150

Universalbehälter

aus Edelstahl 18/10, extra schwere Qualität, Ausführung entspricht Behälter 3008, jedoch komplett mit Deckel und drei Spannverschlüssen zur Sicherung

Multipurpose Container

18/10 stainless steel, extra heavy gauge, as model 3008 but includes lid and 3 latches



Art-Nr. Part No.	∅ dia. cm	Höhe Height cm	Stärke Thickness mm	
3007/020	26,5	39,5	1,0	20 l
3007/025	30	39,5	1,0	25 l
3007/030	30	46,5	1,0	30 l

Ab /050 mit Griffverstärkungsplatten: / From /050 equipped with reinforced handle:

3007/050	35	55,5	1,0	50 l
3007/075	40	62	1,0	75 l
3007/100*	44,5	67	1,1	100 l
3007/150*	55	67	1,2	150 l

*Versand dieser Größen nur per Spedition möglich.

*For these sizes pallet delivery only.

Nitril-Dichtungsring auf Anfrage lieferbar.

Rolluntersatz hierzu siehe Seite 489.

Rubber seal on request. For matching castors see page 489.



Art-Nr. Part No.	∅ dia. cm	Höhe Height cm	Stärke Thickness mm	
3031/000	8	10	0,8	0,5 l
3031/001	10	15	1,0	1 l
3031/002	13,5	18,5	1,0	2 l
3031/003	15	21	1,0	3 l
3031/005	17,5	25,5	1,0	5 l



Transportkanne

aus Edelstahl 18/10, mit Tragebügel, ohne Bodenring, mit Deckel, extra schwere Qualität

Churn with Lid

18/10 stainless steel, with handle and lid, extra heavy gauge



Art-Nr. Part No.	∅ dia. cm	Höhe Height cm	Stärke Thickness mm	∅ oben ∅ Top cm
3010/025	32	41,5	1,0	25 l 22
3010/030	32	48	1,0	30 l 22
3010/040*	35,5	55,5	1,0	40 l 23,5
3010/050*	35,5	65	1,0	50 l 23,5

* Deckel standardmäßig mit Kette ausgestattet
* Lid supplied with chain



Transportkanne

aus Edelstahl 18/10, seidenmatt glänzend, mit Bodenring und Deckel, extra schwere Qualität

Churn with Lid

18/10 stainless steel, satin polished finish, with lid and reinforced base, extra heavy gauge



Art-Nr. Part No.	∅ dia. cm	Höhe Height cm	Stärke Thickness mm	
3032/010	22,5	33,5	0,9	10 l
3032/015	27	36,5	1,0	15 l
3032/020	27	42	1,0	20 l



Transportkanne

aus Edelstahl 18/10, hochglänzend, mit Tragebügel und Bodenring, mit Deckel, extra schwere Qualität

Churn with Lid

18/10 stainless steel, mirror polished finish, with handle and lid and reinforced base, extra heavy gauge



Art-Nr. Part No.	∅ dia. cm	Höhe Height cm	Stärke Thickness mm	
3033/005	17,5	27	0,9	5 l
3033/010	22	35	0,9	10 l
3033/020	27	42,5	1,0	20 l



Transportkanne

aus Edelstahl 18/10, seidenmatt glänzend, mit Deckel, Ausgusschnaupe, Bodenring, Tragebügel und Griff, extra schwere Qualität

Churn with Lid

18/10 stainless steel, satin polished finish, with spout, reinforced base, handle and lid, extra heavy gauge



Eimer, zylindrisch

aus Edelstahl 18/10, seidenmatt glänzend, mit Deckel, extra schwere Qualität

Food/Drinks Carriers

18/10 stainless steel, satin polished finish, with lid, extra heavy gauge



Art-Nr. Part No.	∅ dia. cm	Höhe Height cm	Stärke Thickness mm
---------------------	-----------------	----------------------	---------------------------

Ohne Bodenreifen: / Without base ring:

3003/002	13	17	0,8	2 l
3003/003	15,5	18	0,8	3 l
3003/805*	17,5	22	0,8	5 l

Mit Bodenreifen: / With base ring:

3003/005	17,5	24	0,8	5 l
3003/008	20	29	0,8	8 l
3003/010	22	30	0,8	10 l

* tiefgezogen

* deep drawn

Eimer, zylindrisch

aus Edelstahl 18/10, seidenmatt glänzend, extra schwere Qualität

Food/Drinks Carriers

18/10 stainless steel, satin polished finish, extra heavy gauge



Art-Nr. Part No.	∅ dia. cm	Höhe Height cm	Stärke Thickness mm	
3005/010	24	25	0,8	10 l
3005/012	24	28,5	0,8	12 l
3005/015	27	29	0,8	15 l

Deckel bitte separat bestellen (Art. 3006).

Please order lid separately (Part No.3006)

Messeimer, zylindrisch

aus Edelstahl 18/10, seidenmatt glänzend, literweise graduert, mit Henkelgriff und Ausgusschnaupe, extra schwere Qualität

Graduated Food/Drinks Carrier with Spout

18/10 stainless steel, satin polished finish, graduated in litres, with handle and spout, extra heavy gauge



Art-Nr. Part No.	∅ dia. cm	Höhe Height cm	Stärke Thickness mm	
3100/010	24	28	0,8	10 l
3100/015	27	31	0,8	15 l
3100/020	27	40	0,8	20 l

Deckel bitte separat bestellen (Art. 3006).

Please order lid separately (Part No. 3006)

Deckel

für Eimer 3100 und 3005 aus Edelstahl 18/10, seidenmatt glänzend, extra schwere Qualität

Lid

for 3100 and 3005, 18/10 stainless steel, satin polished finish



Art-Nr. Part No.	passend zu Matches
3006/010	/010
3006/012	/012
3006/015	/015 und /020

Transporteimer

aus Edelstahl 18/10, hochglänzend, mit Deckel, Dichtungsring aus Silikon, mit drei Spannverschlüssen, eventueller Über-/Unterdruck lässt sich durch Ventil im Deckel aufheben, schwere Qualität

Food/Drinks Carriers

18/10 stainless steel, mirror polished finish, lid with silicone gasket and three latches, vented, heavy gauge



Art-Nr. Part No.	∅ innen ∅ Inside cm	Höhe Height cm	
3011/007	6,5 l	24	16
3011/010	10,5 l	24	25
3011/015	15,5 l	30	23



Art-Nr. Part No.	∅ dia. cm	Höhe Height cm	Stärke Thickness mm	
3080/003	15,5	20,5	1,0	3 l
3080/005	17,5	27	1,0	5 l
3080/010	22	32,5	1,0	10 l

Dichtschließende Ausführung mit Dichtungsring und Spannverschlüssen als Sonderbestellung möglich.
Watertight version with gasket and clamps on request.



Transportbehälter, isoliert

aus Edelstahl 18/10, doppelwandig, seidenmatt glänzend, mit Tragebügel und Deckel, stapelbar, extra schwere Qualität

Insulated Food/Drinks Carrier

18/10 stainless steel, satin polished finish, with handle and lid, stackable, extra heavy gauge



Art-Nr. Part No.	∅ dia. cm	Höhe außen Outer Height cm	Stärke Thickness mm	
3081/010	34	20	0,8	10 l
3081/020	34	33	0,8	20 l
3081/030*	34	51	0,8	30 l

* Einsätze auf Anfrage erhältlich
* Inserts available on request



Transportbehälter, isoliert

aus Edelstahl 18/10, doppelwandig, seidenmatt gebürstet, mit Tragebügel, ohne Kompensboden, Deckel mit Silikondichtung und mit drei Spannverschlüssen, Überdruckventil, schwere Qualität

Double Walled Food Carrier

18/10 stainless steel, satin polished finish, double walled, with handle, tight fitting lid with silicone gasket and three latches, heavy gauge



Art-Nr. Part No.	∅ dia. cm	Höhe Height cm	
3086/010	32	20	10 l



Transportbehälter, isoliert

mit Gummischutzring, aus Edelstahl 18/10, doppelwandig, seidenmatt gebürstet, mit zwei Fallgriffen, ohne Kompensboden, Deckel mit Silikon-dichtung und mit sechs Spannverschlüssen, Überdruck kann durch Ventil entweichen, schwere Qualität

Insulated Food Carrier

with protective rubber foot, 18/10 stainless steel, satin polished finish, double walled, with handles, tight fitting lid with silicone gasket and six latches, heavy gauge



Art-Nr. Part No.	∅ dia. cm	Höhe gesamt Overall Height cm	
3083/010	32	30,5	10 l
3083/020	32	44,5	20 l



Getränkebehälter, isoliert

aus Edelstahl 18/10, hochglänzend, doppelwandig, mit Tragebügel und 11 cm hohem Bodenring, mit 3/8" No-Drip-Hahn, Deckel mit Silikondichtung, mit drei Spannverschlüssen, Überdruck kann durch Ventil entweichen, schwere Qualität

Insulated Urn

18/10 stainless steel, mirror polished finish, double walled, with handle and 11 cm foot, with 3/8" non drip tap, lid with silicone gasket and three latches



Eimer ohne Bodenreifen

aus Edelstahl 18/10, seidenmatt poliert, konische Form, einseitig graduert in 1-Liter Schritten, mit fugenlosen Henkellaschen

Bucket

18/10 stainless steel, satin polished finish, conical, graduated in litres inside



Art-Nr. Part No.		∅ dia. cm	Höhe Height cm
415/007*	7 l	25,5	24
415/010	10 l	30	25
415/012	12 l	31	27
415/015	15 l	32,5	31
* nicht graduert * not graduated			

Eimer mit verstärktem Bodenreifen

aus Edelstahl 18/10, seidenmatt poliert, konische Form, einseitig graduert in 1-Liter Schritten, mit fugenlosen Henkellaschen, Bodenreifen verstärkt

Bucket

18/10 stainless steel, satin polished finish, conical, graduated in litres inside with reinforced foot



Art-Nr. Part No.		∅ dia. cm	Höhe Height cm
416/010	10 l	30	26,5
416/012	12 l	31	29
416/015	15 l	32,5	33

Deckel

für Eimer 415 und 416, aus Edelstahl 18/10, hochglänzend

Lid

for bucket 415 and 416, 18/10 stainless steel, mirror polished finish



Art-Nr. Part No.	passend zu Matches
418/007	/007
418/010	/010
418/012	/012
418/015	/015

Eimer, säurefest

aus X5CrNiMo-Edelstahl, säurefest durch Molybdänlegierung, hochglänzend poliert, konische Form, mit geschlossenem Bodenreifen, einseitig graduert in 1-Liter Schritten

Heavy Duty Acid Resistant Bucket

molybdenum stainless alloy, mirror polished finish, conical, with sealed reinforced foot, graduated in litres inside



Art-Nr. Part No.		∅ dia. cm	Höhe Height cm
410/014	12 l	32	27

Deckel

für Eimer 410, aus Edelstahl 18/10, hochglänzend, Deckel mit seitlicher Laffe, daher sind die Eimer stapelbar

Lid

for 410 buckets, 18/10 stainless steel, mirror polished finish, design allows buckets to be stacked with lids on



Art-Nr. Part No.	passend zu Matches
---------------------	-----------------------

PRODUKTION
INGESTELLT
PRODUCTION
DISCONTINUED



Art-Nr. Part No.		Ø dia. cm	Höhe Height cm
419/010	10 l	26	29,5
419/012	12 l	27,5	33
419/015	15 l	30	30
419/020	20 l	32	38

Für diese Eimer sind keine Deckel verfügbar.
No lids are available for these buckets.



Eimer mit Schnaupe

aus Edelstahl 18/10, matt gebürstet, konisch, einseitig graduert mit 1-Liter Skalierung, gebördelter Rand, Bodenreifen mit Ablauflöchern für Spülwasser, schwere Qualität

Bucket with Spout

18/10 stainless steel, satin polished, conical, graduated in litres, rolled edge, with draining foot, heavy gauge



Art-Nr. Part No.		Ø dia. cm	Höhe Height cm
3071/007	7 l	24	25,5
3071/009	9 l	27	27



Kunststoffeimer

aus weißem Polyethylen, lebensmittelgeeignet, mit Bügel aus verzinktem Stahldraht

Plastic Bucket

white polyethylene, food safe, with zinc plated steel handle



Art-Nr. Part No.		Ø dia. cm	Höhe Height cm
3073/012	12 l	28	28
3073/015	15 l	30	31



Kunststoffeimer

aus weißem niederdichtem Polyethylen, lebensmittelgeeignet, mit Ausguss, mit Tragebügel aus verzinktem Stahldraht, geprägte Graduierung in Literschritten, stabile Qualität

Bucket

low density white polyethylene, food safe, with spout and zinc plated steel handle, graduated in litres, heavy gauge



Kunststoffeimer

aus weißem Polypropylen, lebensmittelgeeignet, leichte Qualität

Plastic Bucket

white polypropylene, food safe



Art-Nr. Part No.		∅ dia. cm	Höhe Height cm
3048/010	11 l	25	27

Kunststofftonne

aus weißem hochdichten Polyethylen, temperaturbeständig von -30°C bis +60°C, lebensmittelgeeignet, mit zwei Griffen, in- und aufeinander stapelbar

Bin

white high density polyethylene, withstands temperatures from -30°C to +60°C, food safe, stackable



Art-Nr. Part No.		∅ innen ∅ Inside cm	Höhe Height cm
3075/035	35 l	34,5	41
3075/050	50 l	40	47
3075/075	75 l	44,5	57

Folgende Größen können nur per Spedition versandt werden:
For these size pallet delivery only:

3075/100	100 l	47	67
3075/200*	200 l	67	80

Deckel bitte separat bestellen: / Please order lid separately:

3075/903	34,5
3075/905	40
3075/907	44,5
3075/910	47
3075/920*	67

*Die Größe hat keine Griffe und der Deckel keine Griffmulde.
*No handles on this size and no grip hole on the lid.

Rolluntersatz hierzu siehe Seite 489.
For matching castors see page 489.

Mengmulde

aus 1,5 mm starkem Edelstahl 18/10, Muldenkörper fugenlos, Untergestell aus Edelstahl 18/10, 1¼"-Ablauf mit Schraubverschluss, Muldentiefe des Beckens: 30 cm. Mit zwei ungelagerten Rädern Ø 125 x 30 mm aus Polypropylen und in der Standardausführung mit zwei Gleitfüßen. Ausführung 402 mit weichen Rollen Ø 125 x 35 mm (siehe Abb.)

Cleaning Trolley

1.5 mm thick 18/10 stainless steel, stainless steel subframe, 1¼" outlet with screw cap, depth: 30 cm, standard equipment: 2 fixed polypropylene wheels Ø 125 x 30 mm and 2 feet



Art-Nr. Part No.	Länge außen Outer Length cm	Breite außen Outer Width cm	Höhe gesamt Overall Height cm
---------------------	-----------------------------------	-----------------------------------	-------------------------------------

Mit 2 Rädern und 2 Gleitfüßen: / With 2 fixed wheels and 2 feet:

400/150	110	65	82,5	150 l
400/200	161	65	82,5	200 l

Mit 2 Bock- und 2 Lenkrollen mit Feststellern*:
With 2 fixed & 2 swivel wheels with brakes*

402/150	110	65	82,5	150 l
402/200	161	65	82,5	200 l

*Bei Feststellern sind die Rollen wegen der besseren Griffbarkeit nur in Stahlausführung mit Gummibereifung lieferbar.

*Due to better grip, wheels with brakes are only available in rubber

Versand nur per Spedition möglich.
Pallet delivery only.



Art-Nr. Part No.	Länge außen Outer Length	Breite außen Outer Width	Höhe gesamt Overall Height	
	cm	cm	cm	
1200/100	77,5	55	70,5	100 l

Versand nur per Spedition.
Pallet delivery only.



Vielzweckbecken

aus Edelstahl 18/10, Materialstärke 1,25 mm, mit Edelstahl 18/10-Untergestell, mit 4 Lenkrollen Ø 125 mm, davon 2 mit Feststellern, 1¼"-Ablaufventil aus Polyamid, Beckentiefe: 29 cm

Multipurpose Trolley

18/10 stainless steel, material thickness: 1.25 mm, 4 swivel wheels Ø 125 mm, (2 wheels with brakes), 1¼": ball valve outlet, depth: 29 cm



Art-Nr. Part No.	Länge außen Outer Length	Breite außen Outer Width	Höhe gesamt Overall Height	
	cm	cm	cm	
2401/240	85	65	63	240 l

mit Ø 125 mm Rollen: / Ø 125 mm wheels:
Versand nur per Spedition möglich.
Pallet delivery only.



Vielzweckbecken

aus 1,5 mm starkem Edelstahl 18/10, ohne Untergestell, mit 4 Lenkrollen, davon 2 mit Feststellern, mit 1¼"-Ablauf, Kugelventil mit Kugel aus Polyamid, Lieferung montiert

Multipurpose Trolley

1.5 mm thick 18/10 stainless steel, no subframe, with 4 swivel wheels (2 wheels with brakes), 1¼" outlet: ball valve



Art-Nr. Part No.	Länge Length	Breite Width	Höhe Height	
	cm	cm	cm	
2552/030	53	40	16	30 l
2552/040	53	40	22,5	40 l
2552/060*	53	40	37,9	60 l

*mit vier Rollen (ebenfalls stapelbar)
*with 4 wheels (stackable)



Transportbehälter

aus weißem Polypropylen, mit Tragegriffen, die den Behälterdeckel verriegeln, stapelbar, mit HACCP Colorclip und Beschriftungsfeld, lebensmittelgeeignet

Transport Container

white polypropylene, with handles which lock the lid, stackable, with HACCP colour clip and area to write on, food safe



Art-Nr. Part No.	Breite Width	Tiefe Depth	Höhe Height	
	cm	cm	cm	
2551/080	65,5	43,5	56	80 l
2551/100	70,5	46,5	58	100 l



Transportbehälter

aus Polypropylen, dicht verschließbar, lebensmittelgeeignet, mit HACCP Colorclip und Beschriftungsfeld, für Schüttgut, mit Rollen

Ingredient Bin

polypropylene, with tight fitting lid, with HACCP colour clip and area to write on, food safe, with wheels



Aufbewahrungsbehälter

Dosen, Kästen, Schalen, Boxen: **contacto** bietet die passenden Behältnisse um Lebensmittel, Speisen und Zutaten länger frisch zu halten und richtig zu lagern.

Storage Containers

Bain marie and storage containers as well as food carriers: **contacto** has the right choice of items to hold or store or move what's needed safely.

Wasserbadkasserolle

aus Edelstahl 18/10, seidenmatt glänzend, mit Hakengriffen, schwere Qualität

Bain Marie Pot

18/10 stainless steel, satin polished finish, with handles, heavy gauge



Art-Nr. Part No.		∅ außen ∅ Outside cm	Höhe Height cm
3036/010	1 l	10,5	15
3036/020	2 l	13,5	17
3036/030	3 l	16,5	18
3036/040	4 l	18,5	18,5
3036/050	5 l	18,5	22,5
3036/060	6 l	18,5	26,5
3036/080	8 l	21	27
3036/100	10 l	23	28

Weitere Größen auf Anfrage lieferbar.
Other sizes can be made on request.

Zylindrischer Behälter

aus Edelstahl 18/10, seidenmatt glänzend, ohne Griffe, schwere Ausführung

Bain Marie Pot

18/10 stainless steel, mirror polished finish heavy gauge



Art-Nr. Part No.		∅ außen ∅ Outside cm	Höhe Height cm
3037/010	1 l	10,5	15
3037/020	2 l	13,5	17
3037/030	3 l	16,5	18
3037/040	4 l	18,5	18,5
3037/050	5 l	18,5	22,5
3037/060	6 l	18,5	26,5
3037/100	10 l	23	28

Weitere Größen auf Anfrage lieferbar.
Other sizes can be made on request.

Deckel

für Kasserolle 3036, 3037 und 3003, mit Fallgriff

Lid

for 3036, 3037 and 3003, with handle



Art-Nr. Part No.	passend zu Matches
3038/010	/010
3038/020	/020
3038/030	/030
3038/050	/040 /050 /060
3038/080	/080
3038/100	/100

Art-Nr. Part No.	Länge Length cm	Breite Width cm	Höhe Height cm	
234/040	24	24	8	4 l
234/090	24	24	16	9 l
234/130	24	24	23,5	13 l

235/100 Deckel zur Serie A / Lid for series A

Art-Nr. Part No.	Länge Length cm	Breite Width cm	Höhe Height cm	
234/015	15,5	15,5	7,5	1,5 l
234/035	15,5	15,5	16	3,5 l
234/050	15,5	15,5	23,5	5 l

235/200 Deckel zur Serie B / Lid for series B

Art-Nr. Part No.	Länge Length cm	Breite Width cm	Höhe Height cm	
234/005	15,5	10,5	5,5	0,5 l
234/010	15,5	10,5	7,5	1 l
234/025	15,5	10,5	16	2,5 l

235/300 Deckel zur Serie C / Lid for series C

Art-Nr. Part No.	Portionsgröße Portion size	Ø dia. cm	Höhe Behälter Container Height cm
2012/121	0,6 l	12	6
2012/122	Deckel / Lid		
2012/124	Bügel für 4 Teile / Handle for 4 pcs.		

2014/141	0,9 l	14	6
2014/142	Deckel / Lid		
2014/144	Bügel für 4 Teile / Handle for 4 pcs.		

2016/161	1,2 l	16	6,5
2016/162	Deckel / Lid		
2016/164	Bügel für 4 Teile / Handle for 4 pcs.		

Zu dieser Serie werden nur Einzelteile angeboten.
Only individual parts are supplied for this range.

Art-Nr. Part No.	Portionsgröße Portion size	Ø dia. cm	Höhe gesamt Overall Height cm
---------------------	-------------------------------	-----------------	-------------------------------------

Mit drei Etagen: / 3 piece set:			
4012/123	0,6 l	11,5	24
4014/143	0,9 l	14	26

Mit vier Etagen: / 4 piece set:			
4012/124	0,6 l	11,5	30
4014/144	0,9 l	14	32,5
4016/164	1,2 l	16	31

Nur als Set lieferbar.
No loose parts available.



Bain Marie-Einsätze Serie A / groß
aus Edelstahl 18/10, seidenmatt poliert, stapelbar, schwere Qualität

Square Bain Marie Container
large, 18/10 stainless steel, satin polished finish, stackable. heavy gauge



Bain Marie-Einsätze Serie B / mittel
aus Edelstahl 18/10, seidenmatt poliert, stapelbar, schwere Qualität

Bain Marie Container
medium, 18/10 stainless steel, satin polished finish, stackable



Bain Marie-Einsätze Serie C / klein
aus Edelstahl 18/10, seidenmatt poliert, stapelbar, schwere Qualität

Bain Marie Container
small, 18/10 stainless steel, satin polished finish, stackable



Etagen-Essenträger

aus Edelstahl 18/10, hochglänzend, Gefäße auch ohne Deckel ineinander stapelbar

Food Carrier
18/10 stainless steel, mirror polished finish, stackable



Etagen-Essenträger

aus Edelstahl 18/10, hochglänzend, nur komplett lieferbar, bestehend aus Bügel, einem Deckel und drei bzw. vier Behältern

Food/Drinks Carrier
18/10 stainless steel, mirror polished finish, only available as set, consists of 1 carrying handle, 1 lid and 3 or 4 containers



Zutatenbehälter

aus Edelstahl 18/10, hochglänzend, mit 4 losen
Einsätzen von 14 x 10 x 5,6 cm Größe

Condiment Container

18/10 stainless steel, mirror polished finish,
with 4 individual inserts, size of insert: 14x10x5.6 cm



Art-Nr. Part No.	Länge Length cm	Breite Width cm	Höhe Height cm	Portionsgröße Portion size
212/004	40	14	6,2	0,75 l

Zutatenbehälter

aus Edelstahl 18/10, matt gebürstet, mit vier Einsatz-
schalen aus weißem Polypropylen, Scharnierdeckel aus
Polycarbonat, schwere Qualität

Condiment Container

18/10 stainless steel, brushed finish, with 4 plastic
inserts made of white polypropylene, hinged
polycarbonate lid, heavy gauge



Art-Nr. Part No.	Länge Length cm	Breite Width cm	Höhe Height cm	Portionsgröße Portion size
2120/004	30	14	8,5	0,5 l

Zutatenbehälter

ganz aus Polypropylen, vier Fächer

Condiment Container

polypropylene frame, 4 moulds



Art-Nr. Part No.	Länge Length cm	Breite Width cm	Höhe Height cm	Portionsgröße Portion size
1121/004	47	13	7,5	0,7 l

Deckel aus transparentem SAN bitte separat bestellen:
Please order transparent SAN lid separately:
1121/847

Zutatenbehälter

Gehäuse und Deckel aus Polycarbonat,
mit 0,5 l-Dosen aus Polypropylen

Condiment Dispenser

polycarbonate frame and lid,
with 0.5 L polypropylene containers



Art-Nr. Part No.	Länge Length cm	Breite Width cm	Höhe Height cm	Portionsgröße Portion size
1120/006	50	15,5	9	0,5 l

Zusätzliche lose Einsätze:
Additional spare containers:

6 Einsätze passen in Kasten: / 6 per dispenser:

1120/050 14 7,5 7,5 0,5 l

4 Einsätze passen in Kasten: / 4 per dispenser:

1120/075 14 11 7 0,75 l

3 Einsätze passen in Kasten: / 3 per dispenser:

1120/100 14 14,5 7 1 l

Aufbewahrungsdose

aus Edelstahl 18/10, seidenmatt poliert, stapelbar,
ideal zur Aufbewahrung im Kühlschrank

Freezer Container

18/10 stainless steel, satin polished finish, stackable



Art-Nr. Part No.	Länge Length cm	Breite Width cm	Höhe Height cm	Portionsgröße Portion size
1115/001	9,5	9,5	6	0,5 l
1115/002	19,5	9,5	6	1 l
1115/003	19,5	19,5	6	2 l

Deckel hierzu bitte separat bestellen: / Please order lids separately:

1116/001 9,5 9,5

1116/002 19,5 9,5

1116/003 19,5 19,5



Art-Nr. Part No.	Länge Length cm	Breite Width cm	Höhe Height cm	
310/008	8	8	8	0,46 l
310/014	14	14	14	2,5 l
310/020*	20	20	20	7,5 l

*mit zwei Fallgriffen
*with two drop down handles



Vorratsbehälter

mit Deckel, aus Edelstahl 18/10, hochglänzend, stapelbar

Square Storage Container

with lid, 18/10 stainless steel, mirror polished finish, stackable



Art-Nr. Part No.	Länge Length cm	Breite Width cm	Höhe Height cm	
1113/200	17	14	15	2 l
1113/300	17	14	21	3 l
1113/500	17	14	34,5	5 l



Vorrats-/Gewürzdose

aus weißem Polypropylen, mit dichtschießendem Steckdeckel aus Polyethylen, absolut geruchs- und geschmacksneutral, temperaturresistent von -40°C bis +95°C, unzerbrechlich, stapelbar, schwere Qualität

Storage Container

white polypropylene, with tight fitting polyethylene lid, temperature resistant from -40°C to +95°C, virtually unbreakable, heavy gauge



Art-Nr. Part No.	Länge innen Inner Length cm	Breite innen Inner Width cm	Höhe innen Inner Height cm	
1127/150	13	9	17	1,5 l
1127/390	21	14,5	15	3,9 l

Ersatzdichtungen auf Anfrage.
Spare gaskets on request.



Frischhaltedose

aus Polypropylen, rechteckig, stapelbar, luft- und wasserdicht schließend durch austauschbare Silikonichtung und vierseitigem Klick-Verschluss im Deckel, spülmaschinen-, mikrowellen- und gefriergeeignet

Storage Container

translucent polypropylene, rectangular, stackable, water and airtight lid with replaceable silicone gasket, four locking clips, dishwasher, microwave and freezer safe



Art-Nr. Part No.	Länge Length cm	Breite Width cm	Höhe Height cm	
1126/060	15	15	4	0,6 l
1126/100	18	12	6	1 l
1126/260	25	18	9	2,6 l
1126/370	30	23	9	3,7 l
1126/530	30	23	12	5,3 l
1126/900	30	23	18	9 l

Ersatzdichtungen auf Anfrage.
Spare gaskets on request.



Frischhaltedose

aus Polypropylen, rechteckig, flache Form, daher platzsparend in Kühlschränken nutzbar, stapelbar, luft- und wasserdicht schließend durch austauschbare Silikonichtung im Deckel, vierseitiger Klick-Verschluss, spülmaschinen-, mikrowellen- und gefriergeeignet

Storage Container

translucent polypropylene, rectangular, stackable, water and airtight lid with replaceable silicone gasket, four locking clips, dishwasher, microwave and freezer safe



Dressing-Behälter

aus Edelstahl 18/10, hochglänzend poliert

Salad Dressing Container

18/10 stainless steel, mirror polished finish



Art-Nr. Part No.		∅ dia. cm	Höhe Height cm
1015/100	1 l	10	15,5
1015/120	1,5 l	12	16,5

Deckel hierzu: / Matching lids:

1014/100	10
1014/120	12

Deckel mit Löffelausschnitt: / Notched Lids:

1014/101	10
1014/121	12

Vorratsdose

aus Edelstahl 18/10, hochglänzend, 0,6 mm stark, dichtschießender Acrylglas-Deckel mit Silikonichtung, nicht spülmaschinengeeignet

Storage Container

18/10 stainless steel, 0.6 mm thick, mirror polished finish, tight fitting acrylic lid with silicone seal, not dishwasher proof



Art-Nr. Part No.		∅ dia. cm	Höhe Height cm
1117/105	0,7 l	12,5	9,5
1117/125	1 l	12,5	12,5
1117/160	1,25 l	12,5	15,5
1117/215	1,7 l	12,5	19,5

Ätzbeschriftung auf Wunsch möglich.

Etching possible on request

Vorratsdose mit Sichtdeckel

aus Edelstahl 18/10, hochglänzend, mit dichtschießendem, geruchs- und feuchtigkeitsicheren Steckdeckel mit Sichtfenster aus Acryl, Deckel nicht spülmaschinengeeignet

Storage Container

18/10 stainless steel, mirror polished finish, tight fitting see through (acrylic) lid (not dishwasher safe)



Art-Nr. Part No.	∅ dia. cm	Höhe Height cm	
1119/110	8	11	0,5 l
1119/130	9	12,5	0,8 l
1119/170	12,5	17	2 l
1119/210	17,5	21	4,5 l

Vorratsdose, rund

aus transparentem Polypropylen, mit (separat erhältlichem) dichtschießendem Deckel, lebensmittelgeeignet, spülmaschinengeeignet

Round Storage Container

translucent polypropylene, with tight lid (supplied separately), food safe, dishwasher safe



Art-Nr. Part No.	∅ dia. cm	Höhe Height cm	
1124/004	18	21	4 l
1124/007	22	27	7 l
1124/015	30	30	15 l

Deckel hierzu bitte separat bestellen: / Please order matching lids separately:

1124/504	18
1124/507	22
1124/515	30

Frischhaltedose, rund

aus transparentem Polypropylen, stapelbar, luftdicht schließend durch austauschbare Silikonichtung und vierseitigem Klick-Verschluss im Deckel, spülmaschinen-, mikrowellen- und gefriergeeignet

Round Storage Container

translucent polypropylene, stackable, water and airtight lid with replaceable silicone gasket, four locking clips, dishwasher, microwave and freezer safe



Art-Nr. Part No.	∅ innen ∅ Inside cm	Höhe innen Inner Height cm	
1128/044	8	11,5	0,44 l
1128/071	10,5	9	0,71 l
1128/095	10,5	12,5	0,95 l
1128/120	10,5	18	1,2 l
1128/200	12,5	18	2 l

Ersatzdichtungen auf Anfrage.

Spare gaskets on request.

Art-Nr. Part No.	Länge außen Outer Length cm	Breite außen Outer Width cm	Höhe außen Outer Height cm
2510/600	60	40	7,5

Deckel separat bestellen: / Please order lid separately:
2510/601 60 40 2,5



Pizzaballenbehälter

aus weißem HD-Polyethylen, lebensmittelgeeignet, schwere Qualität

Pizza Dough Box

white high density polyethylene, food safe, heavy gauge



Art-Nr. Part No.	Länge außen Outer Length cm	Breite außen Outer Width cm	Höhe innen Inner Height cm
2515/622	60	40	21,5
2515/632	60	40	32
2515/642	60	40	42

2510/601 Stülpedeckel / Lid

Graue Ausführung siehe Seite 498
Grey version can be found on page 498.



Stapelkasten, weiß

aus weißem Polyethylen, mit Griffmulde, lebensmittel-echt

Food Box

white polyethylene, food safe



Art-Nr. Part No.	Länge außen Outer Length cm	Breite außen Outer Width cm	Höhe innen Inner Height cm	
2555/617	60	40	16	30 l
2555/621	60	40	21	40 l
2555/632	60	40	31,5	60 l

2555/960 Stülpedeckel / Lid



Stapelkasten, weiß

aus weißem HD-Polyethylen, lebensmittelecht, abgerundete Ecken erleichtern die Reinigung, weiter U-Rand mit Wasserablaufbohrung erleichtert den Transport, aufeinander stapelbar, geschlossene Ausführung ermöglicht vielfältige Lebensmittellagerung, schwere Qualität

Food Box

white polyethylene, stackable, with rounded corners for easy cleaning, wide U-shaped rim eases transport, drainage hole in curved rim, closed version for various types of food storage, heavy gauge, food safe



Art-Nr. Part No.	Länge Length cm	Breite Width cm	Höhe Height cm	GN
8033/023	35,5	32,5	20	2/3

8033/912 Ersatzsinsatz / Spare tray

Lieferung mit 8 Trägern 29x29 cm, nutzbar sind 3-4 Ebenen à 30 Eier im Behälter.
Supplied with eight 29x29 cm trays, 4 layers each with 30 eggs can be stored inside the box.



Eierbox

aus Polypropylen, Einsätze aus Polystyrol, zur HACCP-gerechten Aufbewahrung von Hühnereiern, fest-schließender Deckel, lebensmittelecht, spülmaschinen-geeignet, temperaturbeständig von -40°C bis +90°C

Egg Box

polyethylene, polystyrene inserts, HACCP compliant for storage of eggs, tight lid, food safe, dishwasher safe, withstands temperatures from -40°C to +90°C



Art-Nr. Part No.	Länge Length cm	Breite Width cm	Höhe Height cm	Farbe Colour
8034/030	30	30	5	weiß/white
8034/031	30	30	5	rot/red



Eiertablett

aus Polypropylen, zur Aufbewahrung von 30 Eiern gemäß HACCP, perforiert, lebensmittelecht, spülmaschinengeeignet

Egg Tray

polypropylene, takes 30 eggs as per HACCP, food and dishwasher safe



Eierbox

mit Deckel, aus Polypropylen, lebensmittelgeeignet, spülmaschinengeeignet, mit Einsatz zur fachgerechten Aufbewahrung von bis zu 10 Hühnereiern Größe M, stapelbar

Egg Box

including lid, polypropylene, food and dishwasher safe, takes 10 eggs, stackable



Art-Nr. Part No.	Länge Length cm	Breite Width cm	Höhe Height cm
8035/010	24,5	10,5	7

Beutelklammer mit Schütte

aus Polypropylen, original patentiertes twixit!® Seal & Pour, spülmaschinenfest, verschließt zuverlässig Beutel; der Inhalt (Zucker, Mehl, Kaffee, Müsli etc.) kann dosiert und wieder verschlossen werden

Bag Clip with Lid

polypropylene, the original twixit!® Seal & Pour does more than close bag, it allows you to pour contents from the bag without reopening the bag clip, it features a built-in pouring spout with resealable lid to keep contents fresh, dishwasher proof



Art-Nr. Part No.	Länge Length cm	Farbe Colour
7555/146	14	grün/green
7555/149	14	rot/red

Beutelklammer

aus Polypropylen, original patentiertes twixit!®, spülmaschinenfest, geeignet für Gefrierschrank und Mikrowelle, verschließt zuverlässig Plastikbeutel, Müllsäcke oder Spritzbeutel

Bag Clips

polypropylene, original patented twixit!® clips, freezer, microwave and dishwasher safe, all HACCP colours, to seal plastic, rubbish or piping bags



Art-Nr. Part No.	Länge Length
7557/011	11 cm
7557/014	14 cm

Preis für 20 Stück im Beutel: je Farbe vier Klammern für Fleisch ROT, Fisch BLAU, Geflügel GELB, Gemüse GRÜN, sonstige Lebensmittel WEISS

Priced and packed 20 pieces per bag 4 pcs. per colour: Raw meat RED, raw fish BLUE, cooked meat YELLOW, salad and fruit GREEN, others WHITE

Beutelklammer, groß

Original patentiertes twixit!®, spülmaschinenfest, geeignet für Gefrierschrank und Mikrowelle, verschließt zuverlässig besonders große Beutel und Säcke

Large Bag Clips

the original twixit!® Mega Clip, perfect for tightly closing extra large bags, keeping contents fresh, suitable for use in microwave ovens and freezers, dishwasher proof



Art-Nr. Part No.	Länge Length cm	Farbe Colour
7558/240	24	weiß/white
7558/241	24	schwarz/black
7558/243	24	blau/blue
7558/249	24	rot/red

Für dicke Papiertüten lässt sich das Innenteil entfernen.
Remove insert for thick paper bags

Art-Nr. Part No.	Ø dia. cm	Höhe Height cm	
4375/025	7	8	250 ml



Rückstellprobenbehälter

aus transparentem Polypropylen, mit Klemmdeckel

Sample Pot

transparent polypropylene, with lid



Art-Nr. Part No.		Farbe Colour
4371/051	Montag/Monday	blau/blue
4371/052	Dienstag/Tuesday	grün/green
4371/053	Mittwoch/Wednesday	rot/red
4371/054	Donnerstag/Thursday	braun/brown
4371/055	Freitag/Friday	grau/grey
4371/056	Samstag/Saturday	orange
4371/057	Sonntag/Sunday	schwarz/black
4371/750	Nachfüll-Set 7 Wochentage Mo-So / 7 rolls of 7 day week Mo-Su	



HACCP Etiketten

auf Rollen zu je 500 Etiketten, beschriftet mit den Wochentagen, unterschiedliche Farben für jeden Wochentag, nicht spülmaschinenfest, nicht wasserlöslich, leicht ablösbar, zum Kennzeichnen von Rückstellproben

Day Of The Week Labels

on rolls HACCP colour coded, 500 labels, week day (in German only) printed on label, not dishwasher safe, not dissolvable, easily removable



Etikettengröße: 30 x 24 mm, Kern Ø 40 mm, Ø außen 65 mm.
Label size: 30 x 24 mm, core Ø 40 mm, outer Ø 65 mm.

Art-Nr. Part No.	Länge Length cm	Breite Width cm	Höhe Height cm	Anzahl Fächer Slots
4374/445	44,5	13	11,5	7

Etiketten bitte separat bestellen.
Please order labels separately.



Etikettenspender

für 7 Rollen HACCP Etiketten mit maximal 55 mm Breite und 100 mm Rollendurchmesser und minimalen Kerndurchmesser 26 mm

Label Dispenser

takes 7 rolls of labels with 500 stickers, 4371 range, max. 55 mm width, 100 mm max. diameter and min 26 mm core diameter



Art-Nr. Part No.	Länge Length cm	Breite Width cm	Höhe Height cm
4373/500	56	25	21

Es passen 11 Etikettenrollen der Serie 4371/05x (500er Rolle).
Nicht geeignet für Alufolie.
Etiketten bitte separat bestellen.
Takes eleven 4371/05x (500 pcs. rolls).
Not suitable for aluminium foil.
Please order labels separately.



Abroller und Etikettenspender

aus schwarzem stabilem Polystyrol, rutschfeste Füße, für Etiketten ohne Trennfunktion, Etikettenrollen bis 80 mm Durchmesser in 3 Schächten mit 64 mm Breite und einem Schacht mit 170 mm Breite, Abroller für Plastikfolien bis 480 mm Breite und bis 80 mm Rollendurchmesser, bewegliches Messer, seitliche Schächte für Stifte, für Wandmontage vorbereitet

Label and Sheet Dispenser

black sturdy polystyrene, with non-slip feet, for non perforated labels in rolls up to 80 mm diameter in 3 slots with 64 mm slots and 170 mm slots, dispenser for rolls of cling film or kitchen paper up to 480 mm slots, 80 mm adjustable cutter, side slots for pens, two slots for wall fitting



Art-Nr. Part No.	Länge Length cm	Breite Width cm	Höhe Height cm
Für 30 cm Rollen: / For 30 cm wide rolls:			
7572/360	36	16	9
Für 45 cm Rollen: / For 45 cm wide rolls:			
7572/490	49	16	9



Abreißgerät

aus pulverbeschichtetem Stahlblech, mit Gummifüßen zur Nutzung als Standgerät, mit Säge, mit zwei Bohrungen zur Wandbefestigung, zum Einspannen von Rollen mit Folie, Backpapier oder Reinigungstüchern

Dispenser

powder coated steel, with rubber feet, but also with two holes for wall fitting, with serrated blade, for rolls of foil, cling film or kitchen paper





Dispenser

Punktgenau! Die Dispenser von **contacto** bringen das i-Punktchen auf die Speise. Die Handschrift der Küche gelingt durch feines genaues Dosieren der Saucen.

Sauce Dispensers

*Precise portion control. Whether self service is the order of the day, or finishing off a signature dish with an artistic flourish. **contacto** offers the right choice of items to meet the need.*

Dispenser und Dosierer sind wunderbare Hilfsmittel wenn es schnell und dennoch genau zugehen muss. Egal ob beim Imbissverkauf oder der Saucen-Posten in der Küche. Mit einem Pumpstoss, einer Dreh- oder Drückbewegung hat man die genaue Menge sekundenschnell und sauber parat.

Dispensers and portioners are wonderful tools when speed and accuracy are essential. No matter whether you're in a quick service or fine dining restaurant, a quick pump or squeeze will do the job.



- lagerfähig
- spülmaschinengeeignet
- hygienisch
- genau dosierend
- schnelles Handling
- *stackable*
- *dishwasher safe*
- *hygienic*
- *precise portioning*
- *quick handling*

Dispensersystem 'Saucenkuh'®

am Bügel aufhängbar, bestehend aus "Melkspender" aus Silikon und Nachfüllbehälter aus Polypropylen, zur hygienisch einwandfreien Portionierung von Senf, Ketchup, Mayonnaise oder Dressing durch leichten Fingerdruck, spülmaschinengeeignet

Sauce Dispenser

the original Saucenkuh® (sauce cow) from Contacto, polypropylene container with silicone dispenser, with hanger. Enables hygienic and precise portion control of all kinds of sauces and dressings with a light touch, dishwasher safe



Art-Nr. Part No.	Größe Size cm	Höhe Height cm	
1462/050	17 x 17	33	5,5 l
1462/903	Zubehör: Aufhängekette (ohne Abb.) / Chain (not shown)		
1462/901	Zubehör: Unterer Verschlusskappe / Lower Lock		
1462/904	Ersatzspender (Drücker mit Kolben und Adapter) / Flexible Nozzle (pusher plus adapter)		
1462/905	Ersatz-Nachfüllbehälter / Refill Container		
1462/937	Etikettensatz: / Spare set of labels		

Weitergehende Informationen auf www.saucenkuh.de.

Dispensersystem 'Saucenkuh'® DUO

Die Saucenkuh® im Paar am verchromtem Metallständer; zur hygienisch einwandfreien Portionierung von Senf, Ketchup, Mayonnaise oder Dressing durch leichten Fingerdruck, jeweils 5,5 Liter Fassungsvermögen, spülmaschinengeeignet

Sauce Dispenser Set

A pair of Saucenkuh® sauce dispensers, with chrome plated metal stand, enables hygienic and precise portion control of all kinds of sauces and dressings with a light touch, 5.5 litres capacity each, spülmaschinengeeignet



Art-Nr. Part No.	Breite Width cm	Höhe Height cm	Tiefe Depth cm
1463/002	34	75	26
1463/902		75	

Weitere Einzelteile siehe Artikel 1462.
Other spare parts: Please refer to part no. 1462.



Art-Nr. Part No.	Breite Width cm	Höhe Height cm	
Behälter mit Aufhängehaken, Dosierspender (Dispenser) und Etiketten: / Sauce dispenser and container with hook and labels:			
1464/027	12,5	44	2,7 l

Ersatz-Nachfüllbehälter: / Refill Container:			
1464/907	12,5	26	2,7 l

Ersatzspender (Silikonrührer mit Kolben und Schraubadapter): / Flexible Nozzle (silicone pusher plus adapter):			
1462/904			0,18 l

Weitere Einzelteile siehe Artikel 1462 und 1463.
Other spares: Please refer to part nos. 1462 + 1463.



Euterspender, klein

mit Aufhängeöse und -haken, bestehend aus "Melkspender" aus Silikon und Nachfüllbehälter aus Polypropylen, spülmaschinengeeignet, zur hygienisch einwandfreien Portionierung von Senf, Ketchup, Mayonnaise oder Dressing durch leichten Fingerdruck

Sauce Dispenser Set

the original Saucenkuh® (sauce cow) from Contacto, polypropylene container with silicone dispenser, with hanger, dishwasher safe, the dispenser enables hygienic and precise portion control of all kinds of sauces and dressings with a light touch



Art-Nr. Part No.	Breite Width cm	Höhe Height cm	
1462/937	10	4	



Etikettensatz Saucenkuh®

selbstklebende Etiketten, jeweils 1 Aufkleber mit: Senf, Mayonnaise, Ketchup, Pikant, Remoulade, Curry, Apfelmus

Set of Labels

for Saucenkuh® Dispenser System, only available in German language

Art-Nr. Part No.	Höhe gesamt Overall Height cm	Ø dia. cm	
Neutralweiß: / translucent:			
1460/251	0,25 l	19	5
1460/351	0,35 l	21	5,5
1460/701	0,7 l	24	6,5

Rot: / Red:			
1460/252	0,25 l	19	5
1460/352	0,35 l	21	5,5
1460/702	0,7 l	24	6,5

Gelb: / Yellow:			
1460/253	0,25 l	19	5
1460/353	0,35 l	21	5,5
1460/703	0,7 l	24	6,5



Quetschflasche

aus Polyethylen, mit Schraubdeckel und Verschlusskappe, unbedruckt, spülmaschinengeeignet

Sauce Bottle

polyethylene, with screw top, dishwasher safe



Art-Nr. Part No.	Länge Length cm	Breite Width cm	Höhe gesamt Overall Height cm	Anzahl Fächer Slots
2743/202	17	9,5	5,5	2
2743/203	24	9,5	5,5	3

Quetschflaschen bitte separat bestellen:
Please order squeeze bottles separately:

1460/251	Quetschflasche 0,25l, neutral / Squeeze Bottle 0.25l, transparent
1460/252	Quetschflasche 0,25l, rot / Squeeze Bottle 0.25l, red
1460/253	Quetschflasche 0,25l, gelb / Squeeze Bottle 0.25l, yellow



Gestell für Quetschflaschen

aus Edelstahl, hochglänzend poliert, für Quetschflaschen aus Polyethylen

Condiment Holder

stainless steel, mirror polished finish, for polyethylene bottles



Enghalsflasche

aus hochdichtem Polyethylen, transparent, mit extra langer Tropfspitze zur punktgenauen Feindosierung, mit Verschlusskappe, lebensmittelecht, spülmaschinengeeignet

Mini Sauce Bottle

high density translucent polyethylene, with screw top and cap, long fine tip for precise control, food and dishwasher safe



Art-Nr. Part No.		Ø dia. cm	Höhe Height cm
1459/070	70 ml	3,5	13
1459/120	120 ml	4,2	14,5

Quetschflasche

aus farbigem Polyethylen, mit Schraubkappe, wiederverschließbar, erleichterte Handhabung durch abgeflachte Form, schwere Qualität

Sauce Bottle

polyethylene, with lockable cap, easy to grip by flat body, heavy gauge



Art-Nr. Part No.	Ø dia. cm	Höhe Height cm		Farbe Colour
1465/064	8,5	19,5	0,6 l	ocker/brown
1465/065	8,5	19,5	0,6 l	rot/red
1465/100	9,5	25,5	1 l	crèmeweiß/white
1465/104	9,5	25,5	1 l	ocker/brown
1465/105	9,5	25,5	1 l	rot/red
1465/901	Ersatzkappe / Spare Cap			

Quetschflasche

aus Polyethylen, mit Silikonmembran, breite verschließbare Einfüllöffnung auf der Bodenseite zum Nachfüllen und einfachen Reinigen, lebensmittelgeeignet, spülmaschinengeeignet

Sauce Bottles

polyethylene, with silicone membrane, wide opening in base enables refilling and makes cleaning easier



Art-Nr. Part No.		Höhe Height cm	Ø dia. cm
1473/035	0,35 l	16,5	6
1473/050	0,5 l	21	6
1473/059	0,6 l	21	7
1473/070	0,7 l	21	7,5
1473/095	0,95 l	21,5	8,5

Dosier- und Vorratsflasche

Behälter und Deckel aus Polypropylen, farbige Ausgießer aus SAN-Kunststoff mit 10 mm Ø Ausgussöffnung, Lieferung jeweils im Satz bestehend aus einem weißen Behälter mit buntem, gleichfarbigem Deckel und Ausgießer, zum Lagern, Mixen und Dosieren von Flüssigkeiten

Speed Pours Set

polypropylene bottle and lid, SAN (plastic) 10 mm diameter coloured pourer nozzle, set includes a white bottle with lid and pourer of same colour, for storage, mixing, pouring and serving drinks



Art-Nr. Part No.	Höhe Height cm	Ø dia. cm	Farbe Colour
Satz für 1 l Volumen: / 1 L sets:			
5843/101	33,5	9	braun/brown
5843/103	33,5	9	weiß/white
5843/104	33,5	9	gelb/yellow
5843/105	33,5	9	rot/red
5843/106	33,5	9	orange
5843/107	33,5	9	blau/blue
5843/109	33,5	9	grün/green
Satz für 2 l Volumen: / 2 L sets:			
5843/201	35	12,5	braun/brown
5843/203	35	12,5	weiß/white
5843/204	35	12,5	gelb/yellow
5843/205	35	12,5	rot/red
5843/206	35	12,5	orange
5843/207	35	12,5	blau/blue
5843/209	35	12,5	grün/green

Ausgießer auf Anfrage.
Spare pourer nozzles on request.

Art-Nr. Part No.	Länge Length cm	Breite Width cm	Höhe Height cm
Mit einem Behälter: / Single:			
1325/001	20	18,5	21,5
Mit zwei Behältern: / Double:			
1325/002	36	20	21,5
Gestelle ohne Behälter, ohne Pumpe:			
Unit excluding container and pump:			
1325/817	20	18,5	21,5
1325/835	36	20	21,5



Saucendispenser

aus Edelstahl, allseitig geschlossen, mit 200 mm tiefen GN 1/6 Einsätzen aus Polycarbonat, mit im Deckel integrierter Pumpe 1312 aus Polypropylen, für Portionsgröße 30 ml

Sauce Dispenser

stainless steel, complete with 200 mm 1/6 GN polycarbonate container, fitted with polypropylene 30 ml pump, ideal for thin sauces



Art-Nr. Part No.	Breite Width cm	Höhe Height cm	Portionsgröße Portion size
237/035	15,5	29	3,5 l 30 ml
237/050	15,5	36,5	5 l 30 ml
237/200	Ersatzdeckel / Spare lid		
1311/030	Ersatzpumpenaufsatz / Spare pump		
1310/030	Pumpenaufsatz von 1320 / Pump as of 1320 (orange)		
(Ersatz-) Behälter / (Spare) containers:			
234/035	15,5	16	3,5 l
234/050	15,5	23,5	5 l



Dispenser

aus Edelstahl 18/10, mit Griffen, mit auswechselbarem robustem Pumpenaufsatz 1311 aus Kunststoff, es kann auch die Pumpe 1310 montiert werden

Sauce Dispenser

18/10 stainless steel, with handles, heavy gauge plastic pump



Art-Nr. Part No.	GN	Höhe gesamt Overall Height cm
7050/016	1/6	3,4 l 31
7016/200	Ersatzbehälter / Spare container	
7050/176	Ersatzdeckel / Spare lid	
1310/030	Ersatzpumpe / Spare Pump	



Saucendispenser GN 1/6

bestehend aus 200 mm tiefem Behälter GN 1/6 aus Edelstahl 18/10, Polycarbonatdeckel und schwenkbarem Pumpenaufsatz 1310 für 30 ml Portionen

GN 1/6 Sauce Dispenser

18/10 stainless steel, GN 1/6 200 mm deep container, with polycarbonate lid and polypropylene pump for 30 ml portions



Art-Nr. Part No.	Ø innen Ø Inside cm	Höhe Behälter Container Height cm
Mit Griffen: / With handles:		
3050/004	4 l	17,6
3050/006	6 l	17,6
3050/010	10 l	20,8
ohne Griffe / Without handles:		
3051/004	4 l	17,6
3051/006	6 l	17,6
3051/010	10 l	20,8

Behälter ohne Griffe und Ersatzteile auf Anfrage.
Für den Einbau in Theken fordern Sie bitte ein Muster an.
Containers without handles and spare parts available on request.



Runder Dispenser/Dosierspender

ganz aus Edelstahl 18/10, selbstansaugende Pumpe, einstellbare Dosiermenge, schwenkbarer Auslaufhahn, thekeneinbaufähig, hitzeresistent bis +70°C, mit (3050) oder ohne (3051) Griffflaschen

Round Dispenser

18/10 stainless steel, adjustable pump with variable portion control, can be fitted into counters, heat resistant up to +70°C, with (3050) or without (3051) handles



Art-Nr. Part No.	Länge Length cm	Breite Width cm	Höhe gesamt Overall Height cm
3065/035	15	15	29 3,5 l
3065/050	15	15	36,5 5 l

Ersatzteile auf Anfrage.
Für den Einbau in Theken fragen Sie bitte bei uns die genauen Maße bzw. fordern Sie Muster an.
Spare parts available on request.



Dosierspender, rechteckig

ganz aus Edelstahl 18/10, selbstansaugende Pumpe, einstellbare Dosiermenge, schwenkbarer Auslaufhahn, thekeneinbaufähig, hitzeresistent bis +70°C, mit Griffen

Square Dispenser

18/10 stainless steel, adjustable pump with variable portion control, can be fitted into counters, heat resistant up to +70°C, with handles



Dispenser

Behälter aus weißem Polyethylen, mit dicht-schließendem Steckdeckel, mit auswechselbarem robustem Pumpenaufsatz 1310, es kann auch die Pumpe 1311 montiert werden

Sauce Dispenser

white polyethylene, watertight lid, with replaceable robust pump attachment, pump 1311 can also be mounted



Art-Nr. Part No.	Breite Width cm	Höhe Height cm	Portionsgröße Portion size	
1320/330	20	35	3 l	30 ml
1320/530	20	48	5 l	30 ml

1320/901	Ersatzdeckel / Spare Lid			
1320/902	Edelstahl 18/10-Deckel für Pumpe 18/10 Stainless steel lid for pump			
1310/030	Ersatzpumpenaufsatz / Spare pump			
1311/030	Pumpenaufsatz von 237 Pump as shown on item 237			

Ersatzbehälter: / Spare containers:				
1113/200	17	15	2 l	
1113/300	17	21	3 l	
1113/500	17	34,5	5 l	

Dispenser, eckig

mit Pumpaufsatz 1312, leicht zerlegbar, auf verschließbaren Dosen aus Polypropylen, lebensmittelgeeignet

Sauce Dispenser

with pump, easy to take apart, fitted into polypropylene containers, food safe



Art-Nr. Part No.	Länge Length cm	Breite Width cm	Höhe Height cm	
Mit 30 ml Pumpe: / With 30 ml pump:				
1324/150	13	9 cm	29	1,5 l
1324/390	21	14,5 cm	27	3,9 l

Dispenser, rund

mit Pumpaufsatz 1312, leicht zerlegbar, auf verschließbaren Dosen aus transparentem Polypropylen, lebensmittelgeeignet

Sauce Dispenser

with pump, easy to take apart, fitted into polypropylene containers, food safe



Art-Nr. Part No.	∅ innen ∅ Inside cm	Höhe Height cm	
Mit 5 ml Pumpe: / With 5 ml pump:			
1323/044	8	19	0,44 l
1323/095	10,5	20	0,95 l

Mit 30 ml Pumpe: / With 30 ml pump:			
1323/120	10,5	30,5	1,2 l
1323/200	12,5	30,5	2 l

Eimer mit Dispenser

Eimer aus weißem Polyethylen mit Drahtbügel, Pumpe 1311 aus Polypropylen, lebensmittelgeeignet, mit Aluminium-Deckel (nicht spülmaschinengeeignet)

Sauce Dispenser

white polyethylene bucket with wire handle, fitted with polypropylene pump, food safe, aluminium lid (not dishwasher safe)



Art-Nr. Part No.	∅ innen ∅ Inside cm	Höhe gesamt Overall Height cm
Eimer 10 Liter mit Deckel und 30 ml Pumpe: 10 l dispenser with lid and 30 ml pump:		
1315/010	10 l	25

1315/280	Deckel mit Pumpe / Lid with pump	
1315/928	Deckel / Lid	
1311/030	Pumpenaufsatz 30 ml / Pump 30 ml	
3048/010	Eimer 10 l, lose / 10 l Bucket only	

Kühlbehälter

isolierter Behälter aus PP-Kunststoff, hält Temperaturen bis +4°C bei +21°C Außentemperatur über max. 8 Stunden bei vorhergehender Tiefkühlung auf -18°C, nicht spülmaschinengeeignet

Cold Crock

insulated PP container, keeps temperatures below +4°C in +21°C environment for max. 8 hours, when previously cooled down to -18°C, not dishwasher safe



Art-Nr. Part No.	∅ dia. cm	Höhe Height cm
Weißer Vorratsbehälter mit Untersetzer, ohne Deckel, ohne Pumpe: White crock with under-plate, without lid, without pump:		
5840/002	1,9 l	18,5

Deckel für Pumpe aus klarem Polycarbonat: Lid for pump - clear polycarbonate:		
5840/801	16	
Pumpe zu Deckel /801: / Pump for /801 lid:		
1312/030		



Art-Nr. Part No.	Länge Length cm	∅ Nozzle mm	Durchlauf Portion size	Höhe Behälter Container Height cm
1310/030	28	14	30 ml	13,5 - 31

Vertikales Pumprohr kann durch mitgeliefertes Rohr verlängert werden.

Supplied with additional matching 20 cm tube.



Pumpaufsatz

aus Polypropylen, lebensmittelgeeignet, spülmaschinengeeignet, Dosierer bewegt sich mit Pumpenhub, hohe Kraftübertragung bei zähen Flüssigkeiten, schwere robuste Qualität

Sauce Dispenser Pump

polypropylene, with polyethylene dip tube and metal spring, food safe, accurate portion control, ideal for thick sauces, food and dishwasher safe, heavy gauge



Art-Nr. Part No.	Länge Length cm	∅ Nozzle mm	Durchlauf Portion size	Höhe Behälter Container Height cm
1311/030	17	7	30 ml	4 - 21,5

Vertikales Pumprohr kann durch mitgeliefertes Rohr verlängert werden.

Supplied with additional matching 23 cm tube



Pumpaufsatz, starr

aus Polypropylen, Dosierer bleibt starr in Position beim Pumpenhub, für Portionsgröße 30 ml, lebensmittelgeeignet, spülmaschinengeeignet, schwere robuste Qualität

Sauce Dispenser Pump

polypropylene, with polyethylene dip tube and metal spring, fixed nozzle, food safe, accurate 30 ml portion control, ideal for thin sauces, food and dishwasher safe, heavy gauge



Art-Nr. Part No.	Länge Length cm	∅ Nozzle mm	Durchlauf Portion size	Höhe Behälter Container Height cm
1312/005	33,5	2	5 ml	6,5 - 26,5
1312/030	25	4	30 ml	13,5 - 31



Pumpaufsatz

aus Polypropylen, lebensmittelgeeignet, spülmaschinengeeignet

Sauce Dispenser Pump

polypropylene, food safe, ideal for thin sauces, dishwasher safe



Art-Nr. Part No.	Höhe Height cm	∅ dia. cm	
8091/150	34	12,5	1,5 l



Drucksprüngerät, lebensmittelgeeignet

aus weißem lebensmittelgeeigneten Polyethylen, für dünnflüssige Lösungen (kein Öl), mit Handpumpe zum Aufbauen von maximal 0,2 MPa (2 bar) Arbeitsdruck, mit verstellbarer Düse, Sicherheitsventil und Standfuß

Compression Spray

white polyethylene, for thin fluids (except oil), pressure can be built up to 0.2 MPa (2 bar), adjustable nozzle, safety valve



Schüsseln, Seiher & Siebe

Mixen, mengen, schlagen, rühren, waschen, sieben und vieles mehr. Hier finden Sie garantiert die richtige Schüssel für Ihren jeweiligen Einsatzzweck.

Bowls, Basins & Sieves

Mixing, beating, stirring or sieving. Here you are guaranteed to find the right vessel to suit.

Schüssel

tiefe konische Form, aus Edelstahl 18/10, seidenmatt poliert, offener, leicht gewölbter Rand

Open Edge Bowl

deep conical, 18/10 stainless steel, satin polished



Art-Nr. Part No.	Ø Boden Ø Base cm	Höhe Height cm	Ø innen Ø Inside cm	
507/120	7,5	7	12	0,5 l
507/140	9,5	7,5	15	0,75 l
507/160	9,5	8	15	1 l
507/180	11,5	9,5	18	1,5 l
507/200	11,5	11,5	19,5	2 l
507/220	14	12,5	22	3 l
507/240	15,5	13,5	24,5	4 l
507/260	18	13	26,5	5 l
507/280	19,5	14,5	28,5	6 l
507/300	20	16,5	31	8 l
507/320	19,5	18	31	9 l
507/360	21,5	18	35,5	11 l
507/380	21,5	20	37	14 l

Schüssel

flache konische Form, aus Edelstahl 18/10, seidenmatt poliert, offener, leicht gewölbter Rand

Open Edge Bowl

shallow, 18/10 stainless steel, satin polished



Art-Nr. Part No.	Ø Boden Ø Base cm	Höhe Height cm	Ø innen Ø Inside cm	
1525/140	9,5	6	14	0,5 l
1525/150	9,5	7	15	0,75 l
1525/160	11,5	7	16,5	1 l
1525/220	16	7	22	2 l
1525/240	16	9,5	24	3 l
1525/260	18	12,5	26	4,5 l
1525/300	21,5	12	30,5	6 l
1525/301	19,5	14,5	28,5	6 l
1525/320	21	14	32	8 l
1525/380	28,5	13	38	11 l
1525/400	28,5	15,5	40	14 l

Schüssel, graduiert

flache konische Form, aus Edelstahl 18/10, seidenmatt glänzend, offener, leicht gewölbter Rand, Skala: Liter, Pint, Quarts & Cups, schwere Qualität

Open Edge Bowl

shallow, 18/10 stainless steel, satin polished, graduated inside in litres, pints, quarts & cups



Art-Nr. Part No.	Ø Boden Ø Base cm	Höhe Height cm	Ø innen Ø Inside cm	
1528/150	11,5	8,5	19	1,5 l
1528/300	13	11	24	3 l
1528/500	16,5	12,5	28	5 l
1528/800	22	13	34	8 l

Graduierung: in 0,5 l-Schritten
Graduated each 0.5 L

Schüsseln

Bowls and Basins



Art-Nr. Part No.	∅ Boden ∅ Base cm	Höhe Height cm	∅ innen ∅ Inside cm	
2050/160	8	6,5	14	0,6 l
2050/180	10	7	16	1 l
2050/200	11	8	17,5	1,3 l
2050/220	12	8,5	20	1,75 l
2050/240	13	10	22	2,5 l
2050/280	15	10	25	3,5 l
2050/320	19	12	29	5,5 l
2050/360	21	14	32,5	8 l
2050/400	23	14	36	9,5 l



Schüssel

tiefe konische Form, aus Edelstahl 18/10, hochglänzend poliert, gebördelter Rand, mittelschwere Qualität

Bowl

deep conical, 18/10 stainless steel, mirror polished finish, medium gauge



Art-Nr. Part No.	∅ Boden ∅ Base cm	Höhe Height cm	∅ innen ∅ Inside cm	∅ außen ∅ Outside cm
500/160	9	6	14,5	0,75 l
500/180	11,5	7	16	1 l
500/200	13	8	18	1,5 l
500/240	16	9	21	2,5 l
500/280	18	10,5	24,5	4 l
500/320	20,5	12,5	28	6 l
500/360	24	14	32,5	9 l
500/400	26	15	35	12 l
500/420	27	16	41	17 l



Schüssel

bauchige Form, aus Edelstahl 18/10, hochglänzend, mit gebördeltem, griffigem Rand, schwere Qualität

Rolled Edge Bowl

18/10 stainless steel, mirror polished, heavy gauge



Art-Nr. Part No.	∅ Boden ∅ Base cm	Höhe Height cm	∅ innen ∅ Inside cm	
2635/140	9	6,5	14	0,5 l
2635/160	9	7	16	0,8 l
2635/180	11	7,5	18	1,25 l
2635/200	12	8,5	20	1,4 l
2635/240	14	10	24	3 l
2635/280	16	12	28	5 l
2635/320	19	13	32	7,5 l
2635/360	21	15	36	10 l



Schüssel, leicht

aus Edelstahl, mit gebördeltem Rand

Bowl

stainless steel, with rolled edge



Art-Nr. Part No.	∅ Boden ∅ Base cm	Höhe Height cm	∅ innen ∅ Inside cm	
Seidenmatt gebürstet: / Satin polished:				
1551/160	6	7	16	0,9 l
1551/200	8	9	20	2 l
1551/240	11	11	24	3,5 l
1551/280	13	13	28	5 l
Hochglänzend: / Mirror polished finish:				
1551/320	16	13	33	7,5 l
1551/360	17,5	14,5	36	10 l
1551/400	19,5	16,5	40	14 l
1551/450	22	18	45	20 l
1551/500	24,5	20	50	25 l



Mixerschüssel

aus Edelstahl 18/10, halbkugelförmig mit flachem Boden, mit breitem, griffigen, gebördeltem Rand

Mixing Bowl

18/10 stainless steel, satin polished, hemispherical with flat base, with wide rolled edge



Art-Nr. Part No.	∅ Boden ∅ Base cm	Höhe Height cm	∅ innen ∅ Inside cm	
2626/175	10	10,5	17,5	1,5 l
2626/225	12	13	22,5	3 l



Servierschüssel, doppelwandig

aus Edelstahl 18/10, innen und außen seidenmatt gebürstet, mit hochglänzendem Rand, schwere Qualität, ideal für Buffets

Insulated Bowl

18/10 stainless steel, satin polished finish with wide mirror polished rim, double walled, heavy gauge, suitable for buffets



Art-Nr. Part No.	∅ Boden ∅ Base cm	Höhe Height cm	∅ innen ∅ Inside cm	
5355/150	9	5	15	0,5 l
5355/200	11	6,5	20	1,2 l
5355/250	13,5	8	24,5	2,5 l
5355/300	17,5	10	31	5 l
5355/380	21,5	12	37,5	10 l



Servierschüssel

aus transparentem Polycarbonat, spülmaschinenfest, benutzbar von -40°C bis +99°C, nicht mikrowellengeeignet, sehr robuste Qualität

Salad/Fruit Bowl

transparent polycarbonate, virtually unbreakable, with stands temperatures -40°C and +99°C, dishwasher proof, not suitable for microwave ovens



Mixerschüssel

aus Edelstahl 18/10, hochglänzend, hohe schmale Form mit extra breitem Griffrand, ideal zur Verwendung mit Mix- oder Pürierstab bzw. Handmixgeräten

Mixing Bowl

18/10 stainless steel, mirror polished, cylindrical with wide edge, easy to grip



Art-Nr. Part No.		∅ innen ∅ Inside cm	Höhe Height cm
509/110	1,4 l	11	15

Schlagmaschinenkessel

gemäß DIN 8770/EN454, aus Edelstahl 18/10, matt poliert, mit gebördeltem Rand, extra schwere Qualität, Herstellung auf Original-WALTER-Werkzeugen

Planetary Mixing Bowl

conforms to EN 454, 18/10 stainless steel, matt polished, with rolled edge extra heavy gauge



Art-Nr. Part No.		∅ innen ∅ Inside mm	Höhe Height mm	∅ außen ∅ Outside mm
5621/010	10 l	265	200	278
5621/016	16 l	300	250	315
5621/020	20 l	315	300	330
5621/025	25 l	355	285	370
5621/032	32 l	355	355	370
5621/040	40 l	400	355	415
5621/050	50 l	400	435	415

Planetenrührkessel WALTER 5619 (andere Abmessungen) mit Gesenk im Boden auf Anfrage.

Schneeschlagkessel

aus Edelstahl 18/10, matt poliert, mit zwei Griffen, schwere Qualität

Hemispherical Mixing Bowl

18/10 stainless steel, matt polished, with two handles, heavy gauge



Art-Nr. Part No.		∅ innen ∅ Inside cm	Höhe Height cm
2000/200	2 l	20	10
2000/220	2,5 l	22	10,5
2000/250	5 l	25	14
2000/280	7 l	28	17
2000/320	10 l	32	20
2000/360	14 l	36	22
2000/400	22 l	40	24

Ringständer

aus Edelstahl, matt poliert, schwere Qualität, für Schüsseln von ∅ 22 bis 40 cm

Stand for Mixing Bowl

stainless steel, matt polished, for bowls of ∅ 22 - 40 cm



Art-Nr. Part No.	Höhe Height cm	∅ außen ∅ Outside cm	∅ innen ∅ Inside cm
2002/220	4,5	22	14

Ringständer

aus Edelstahl, hochglänzend, für Schüsseln von ∅ 18 bis 26 cm

Stand for Mixing Bowl

stainless steel, mirror polished, for bowls of ∅ 18 - 26 cm



Art-Nr. Part No.	Höhe Height cm	∅ außen ∅ Outside cm	∅ innen ∅ Inside cm
2022/155	2,5	15,5	11

Rührschüssel

aus Edelstahl 18/10, matt gebürstet, mit festgeschweißtem Bodenring, mit einem Fallgriff/-öse, gebördelter Rand, extra schwere Qualität

Mixing Bowl

18/10 stainless steel, matt polished finish, with welded foot, with one drop down handle, rolled edge, extra heavy gauge



Art-Nr. Part No.	∅ innen ∅ Inside cm	Höhe gesamt Overall Height cm	
2055/200*	20	12	2 l
2055/250	25	15	5 l
2055/280	28	19	7 l
2055/320	32	22	10,5 l
2055/360	36	23	14,5 l

* ohne Griff-Öse
*without handle

Rührschüsseln, Wannen

Bowls, Basins



Art-Nr. Part No.	∅ dia. cm	Höhe Height cm	
1347/240	24	14,5	4 l



Rührschüssel

aus weißem Polypropylen, Boden und Griff mit rutschfester Beschichtung

Mixing Bowl

white polypropylene, base and handle have non-slip coating



Art-Nr. Part No.	∅ innen ∅ Inside cm	Höhe Height cm	
1340/160	16	8	1 l
1340/200	20	11	2,5 l
1340/240	24	13	4,5 l
1340/280	28	14,5	6 l
1340/320	32	16	9 l
1340/360	36	18	13 l



Rührschüssel

aus transparent-weißem Polypropylen, mikrowellengeeignet, bruchsicher, stapelbar

Mixing Bowl

translucent white polypropylene, heavy duty



Art-Nr. Part No.	∅ dia. cm	passend zu Matches
1341/160	19	1340/160
1341/200	24	1340/200
1341/240	28	1340/240
1341/280	32,5	1340/280
1341/320	36	1340/320
1341/360	40	1340/360



Deckel zu Rührschüssel

passend zur Rührschüssel 1340, aus transparent-weißem Polypropylen

Lid for 1340 Bowl

translucent polypropylene



Art-Nr. Part No.	∅ innen ∅ Inside cm	Höhe Height cm	
545/400	40	20	16 l
545/450	45	22	24 l
545/500	50	24	32 l



Wanne, rund

aus Edelstahl 18/10, matt poliert, mit zwei Griffen, mit gebördeltem Rand, schwere Qualität

Round Bowl

with two handles, 18/10 stainless steel, matt polished, rolled edge, heavy gauge



Art-Nr. Part No.	∅ dia. cm	Höhe Height cm	
3001/400	40	17	16 l
3001/500	50	21	30 l
3001/600	60	28	56 l



Wanne/Fettschüssel, rund

aus Edelstahl 18/10, seidenmatt poliert, mit gebördeltem Rand, mit zwei Fallgriffen und Bodenring, extra schwere Qualität

Round Large Bowl

with foot, two drop down handles, 18/10 stainless steel, satin polished, with foot, two drop down handles, extra heavy gauge



Salatschleudern

Die Salatschleudern von **contacto** sind ideal um Salat und Gemüse schnell und in großen Mengen zu trocknen.

Salad Spinners

*Speed and volume: the characteristics of **contacto**'s salad spinners.*

In der Gastronomie hat man größere Mengen an Lebensmittel zu verarbeiten. Dies muss schnell, sauber und effektiv erfolgen. Mit den großen Salatschleudern von **contacto** hat man all die Ansprüche perfekt vereint. Salat oder Gemüse nach dem Waschen in die Schleuder geben, Deckel schließen, kurbeln, fertig! Das überschüssige Wasser läuft über einen Schlauch ab.

*Foodservice requires processing large quantities of food. This must be done quickly, cleanly and effectively. With the large salad spinners from **contacto**, all the requirements are perfectly combined. After washing your salad, place it in the basket, close the lid, and turn the handle. Excess water drains off via a hose.*



- robust
- zuverlässig
- HACCP Farbe
- auseinandernehmbar
- vibrationsarm
- sturdy
- reliable
- HACCP Colour
- can be taken apart
- low vibration

Salatschleuder

aus lebensmittelechtem Polypropylen mit einer Mechanik aus Edelstahl und Polyamid, zum Abschleudern von Salat und Gemüse nach dem Waschen, Wasser läuft über einen Schlauch ab, innerer Korb entnehmbar

Salad Spinner/Dryer

polypropylene body with stainless steel and polyamide mechanism, for drying salad and vegetables, water drains through tube, inner basket can be removed



Art-Nr. Part No.		Ø dia. cm	Höhe Height cm
für 2-3 Salatköpfe / for 2-3 heads of lettuce			
1343/015	12 l / 10 l	32	43
für 4-5 Salatköpfe: / for 4-5 head of lettuce			
1343/027	25 l / 20 l	43	45

Angaben beziehen sich auf Gesamt- sowie Nutzvolumen.
Actual working capacity 10 L + 20 L respectively.

Haltegestell für Salatschleuder

aus 4 mm starkem Edelstahl 18/10, auf 4 großen Gummifüßen, sichert die Salatschleuder auch auf nassen Abstellflächen und Tischen

Salad Spinner foot

4 mm thick 18/10 stainless steel, 4 large rubber feet, holds the spinner during operation even on wet surfaces and tables



Art-Nr. Part No.	Ø max. cm	Höhe Height cm	passend zu Matches
1344/265	23,8	4	1343/015
1344/315	31,5	4	1343/027

Art-Nr. Part No.		∅ innen ∅ Inside cm	Höhe Height cm
1110/320	8 l	32	19
1110/360	12 l	36	21
1110/400	16 l	40	23
1110/450	24 l	45	25
1110/500	32 l	50	27



Seiher

aus Edelstahl 18/10, seidenmatt poliert, mit angeschweißtem Bodenring, 3 mm Seiten-/Bodenlochung, schwere Qualität

Colander

18/10 stainless steel, satin polished finish, with welded foot, 3 mm holes in sides and base, heavy gauge



Art-Nr. Part No.		∅ dia. cm	Höhe Height cm
1112/320	6 l	32	17
1112/360	9 l	36	18,5
1112/400	14 l	40	21



Seiher

aus Edelstahl, innen glänzend, außen matt poliert

Colander

stainless steel, mirror polished inside, matt outside



Art-Nr. Part No.		∅ dia. cm	Höhe Height cm
6081/320	8 l	31,5	16
6081/360	12 l	36	18,5
6081/400	16 l	40	20
6081/450	24 l	45	22,5
6081/500	32 l	49,5	24



Seiher

aus Edelstahl 18/10, matt poliert, 3,5 mm Seiten- und Bodenlochung, mit gebördeltem Rand und eingepressten Standfüßchen, schwere Qualität

Colander

18/10 stainless steel, matt polished finish, 3.5 mm holes in sides and base, with built in feet, heavy gauge



Art-Nr. Part No.		∅ innen ∅ Inside cm	Höhe Height cm
6088/400	16 l	38	18
6088/500	30 l	48	21
6088/600	56 l	58	28



Fettseiher

aus Edelstahl 18/10, matt poliert, mit angeschweißtem Bodenring, 4 mm Bodenlochung, mit gebördeltem Rand, schwere Qualität

Colander/Fat Strainer

18/10 stainless steel, matt polished finish, with welded foot, with rolled edge, 4 mm holes in base, heavy gauge



Art-Nr. Part No.	∅ dia. cm	Höhe Height cm	∅ Boden ∅ Base cm
6077/400	40	17,5	18



Pommes frites-Seiher

ganz aus Edelstahl, seidenmatt poliert, mit Handgriff, Sammelbehälter abnehmbar, 4 mm Perforation

Chip / French Fries Colander

stainless steel, satin polished, with handle, removable base, 4 mm holes



Art-Nr. Part No.		∅ dia. cm	Höhe Height cm
3070/360	10 l	36	19



Seiher

aus weißem Polypropylen, lebensmittelecht, mit zwei Griffen

Strainer/Colander

white polypropylene, food safe, with two handles



Seiher

tiefe Form, aus Edelstahl, hochglänzend, mit angeschweißtem Fuß, 3-4 mm Seiten- und Bodenlochung

Deep Colander

stainless steel, mirror polished, with welded foot, 3-4 mm holes in sides and base



Art-Nr. Part No.		∅ dia. cm	Höhe Height cm
6079/220	3 l	21	14
6079/270	4 l	25	16
6079/380	15 l	36	22

Seiher

aus Edelstahl 18/10, hochglänzend, flache Form, mit breitem, gebördeltem Rand, Loch ∅ 3 mm, Bodenlochung dichter als Wandlochung

Shallow Colander

18/10 stainless steel, mirror polished finish, shallow, with wide rolled edge and welded foot, 3 mm holes



Art-Nr. Part No.		∅ dia. cm	Höhe gesamt Overall Height cm
6086/210	1,7 l	21	9,5
6086/250	3,5 l	25	12
6086/290	5,5 l	30	13,5
6086/340	9 l	34	15,5

Seiher

aus Edelstahl 18/10, hochglänzend, 2,5 mm Seiten- und Bodenlochung, mit eingepressten Standfüßchen

Colander

18/10 stainless steel, mirror polished finish, 2.5 mm holes in sides and base, with built in feet



Art-Nr. Part No.		∅ dia. cm	Höhe Height cm
6080/280	5 l	26,5	13

Seiher

aus Edelstahl 18/10, hochglänzend, fugenlos aus einem Stück mit eingepressten Bodenfüßchen, mit 3 mm-Lochung

Colander

18/10 stainless steel, mirror polished finish, one piece, with built in feet, 3 mm holes



Art-Nr. Part No.		∅ innen ∅ Inside cm	Höhe außen Outer Height cm	∅ Boden ∅ Base cm
1330/240	3 l	24	9	17

Stielsieb

aus Edelstahl 18/10, matt poliert, mit Flachstiel, mit breitem Haken, 3 mm-Lochung, mit verstärktem Rand, schwere Qualität

Strainer

18/10 stainless steel, matt polished finish, flat handle, with wide hook, with 3 mm holes, reinforced edge, heavy quality



Art-Nr. Part No.	∅ innen ∅ Inside cm	Höhe Height cm	Stiellänge Handle Length cm	
124/240	24	12	26	3,5 l
124/280	28	14	26	5 l

Stielsieb

aus Edelstahl 18/10, hochglänzend, 3 mm Lochung, mit Drahtgriff (∅ 6 mm), mit verstärktem Rand, Haken, schwere Qualität

Strainer

18/10 stainless steel, mirror polished finish, 3 mm perforations, wire handle ∅ 6 mm, hook, heavy gauge



Art-Nr. Part No.	∅ innen ∅ Inside cm	Höhe Height cm	Stiellänge Handle Length cm	
4110/240	24	12	16	3,5 l

Art-Nr. Part No.	∅ außen ∅ Outside cm	Höhe Height cm	Stiellänge Handle Length cm	
1153/120	12	8,5	12	0,25 l
1153/140	14	11	15	0,5 l

Mit Stützstiel zum Einhängen in den Topfrand: / With supporting bar:

1153/160	16	15	16	1 l
1153/180	18	16,5	17	1,2 l
1153/200	20	18	18	1,5 l
1153/230	23	20	18	2,5 l
1153/250	25	23	22	3,5 l
1153/260	27	25	22	4,5 l

Art-Nr. Part No.	∅ dia. cm	Höhe Height cm	Stiellänge Handle Length cm	
2660/160	15,5	14,5	18	0,8 l
2660/180	17,5	18	23,5	1,2 l
2660/200	19,5	19,5	23,5	1,7 l
2660/240	23	24	23,5	3,2 l

Art-Nr. Part No.	∅ dia. cm	Höhe Height cm	Stiellänge Handle Length cm	
---------------------	-----------------	----------------------	-----------------------------------	--

PRODUKTION
EINGESTELLT
PRODUCTION
DISCONTINUED

Art-Nr. Part No.	∅ dia. cm	Höhe Height cm	Stiellänge Handle Length cm	
1250/200	19,5	14,5	18,5	1,4 l
1250/240	23	19	18,5	2,5 l

Art-Nr. Part No.	∅ innen ∅ Inside cm	Höhe Height cm	Stiellänge Handle Length cm	
1163/200	20	15	23,5	1,5 l
1163/240	23	19,5	23	2,7 l

Art-Nr. Part No.	∅ außen ∅ Outside cm	Höhe Height cm	Stiellänge Handle Length cm	
987/175	18	10	18	1 l



Spitzsieb mit Flachstiel

aus Edelstahl 18/10, seidenmatt poliert, mit 1,5 mm Lochung auch in der Kegelspitze

Conical Strainer

18/10 stainless steel, satin polished finish, with 1.5 mm holes (including the tip)



Spitzsieb mit Rundstiel

aus Edelstahl 18/10, seidenmatt poliert, mit gebördeltem Rand, mit 1 mm-Lochung, ohne Lochung in Kegelspitze, schwere Qualität

Conical Strainer

tubular handle, 18/10 stainless steel, satin polished finish, with rolled edge, 1 mm holes (excluding the tip)



Spitzsieb, extra fein

aus Edelstahl 18/10, seidenmatt poliert, 1,3 mm Lochung - auch in der Kegelspitze, die extreme Lochdichte (verdoppelte Passierfläche) erzeugt einen Gazesiebefeekt bei höchster Stabilität

Conical Strainer, extra fine

18/10 stainless steel, satin polished, 1.3 mm holes including the tip, very high density (double the usual) which has the same effect as a mesh, but much more robust



Gazespitzsieb mit Flachstiel

aus Edelstahl 18/10, seidenmatt poliert, mit flachem Griff, mit Stützstiel zum Einhängen in Topfrand, mit feinem Gewebe, Maschenweite 0,8 mm

Chinois

18/10 stainless steel, satin polished finish, with flat handle, with support handle to hook into the edge of the pot, fine mesh, mesh size 0.8 mm



Gazespitzsieb mit Rundstiel

aus Edelstahl 18/10, mit rundem Griff und gebördeltem Rand, mit extrafeinem, formbeständigen Gewebe, Maschenweite 0,7 mm, schwere, verstärkte Qualität,

Chinois

18/10 stainless steel, with tubular handle and rolled edge, strong fine mesh, mesh size 0.7 mm, heavy gauge,



Passiersieb, spitz

ganz aus Edelstahl, mit breitem hochglänzenden Rahmen, Drahtstiel mit handlichem Rohrgriff und Öse, Gewebe extrafein, Maschenweite 0,6 mm, schwere Qualität

Strainer

all stainless steel, wide mirror polished edge, wire stem with tube handle and eyelet, extra fine mesh, mesh size 0.6 mm, heavy gauge,



Ständer

für Siebe und Fondantrichter, aus Edelstahl 18/0, elektropoliert, stabile Qualität, geeignet für alle Größen von Spitz- und Gazesieben sowie Fondantrichtern

Stand for Chinois and Fondant Funnels

18/0 stainless steel, electro-polished, for all sizes of our chinois and fondant funnels, sturdy quality



Art-Nr. Part No.	∅ dia.	Höhe Height
1170/180	18 cm	28 cm

Holz-Stößel

für Spitzsiebe, aus fein geschliffenem Buchenholz, unlackiert, nicht spülmaschinengeeignet

Beechwood Pestle

for conical strainers, unlacquered, not dishwasher proof



Art-Nr. Part No.	Länge Length	∅ dia.
824/260	29 cm	4 cm

Passiertuch

ganz aus natürlichem gazeartigen Rohleinen, nicht gebleicht, hochwertiges deutsches Fabrikat, Schnittkanten gesäumt, kochfest, zum Passieren von Speisen

Straining Cloth

pure natural linen, not bleached, washable



Art-Nr. Part No.	Größe Size
6580/080	77 cm x 83 cm

Passiersieb, runde Form

ganz aus Edelstahl 18/10, feines Gewebe, Maschenweite 1,3 mm, stabile Qualität

Strainer

18/10 stainless steel, fine mesh, mesh size 1.3 mm, sturdy quality



Art-Nr. Part No.	∅ außen ∅ Outside	Stiellänge Handle Length
3190/100	0,15 l	10
3190/120	0,25 l	12
3190/140	0,4 l	14
3190/160	0,7 l	16
3190/180	1 l	18
3190/200	1,5 l	20
3190/220	2 l	22
3190/240	2,5 l	24
3190/260	3,5 l	26

Passiersieb, runde Form

ganz aus Edelstahl, mit breitem hochglänzenden Rahmen, Gewebe extrafein, Maschenweite 0,6 mm

Strainer

stainless steel, mirror polished edge, fine mesh, mesh size 0.6 mm



Art-Nr. Part No.	∅ außen ∅ Outside	Stiellänge Handle Length
3130/130	0,3 l	12,5
3130/150	0,5 l	15,5
3130/180	1 l	18

Passiersieb, spitz, klein

ganz aus Edelstahl 18/10, mittelfeines Gewebe, Maschenweite 1,7 mm, stabile Qualität

Strainer

18/10 stainless steel, medium mesh, mesh size 1.7 mm, sturdy quality



Art-Nr. Part No.	∅ dia.	Länge Length
3120/065	0,1 l	7,5

Art-Nr. Part No.	Ø dia. cm	Stiellänge Handle Length cm
3160/220	3,5 l	22
3160/260	4,5 l	26
3160/300	7 l	30
3160/340	9,5 l	34

Siebe mit mittlerem Gewebe (1,5 mm).
Complete strainer with medium mesh (1.5 mm).



Großküchensieb

ganz aus Edelstahl 18/10, Gestell elektropoliert, hygienische Konstruktion, Griff ist handlich oval, besonders stabil durch Verstärkungsbügel, zusätzliche Einsätze (siehe 3161) einfach auswechselbar, standardmäßig mit mittlerem Gewebe, Maschenweite: 1,3 mm ausgestattet, stabile Qualität

Soup Strainer

18/10 stainless steel, electro-polished reinforced frame, hygienic design, oval ergonomic handle, easily interchangeable mesh (see 3161), standard delivery with medium mesh, mesh size: 1.3 mm, solid quality



Art-Nr. Part No.	Ø dia. cm	Maschenweite Mesh size mm
3161/221	22	Gewebe mittel/Medium mesh 1,3
3161/222	22	Gewebe fein/Fine mesh 0,6

3161/260	26	Gewebe grob/Coarse mesh 3
3161/261	26	Gewebe mittel/Medium mesh 1,3
3161/262	26	Gewebe fein/Fine mesh 0,6

3161/300	30	Gewebe grob/Coarse mesh 3
3161/301	30	Gewebe mittel/Medium mesh 1,3
3161/302	30	Gewebe fein/Fine mesh 0,6

3161/340	34	Gewebe grob/Coarse mesh 3
3161/341	34	Gewebe mittel/Medium mesh 1,3
3161/342	34	Gewebe fein/Fine mesh 0,6



Einsätze zu Sieb 3160

ganz aus Edelstahl 18/10, einfach auswechselbar, stabile Qualität

Replacement Mesh for 3160

18/10 stainless steel, easily interchangeable, sturdy gauge



Art-Nr. Part No.	Ø dia. cm	Stiellänge Handle Length cm
3185/300	3 l	30
3185/350	5 l	35



Großküchensieb

ganz aus Edelstahl 18/10, feines Gewebe, Maschenweite 1,1 mm, starke, stabile Qualität

Large Soup Strainer

18/10 stainless steel, fine mesh, mesh size 1.1 mm, sturdy quality



Art-Nr. Part No.	Ø dia. cm	Stiellänge Handle Length cm
3199/300	5 l	30
3199/350	8 l	35



Großküchensieb

ganz aus Edelstahl 18/10, außen Stützgewebe, innen mittelfeines Gewebe Maschenweite 1,3 mm, mit Verstärkungsrahmen

Large Soup Strainer

all 18/10 stainless steel, outer robust mesh, inner medium mesh, mesh size 1.3 mm, with reinforcing framework



Art-Nr. Part No.	Länge Length	Ø dia. cm
825/160	16 cm	9,5 cm



Passierholz

für Rundsiebe, aus fein geschliffenem Buchenholz, unlackiert, nicht spülmaschinengeeignet

Beechwood Pestle

for round strainers, unacquered, not dishwasher proof



Rundsieb

ganz aus Edelstahl, hochglänzend, mit feinem Gewebe, Maschenweite 1 mm, ohne Bodenabstand

Flour Sieve - fine mesh

stainless steel, mirror polished finish, fine mesh, mesh size 1 mm, mesh covers the base,



Art-Nr. Part No.	∅ dia.	Höhe Height
1080/200	22 cm	6,5 cm
1080/250	25,5 cm	7 cm
1080/300	30 cm	7,5 cm
1080/400	40 cm	8 cm

Rundsieb

ganz aus Edelstahl 18/10, hochglänzend poliert, mit gewalztem Streckgewebe, Füllhöhe 5 cm, mit hohem Bodenabstand, extra schwere Qualität

Flour Sieve

18/10 stainless steel, mirror polished finish, with rolled stretched mesh, filling height 5 cm, with high ground clearance, extra heavy gauge



Art-Nr. Part No.	∅ dia.	Höhe gesamt Overall Height
Fein (Lochmaß 0,5 x 1 mm): / Fine (holes 0.5 x 1 mm):		
2605/250	25 cm	10 cm
2605/300	30 cm	10 cm
2605/350	35 cm	10 cm
Mittelfein (Lochmaß 1 x 2,5 mm): / Medium (holes 1 x 2.5 mm):		
2604/300	30 cm	10 cm
2604/350	35 cm	10 cm
Grob (Lochmaß: 2,5 x 3 mm): / Coarse (holes 2.5 x 3 mm):		
2606/250	25 cm	10 cm
2606/300	30 cm	10 cm
Extra grob (Lochmaß 9 x 7 mm): / Extra Coarse (holes 9 x 7 mm):		
2607/300	30 cm	10 cm
2607/350	35 cm	10 cm

Rundsieb

aus 3 mm starkem weißen Polypropylen, mit Kunststoffgewebe, Maschenweite 1 mm, Füllhöhe 6,5 cm, niedriger Bodenabstand,

Flour sieve

3mm thick white polypropylene, with plastic mesh, mesh size 1 mm, filling height 6.5 cm, low ground clearance



Art-Nr. Part No.	∅ dia.	Höhe gesamt Overall Height
7615/230	23 cm	8,2 cm

Einhand-Drücksieb

aus Edelstahl 18/0, hochglänzend, Gewebe aus 18/10, Maschenweite 0,9 mm, Griff mit Feder, robuste Qualität

Flour Sifter

18/0 stainless steel, mirror polished finish, mesh 18/10, mesh size 0.9 mm, handle with spring



Art-Nr. Part No.	∅ dia. cm	Höhe Height cm
Mit einem Sieb: / One mesh:		
2603/085	0,3 l	8,5
Mit drei Sieb-Ebenen: / Three mesh:		
2603/100	0,5 l	10
		13

Passiergeräte

Moulins/Vegetable Sieves



Art-Nr. Part No.	∅ dia. cm	Höhe Height cm
557/300	5 l	30

Mit drei Einsatzscheiben Lochdurchmesser 1,5 mm, 2,5 mm und 4 mm. Ersatzteile auf Anfrage.

With three sieves (1,5 mm, 2,5 mm and 4 mm perforations).

Spare parts on request. Tin-plated version available on request.



Passiergerät

aus Edelstahl 18/10, mit einem seitlichen Griff, geliefert mit drei auswechselbaren Klingenschleifsätzen (∅ 14 cm), geeignet für Topfdurchmesser 20-24 cm, schwere Qualität

Moulin/Vegetable Sieve

18/10 stainless steel, with three interchangeable sieves (∅ 14 cm), with one side handle, for 20-24 cm pot diameters, heavy gauge

18/10
EDELSTAHL
STAINLESS STEEL

Art-Nr. Part No.	∅ dia. cm	Höhe Height cm	∅ Loch ∅ Hole mm
559/360	36 cm	18	

Lieferung erfolgt ohne Lochscheiben, daher bitte Siebeinsätze separat bestellen:

Delivery without any sieve/grater, therefore please order separately:

559/910	8	1
559/915	8	1,5
559/920	8	2
559/930	8	3
559/940	8	4

Tin-plated version available on request.



Passiergerät

aus Edelstahl 18/10, auswechselbare Klingenschleifsätze aus Edelstahl 18/10 erhältlich, ein seitlicher Griff, Leistung: 5 kg pro Minute, 6 Liter Fassungsvermögen, geeignet für Topfdurchmesser 28-30 cm, schwere Qualität

Moulin/Vegetable Sieve

18/10 stainless steel, interchangeable sieves available, with one side handle, 5 Kg per min. for up to 50 portions, 6 Litres capacity, for 28-30 cm pot diameters, heavy gauge

18/10
EDELSTAHL
STAINLESS STEEL

Art-Nr. Part No.	∅ dia. cm
590/260	26
590/320	32



Passiergerät

aus Edelstahl 18/10, hochglänzend poliert, mit Griff und Haken, mit zwei auswechselbaren Sieb-Einsätzen mit 2 und 3 mm Löchern, schwere Qualität

Moulin/Vegetable Sieve

18/10 stainless steel, mirror polished finish, with handle and hook, with two interchangeable sieves with 2 and 3 mm holes, heavy gauge

18/10
EDELSTAHL
STAINLESS STEEL

Art-Nr. Part No.	∅ dia. cm	Höhe Height cm
555/200	2 l	20

Mit je einem groben (Lochdurchmesser 4 mm), feinen (3 mm) und extrafeinen (2 mm) Einsatz.

Keine Zusatz-/Ersatzteile lieferbar.

With three sieves (2 mm, 3 mm and 4 mm perforations)

No spare/additional parts available.



Passiergerät

aus Edelstahl 18/10, außen hochglänzend, mit Doppelflügeltechnik mit drei auswechselbaren Sieb-Einsätzen (∅ 13 cm), geeignet für Töpfe mit Durchmesser 14-16 cm

Moulin/Vegetable Sieve

18/10 stainless steel, outside mirror polished, with three interchangeable sieves, suitable for pots with 14-16 cm diameter

18/10
EDELSTAHL
STAINLESS STEEL

Abfüllhilfen & Streuer

First-In First-Out: Mit den Abfüllhilfen von **contacto** werden Sie kinderleicht Ihre Lebensmittel messen, entnehmen und umfüllen können.

Scoops & Measures

First-In First-Out: With **Contacto's** scoops, graduated measures and scales, you will easily be able to measure all the ingredients you need.



Küchenschaufel

aus Edelstahl 18/10, hochglänzend, mit Flachgriff

Scoop

18/10 stainless steel, mirror polished finish, with flat handle

18/10
EDELSTAHL
STAINLESS STEEL



Art-Nr. Part No.	∅ Schaufel ∅ Scoop cm	Länge Length cm	Schaufellänge Scoop Length cm	Portionsgröße Portion size
1037/050*	5	18	10	0,1 l
1037/080	7,5	26	14,5	0,4 l
1037/100	10,5	33	15	0,85 l
1037/110	12	36	23	1,45 l
1037/155	15	39	25	2,3 l

*mit Hohlgriff

*with tubular handle

Küchenschaufel

aus Edelstahl 18/10, hochglänzend poliert, mit schrägem Hohlgriff

Scoop

18/10 stainless steel, mirror polished finish, with angled hollow handle

18/10
EDELSTAHL
STAINLESS STEEL



Art-Nr. Part No.	∅ Schaufel ∅ Scoop cm	Länge Length cm	Schaufellänge Scoop Length cm	Portionsgröße Portion size
50/100	10	37	19,5	0,8 l
50/120	12	37,5	21	1,3 l
50/140	14	39,5	22	1,8 l
50/160	15,5	40,5	24	2,1 l

Küchenschaufel

aus Edelstahl, matt poliert, fugenlos

Scoop

stainless steel, matt polished finish

INOX
EDELSTAHL
STAINLESS STEEL



Art-Nr. Part No.	∅ Schaufel ∅ Scoop cm	Länge Length cm	Schaufellänge Scoop Length cm	Portionsgröße Portion size
1137/070	7	28	16	0,4 l
1137/130	13	33	20	1,65 l

Art-Nr. Part No.	∅ Schaufel ∅ Scoop cm	Länge Length cm	Schaufellänge Scoop Length cm	Portionsgröße Portion size
1131/110	11	30	16	0,8 l



Küchenschaufel

aus Edelstahl, hochglänzend, mit Hohlgriff

Scoop

stainless steel, mirror polished finish, with hollow handle



Art-Nr. Part No.	∅ Schaufel ∅ Scoop cm	Länge Length cm	Schaufellänge Scoop Length cm	Portionsgröße Portion size
1036/090	9,5	26,5	14	0,6 l
1036/110	12	31	17,5	1 l
1036/130	15	35	21	1,5 l



Küchenschaufel

aus Edelstahl 18/10, hochglänzend, fugenlose Schaufel mit Flachgriff, schwere Qualität

Scoop

18/10 stainless steel, mirror polished, with flat handle, seamless scoop, heavy gauge



Art-Nr. Part No.	∅ Schaufel ∅ Scoop cm	Länge Length cm	Schaufellänge Scoop Length cm	Portionsgröße Portion size
1038/090	9,5	17,5	14	0,5 l
1038/110	11	18	17	1 l
1038/130	14	20,5	21	1,5 l



Sackschaufel

aus Edelstahl 18/10, hochglänzend, fugenlose Schaufel mit offenem angesetztem Hohlgriff, schwere Qualität

Scoop

18/10 stainless steel, mirror polished, seamless scoop, with open hollow handle, heavy gauge



Art-Nr. Part No.	Länge Length cm	Schaufelmaß Scoop dimension cm	Portionsgröße Portion size
1029/145	14,5	8,5 x 5	0,02 l
1029/185	18,5	10,5 x 5,5	0,08 l
1029/210	21	12 x 7	0,11 l
1029/250	25	15 x 9	0,25 l
1029/265	26,5	17 x 10	0,4 l
1029/310	31	18 x 10,5	0,4 l
1029/350	35	22 x 13,5	0,75 l



Abwiegeschaufel

aus Aluminiumguss, nicht spülmaschinengeeignet

Scoop

cast aluminium, not dishwasher safe



Art-Nr. Part No.	Schaufelmaß Scoop dimension cm	Länge Length cm	Portionsgröße Portion size
5855/250	15 x 8	25	0,25 l
5855/300	19 x 10	31	0,5 l
5855/350	21 x 12	35	0,7 l



Abwiegeschaufel

aus weißem Polypropylen, schwere harte Ausführung

Scoop

white polypropylene



Art-Nr. Part No.	Schaufelmaß Scoop dimension cm	Länge Length cm	Portionsgröße Portion size
5364/150	8 x 5	15	0,06 l
5364/200	11 x 6,5	20	0,14 l
5364/400	23 x 15	40	1,5 l



Abwiegeschaufel

aus weißem Polypropylen

Scoop

white polypropylene



Küchenschaufel

aus 3 mm starkem weißen Polystyrol, robuste Qualität

Scoop

white polystyrene, sturdy quality

PS
POLYSTYRENE



Art-Nr. Part No.	Schaufelmaß Scoop dimension cm	Länge gesamt Total Length cm	Portionsgröße Portion size
1039/285	17 x 12	29	0,6 l
1039/350	23,5 x 15	36	2,7 l

Schüttgutschaufel

aus Polycarbonat, lebensmittelgeeignet, spülmaschinengeeignet, mit Skalierung

Scoop

polycarbonate, food safe, dishwasher safe, graduated

PC
POLY-CARBONATE
SPÜLMASCHINE
DISHWASHER
1,5
LITER
GRADUIERT
GRADUATED



Art-Nr. Part No.	Schaufelmaß Scoop dimension cm	Höhe Height cm	Portionsgröße Portion size
1728/060	28 x 12	11,5	0,6 l

Dosierschaufel

aus Edelstahl 18/10, hochglänzend, mit Drahtgriff, geeignet für Gewürzdosen oder auch als Eisschaufel

Scoop

18/10 stainless steel, mirror polished, wire handle

18/10
EDELSTAHL
STAINLESS STEEL



Art-Nr. Part No.	Schaufelmaß Scoop dimension cm	Länge gesamt Total Length cm	Portionsgröße Portion size
1033/120	6 x 3	11	0,03 l
1033/135	8,5 x 4,5	13,5	0,05 l
1033/170	9 x 5,5	16	0,1 l

Messlöffelsatz

aus Edelstahl 18/10, Löffel hochglänzend, Stiele matt poliert

Measuring Spoon Set

18/10 stainless steel, bowl mirror polished, handles satin polished

18/10
EDELSTAHL
STAINLESS STEEL



Art-Nr. Part No.	Länge Length
1566/004	13 cm

Skalierung: 1 Esslöffel, 1 Teelöffel,

½ Teelöffel, ¼ Teelöffel

Measures: Table Spoon, Tea Spoon,

½ Tea Spoon, ¼ Tea Spoon

Eisschaufel

aus Edelstahl, hochglänzend, mit 5 mm-Lochung, mit handlichem Hohlgriff

Ice Scoop

stainless steel, mirror polished, 5 mm perforations, with hollow handle

INOX
EDELSTAHL
STAINLESS STEEL



Art-Nr. Part No.	Länge Length cm	∅ Schaufel ∅ Scoop cm	Schaufellänge Scoop Length cm
1031/100	18,5	5	10

Art-Nr. Part No.	Schaufelmaß Scoop dimension cm	Länge gesamt Total Length cm	Portionsgröße Portion size
1035/110	12 x 6	21	0,1 l
1035/140	14 x 7,5	23	0,2 l
1035/155	15,5 x 8,5	24,5	0,25 l
1035/180	18 x 10	29	0,35 l
1035/220	22 x 13	35	0,5 l

Die innenliegende Kunststoffversiegelung erlaubt ein kurzzeitiges Erhitzen bis 200°C.
Temperature up to 200°C due to plastic gauge inside.



Eis-/ Mehrzweckschaufel

aus Edelstahl 18/10, hochglänzend, fugenlose sehr hygienische Verbindung von Schaufel und Hohlgriff, mit Aufhängeöse, extra schwere Qualität

Scoop

18/10 stainless steel, mirror polished, seamless fixed handle, with hanging loop, extra heavy gauge



Art-Nr. Part No.	Schaufelmaß Scoop dimension cm	Länge gesamt Total Length cm	Portionsgröße Portion size
5848/175	11 x 7	25,5	0,175 l



Mehrzweckschaufel

aus glasklarem Polycarbonat, auch als Eisschaufel und zum Abfüllen in schmale Behältnisse zu verwenden

Scoop

clear polycarbonate



Art-Nr. Part No.	Ø dia. cm	Höhe Height cm	Stiellänge Handle Length cm	
5455/070	16,5	5,5	13	0,7 l
5455/100	18,5	6	13	1 l
5455/150	20	8	13	1,5 l
5455/200	22,5	8	13	2 l
5455/300	23	10	13	3 l



Schöpfer

aus Edelstahl 18/10, hochglänzend, mit glattem Schüttrand, handlicher Rohrgriff, schwere Qualität

Scoop

18/10 stainless steel, mirror polished, with open pouring edge, with hollow handle, heavy gauge



Art-Nr. Part No.	Ø dia. cm	Höhe Height cm	Stiellänge Handle Length cm	
5454/100	15	8,5	19	1 l

Graduierung: 0,25 l, 0,5 l, 0,75 l, 1 l
Graduated every ¼ L



Schöpfer, graduert

aus Edelstahl 18/10, hochglänzend, abgeflachter Boden, mit Schüttrand und Hakengriff, schwere Qualität

Scoop

18/10 stainless steel, mirror polished, with pouring edge and flat handle, heavy gauge



Art-Nr. Part No.	Ø dia. cm	Höhe Height cm	Stiellänge Handle Length cm	
1329/200	18,5	12	10	2 l



Schöpfer

aus weißem Polypropylen, beidseitiger Ausguss, innen graduert, spülmaschinen- und mikrowelleneignet

Scoop

white polypropylene, with two pouring lips, graduated inside, suitable for dishwasher and microwaves



Messbecher mit Fuß

aus Edelstahl 18/10, seidenmatt poliert,
innen graduert in Liter und Pint

Graduated Measure

18/10 stainless steel, satin polished,
graduated inside in pints and litres



Art-Nr. Part No.		Höhe Height
551/050*	0,5 l	11 cm
551/100**	1 l	14 cm
551/150**	1,5 l	16 cm
551/200**	2 l	20 cm

* Messstriche und Zahlen alle 100 ml

** Messstriche alle 100 ml, Zahlen alle 500 ml

* graduated and numbered every 100 ml

** graduated every 100 ml, numbers every 500 ml

Messbecher

aus Edelstahl 18/10, seidenmatt poliert, innen graduert,
mit offenem Griff, stapelbar

Graduated Measure

18/10 stainless steel, satin polished, graduated inside,
open handle, stackable



Art-Nr. Part No.		Höhe Height
mit fugenlosem Griff: / one piece:		
549/010*	0,1 l	5 cm
549/025**	0,25 l	7 cm
mit angesetztem Griff: / with spot welded handle:		
549/050***	0,5 l	11 cm
549/100****	1 l	13,5 cm
549/200****	2 l	19,5 cm

* Messstriche alle 25 ml, Zahlen alle 50 ml

** Messstriche und Zahlen alle 50 ml

*** Messstriche und Zahlen alle 100 ml

**** Messstriche alle 100 ml, Zahlen alle 500 ml

* graduated every 25 ml, numbered every 50 ml

** graduated and numbered every 50 ml

*** graduated and numbered every 100 ml

**** graduated every 100 ml, numbered every 500 ml

Messbecher, zylindrisch

aus Edelstahl 18/10, mit Schüttrand, graduert,
schwere Qualität

Graduated Measure

18/10 stainless steel, graduated, heavy gauge



Art-Nr. Part No.		∅ innen ∅ Inside	Höhe Height
2625/050*	0,5 l	10 cm	9,5 cm
2625/100**	1 l	12 cm	13 cm
2625/200***	2 l	14 cm	14 cm

* Messstriche alle 1/8 l, Zahlen alle 1/4 l

** Messstriche und Zahlen alle 1/4 l

*** Messstriche und Zahlen alle 1/2 l

* graduated every 1/8 l, numbers every 1/4 l

** graduated and numbered every 1/4 l

*** graduated and numbered every 1/2 l

Messbecher, zylindrisch

aus Edelstahl 18/10, außen hochglänzend,
innen electropoliert, mit Schüttrand, innen und außen
graduert (außen mit Maßzahlen), schwere Qualität

Graduated Measure

18/10 stainless steel, outside mirror polished,
inside electropolished, graduated inside and outside,
heavy gauge



Art-Nr. Part No.		∅ dia.	Höhe Height
2620/100	1 l	11 cm	13,5 cm

Messstriche und Zahlen alle 1/4 l

graduated and numbered every 1/4 l



Art-Nr. Part No.	Höhe Height	∅ dia. cm
3077/050	0,5 l	13 cm
3077/100	1 l	15 cm
3077/150	1,5 l	16 cm
3077/200	2 l	17 cm

Messstriche alle 100 ml, Zahlen alle 200 ml
graduated every 100 ml, numbers every 200 ml



Messbecher, zylindrisch

aus Edelstahl 18/10, hochglänzend, mit Ausguss-schnaupe, innen graduert, schwere Qualität

Graduated Measure

18/10 stainless steel, mirror polished, with spout, graduated inside, heavy gauge



Art-Nr. Part No.	∅ dia. cm	Höhe Height cm
520/060*	0,7 l	10
520/130**	1,3 l	12
520/210**	2,1 l	14
520/320**	3,2 l	16
520/450***	4 l	18
520/620****	5 l	20

*Messstrich alle 50 ml, Zahlen alle 100 ml
**Messstrich alle 100 ml, Zahlen alle 200 ml
***Messstrich alle 500 ml, Zahlen alle 1000 ml
****Messstrich alle 1000 ml, Zahlen alle 5000 ml
*graduated every 50 ml, numbers every 100 ml
**graduated every 100 ml, numbers every 200 ml
***graduated every 500 ml, numbers every 1000 ml
****graduated every 1000 ml, numbers every 5000 ml



Messbecher, zylindrisch

aus Edelstahl 18/10, hochglänzend, mit Ausguss-schnaupe, innen und außen graduert, Maßzahlen innen

Graduated Measure

18/10 stainless steel, mirror polished, with spout, graduated inside and outside



Art-Nr. Part No.	∅ oben ∅ Top cm	Höhe Height cm	Stärke Thickness mm	
3078/025*	7	12	1,2	0,25 l
3078/050**	9	13,5	1,7	0,5 l
3078/100**	11,5	17	1,8	1 l
3078/200***	15	20,5	1,8	2 l
3078/300****	17	23,5	1,8	3 l
3078/500*****	20	26	1,9	5 l

* Messstriche alle 5 ml, Zahlen alle 50 ml
** Messstriche alle 10 ml, Zahlen alle 100 ml
*** Messstriche alle 20 ml, Zahlen alle 200 ml
**** Messstriche alle 50 ml, Zahlen alle 200 ml
***** Messstriche alle 100 ml, Zahlen alle 500 ml
* Graduated every 5 ml, numbers every 50 ml
** Graduated every 10 ml, numbers every 100 ml
*** Graduated every 20 ml, numbers every 200 ml
**** Graduated every 50 ml, numbers every 200 ml
***** Graduated every 100 ml, numbers every 500 ml



Messbecher

aus Polypropylen, milchig-transparent, mit geprägter Skala und blauem Skalendruck, geschlossener Griff, hitzeresistent bis +125°C, unzerbrechlich, sterilisierbar

Graduated Measure

translucent polypropylene, with blue graduations, heat resistant up to +125°C, virtually unbreakable, can be sterilised



Art-Nr. Part No.	∅ oben ∅ Top cm	Höhe Height cm	
3060/100*	11	16	1 l
3060/200**	15	20	2 l

*Messstriche alle 10 ml, Zahlen alle 100 ml
**Messstriche alle 20 ml, Zahlen alle 200 ml



Messbecher mit Deckel

aus Polypropylen, milchig-transparent, mit geprägter Skala und blauem Skalendruck, geschlossener Griff, hitzeresistent bis +125°C, Deckel lässt sich in offene/geschlossene Position drehen

Graduated Measure with Lid

translucent polypropylene, with blue graduations, lid can be turned open or closed, heat resistant up to +125°C, virtually unbreakable



Messbecher

aus klarem Polystyrol, mit offenem Griff, gedruckte mehrsprachige Skalen Liter / ccm und Zucker / Mehl

Graduated Measure

clear polystyrene, graduated every 1/4 l and in sugar and flour measures (g)



Art-Nr. Part No.	Ø dia. cm	Höhe Height cm	
3055/100	12	15	1 l

Fetttrennkanne

aus Polycarbonat, dadurch quasi unzerbrechlich für den professionellen Einsatz, zum Trennen von Bratensäften und Saucen, graduert, spülmaschinengeeignet

Fat Separator

polycarbonate, virtually unbreakable for professional use, dishwasher safe



Art-Nr. Part No.		Höhe Height cm	Ø dia. cm
6069/100	1 l	12,5 cm	11 cm

Küchenwaage

grau lackiertes Stahlgehäuse, Wägeplattform aus Edelstahl 18/0, Nutzlast bis 20 kg, skaliert in 100 g-Schritten, Auflagefläche: 23 x 23 cm

Scales

grey lacquered steel casing, 18/0 stainless steel base, max. load 20 kg, marked every 100g, top: 23x23 cm



Art-Nr. Part No.	Länge Length cm	Breite Width cm	Höhe gesamt Overall Height cm
241/020	23	25	27

Küchenwaage

grau lackiertes Stahlgehäuse, Schale aus Edelstahl, hochglänzend, Nutzlast bis 2 kg, skaliert in 10 g-Schritten, Schalenkapazität: 0,7 l

Scales

grey lacquered steel casing, bowl stainless steel, mirror polished, max. load 2 kg, marked every 10g, bowl capacity: 0.7L



Art-Nr. Part No.	Länge Length cm	Breite Width cm	Höhe gesamt Overall Height cm
242/002	14,5	20	25

Art-Nr. Part No.	∅ Durchlauf ∅ Nozzle cm	Höhe Height cm	∅ innen ∅ Inside cm	
5420/050*	0,7	6,5	4,5	0,02 l
5420/100	1,3	12	9	0,1 l
5420/120	1,3	13,5	11	0,25 l
5420/150	2,2	16,5	14	0,4 l
5420/200	2,2	20	19	1 l
5420/250	2,2	23	23	2 l

*ohne Griff, ohne Seitennut.

*without handle, straight tube.

Maßangabe Durchlauf bezieht sich auf den unteren Außendurchmesser des Stützens.

Nozzle diameter refers to the outside diameter at the bottom of the funnel's nozzle.



Trichter

aus Edelstahl 18/10, mit Seitennut zur Ableitung der Behälterluft

Funnel

18/10 stainless steel



Art-Nr. Part No.	∅ Durchlauf ∅ Nozzle cm	Höhe Height cm	∅ dia. cm	
5421/300	2,5	32,5	30	6 l
5421/400	3,5	37,5	40	15 l

Maßangabe Durchlauf bezieht sich auf den unteren Außendurchmesser des Stützens.

Nozzle diameter refers to the outside diameter at the bottom of the funnel's nozzle.



Fasstrichter

aus Edelstahl 18/10, hochglänzend, mit Griff, schwere Qualität

Funnel

18/10 stainless steel, mirror polished finish, with handle, heavy gauge



Art-Nr. Part No.	∅ Durchlauf ∅ Nozzle cm	Höhe Height cm	∅ innen ∅ Inside cm	
2670/300	10	25	29,5	8 l

Drahtständer aus Edelstahl hierzu: / Stainless steel wire stand:

2670/936 38 25,5



Sous-Vide Einfülltrichter

aus Edelstahl 18/10, zum Umfüllen von vorbereiteten Speisen in Vakuumbbeutel, die Kochbeutel bleiben im Verschlussbereich sauber

Sous Vide Funnel

18/10 stainless steel, to fill sous vide plastic bags with prepared food



Art-Nr. Part No.	∅ Durchlauf ∅ Nozzle cm	Höhe Height cm	∅ innen ∅ Inside cm	
5425/060	0,6	8	5,5	0,05 l
5425/080	0,8	10,5	7	0,08 l
5425/100	0,9	12,5	9,5	0,2 l
5425/120	1	14,5	11	0,3 l
5425/140	1,2	16,5	13	0,55 l
5425/165	1,2	19,5	15	0,8 l

Maßangabe Durchlauf bezieht sich auf den unteren Außendurchmesser des Stützens.

Nozzle diameter refers to the outside diameter at the bottom of the funnel's nozzle.



Trichter

aus weißem hochdichten Polyethylen, mit Entlüftungsrippen und Aufhängeöse, sehr stabil

Funnel

white high density polyethylene, with hanging loop, sturdy construction



Art-Nr. Part No.	∅ Durchlauf ∅ Nozzle cm	Höhe Height cm	∅ dia. cm
5428/170	1,5	20	16
5428/210	1,8	22	20



Abfülltrichter

aus weißem hochdichten Polyethylen, mit Filtereinsatz aus Edelstahlgeflecht, mit Aufhängeöse

Funnel

white high density polyethylene, stainless steel wire filter insert, with hanging loop



Einmachtrichter

aus gelbem Polypropylen, spülmaschineneeignet, zum Abfüllen von z.B. Marmeladen in Gefäße mit Öffnungen von 49, 66 und 82 mm

Funnel

yellow polypropylene, dishwasher safe, for filling jam into jars of 49, 66 and 82 mm diameters



Art-Nr. Part No.	∅ Durchlauf ∅ Nozzle cm	Höhe Height cm	∅ innen ∅ Inside cm
5427/100	4	5,5	10,5

Gewürzdose/Streuer

aus Edelstahl 18/10, hochglänzend, Deckel mit Bajonetverschluss, mit Kunststoffkappe für Aroma-, Transport- und Feuchteschutz (ausgenommen Gewürzdose 1424/005)

Shakers

18/10 stainless steel, mirror polished finish, with bayonet top, and plastic covers (except spice box 1424/005)



Art-Nr. Part No.	∅ dia. cm	Höhe Height cm
Streuer mit 1 mm Lochung: / Shaker 1 mm holes:		
1424/001	0,3 l	7
Streuer mit 2 mm Lochung: / Shaker 2 mm holes:		
1424/002	0,3 l	7
Streuer mit 4 mm Lochung: / Shaker 4 mm holes:		
1424/003	0,3 l	7
Netzstreuer: / Mesh shaker:		
1424/004	0,3 l	7
Gewürzdose: / Spice box:		
1424/005	0,3 l	7

Gewürzdose/Streuer

aus Edelstahl 18/10, hochglänzend, Deckel mit Bajonetverschluss

Shakers

18/10 stainless steel, mirror polished finish, with bayonet top



Art-Nr. Part No.	∅ dia. cm	Höhe Height cm
Streuer mit 1 mm Lochung: / Shaker 1 mm holes:		
1430/001	0,15 l	6
Streuer 2 mm Lochung: / Shaker 2 mm holes:		
1430/002	0,15 l	6
Netzstreuer: / Mesh Shaker:		
1430/004	0,15 l	6
Gewürzdose: / Spice Box:		
1430/005	0,15 l	6

Streuer mit Schraubdeckel

aus Edelstahl, hochglänzend, mit dichter 2 mm-Lochung, für Zucker, Salz, Gewürze, schwere Qualität

Shaker

stainless steel, with screw top, mirror polished finish, 2 mm holes, heavy gauge



Art-Nr. Part No.	∅ dia. cm	Höhe Height cm	
Mit Griff: / With Handle:			
1420/070	7	9,5	0,3 l
Ohne Griff: / Without Handle:			
1421/070	7	9,5	0,3 l
1421/135	7	13,5	0,45 l
1421/175	7	18,5	0,6 l



Art-Nr. Part No.	∅ dia. cm	Höhe Height cm
---------------------	-----------------	----------------------

Salzstreuer 2 mm Lochung: / Salt 2 mm holes:			
1418/070	7	9	0,3 l
1418/175	7	18,5	0,6 l

Pfefferstreuer 1 mm Lochung: / Pepper 1 mm holes:			
1419/070	7	9	0,3 l
1419/175	7	18,5	0,6 l



Salz-/Pfefferstreuer

aus Edelstahl, mit Schraubkappe, hochglänzend

Shakers

stainless steel, with screw top, mirror polished finish



Art-Nr. Part No.	∅ dia. cm	Höhe Height cm
---------------------	-----------------	----------------------

2260/080	8 cm	18,5 cm
----------	------	---------



Streuer mit Schraubdeckel

aus matt gebeiztem Aluminium, 2 mm-Lochung im Schraubdeckel, für Gewürze, Salz, Zucker usw.

Shaker

aluminium, 2 mm holes, with screw top



Art-Nr. Part No.	∅ dia. cm	Höhe Height cm
---------------------	-----------------	----------------------

Salzstreuer mit 83 Löchern: / with 83 holes:		
2262/065	6,5 cm	12 cm

Pfefferstreuer mit 26 Löchern: / with 26 holes:		
2266/065	6,5 cm	12 cm



Salz-/Pfefferstreuer

aus nahtlos verarbeitetem Aluminium, mit Schraubkappe, 2 mm Lochung

Shakers

aluminium, with screw top, 2 mm holes



Art-Nr. Part No.	∅ dia. cm	Höhe Height cm	
1434/140	7	14	0,45 l



Multi-Streuer

aus Edelstahl 18/10, hochglänzend Schraubkappe mit drei verschiedenen Lochgrößen: 6 mm, 4 mm und 1,5 mm, durch Drehmechanismus wählbar

Multi-Functional Shaker

18/10 stainless steel, mirror polished finish, screw top with three different hole sizes: 6, 4 and 1.5 mm



Art-Nr. Part No.		∅ max. cm	Höhe Height cm
---------------------	--	--------------	----------------------

mit Klappe: / with flap:			
1422/301	300 ml	7,5	14

Loch-∅ 1,5 mm: / 1,5 mm holes:			
1422/302	300 ml	7,5	14

Loch-∅ 4 mm (für Käse, Gewürze): / 4 mm holes (for cheese, spices):			
1422/304	300 ml	7,5	14



Streuer

aus glattem Pressglas, mit Schraubkappe aus Edelstahl 18/0, spülmaschinengeeignet

Shakers

clear glass with 18/0 stainless steel screw, dishwasher safe



Speisenbearbeitung

Vom Apfelnentkerner bis zum Zester – hier findet der Koch sein entsprechendes Werkzeug zur Zubereitung und Präsentation seiner Speisen. Mit modernen Kochutensilien kann Küchenarbeit so einfach sein. In dieser Kategorie finden Sie jene Hilfsmittel, die Ihnen bei der Speisearbeitung gute Dienste leisten werden.

Food Preparation

From apple corer to zester - here chefs will find the appropriate tools to facilitate the preparation and presentation of their food. With modern cooking accessories, kitchen work can be so much easier. In this category you will find all the accessories that will help you get ready for service.

Seite Page
100

Reiben, Hobel & Schneidgeräte
Graters and Mandolins

Seite Page
108

Messer 3600
3600 Knife range

Seite Page
112

Messer Megol®
Megol® Knives

Seite Page
115

Käsemesser
Cheese Knives

Seite Page
120

Messorzubehör
Knife Accessories

Seite Page
126

Fleischartbeitung
Meat Preparation

Seite Page
138

Chef Tools
Chefs Garnishing Tools

Seite Page
151

Rührbesen, Kellen & Schaufeln
Whisks, Ladles & Scoops

Seite Page
163

Servierlöffel & Gabeln
Serving Spoons & Forks

Seite Page
174

Wender & Zangen
Slices & Tongs

Seite Page
196

Polaris
Polaris

Seite Page
208

Fisch & Meer
Fish & Seafood



Reiben, Hobel & Schneidgeräte

Egal ob Sie Gemüse, Schokolade oder Gewürze raspeln, Hartkäse hobeln und Zitruschalen reiben wollen - **contacto** bietet für jeden Zweck die passenden Reiben und Hobel an.

Graters and Mandolins

Whether you want to grate vegetables, chocolate or spices, slice hard cheese or zest - **contacto** offers the right graters and slicers for every purpose.

Sechskantreibe

aus Edelstahl 18/0, hochglänzend, leichte Qualität, universell einsetzbar für Rohkost, Käse, Nüsse, Bircher Müsli, Zitruschalen

Hexagonal Box Grater

18/0 stainless steel, mirror polished finish



Art-Nr. Part No.	∅ dia.	Höhe Height
88/190	9,5 cm	19 cm

Vierkantreibe

aus Edelstahl 18/0, hochglänzend, mit extra geschärftem, eingelassenem Hobelmesser, handlicher Rohrgriff aus Edelstahl 18/10, verstärkte Vernietung, schwere Qualität

Heavy Box Grater

18/0 stainless steel, mirror polished finish, extra sharpened blade for cucumbers etc., hollow handle made of 18/10 stainless steel with reinforced rivets, heavy gauge



Art-Nr. Part No.	Länge Length	Breite Width	Höhe Height
89/240	11 cm	8,5 cm	24 cm

Vierkantreibe

aus Edelstahl 18/0, hochglänzend, in standfester, stapelbarer Dachform, für Rohkost, Käse, Nüsse usw.

Box Grater

18/0 stainless steel, mirror polished finish, stackable



Art-Nr. Part No.	Länge Length	Breite Width	Höhe Height
90/200	12 cm	9,5 cm	20 cm



Art-Nr. Part No.	Länge Length cm	Breite Width cm	Höhe Height cm
96/250	10,5	7,5	23,5



Vierkantreibe

aus Edelstahl 18/0, hochglänzend, universell einsetzbar für Rohkost, Käse, Nüsse usw.

Rectangular Box Grater

18/0 stainless steel, mirror polished finish



Art-Nr. Part No.	Länge Length cm	Breite Width cm	Höhe Height cm
206/200	20	10,5	15



Parmesanreibe

mit Auffangbehälter, aus Edelstahl 18/0, hochglänzend, mit ergonomischem Griff, zusammenklappbar, auch für Zitruschalen geeignet

Parmesan Cheese Grater

18/0 stainless steel, mirror polished finish



Art-Nr. Part No.	Fläche Size cm	Länge gesamt Total Length cm
947/235	11 x 6	23,5



Zitronen-/Parmesanreibe, extra fein

Serie POLARIS, mit seidenmatt poliertem Griff aus Edelstahl 18/10, Reibfläche aus hochglänzendem Edelstahl 18/0

Zester/Parmesan Grater

with hanging loop, handle 18/10 stainless steel, blade 18/0 stainless steel



Art-Nr. Part No.	Fläche Size cm	Länge gesamt Total Length cm
948/250	10 x 6	25



Muskatnussreibe

Serie POLARIS, mit seidenmatt poliertem Griff aus Edelstahl 18/10, Reibfläche aus hochglänzendem Edelstahl 18/0, gewölbte Form

Nut Grater

with hanging loop, handle 18/10 stainless steel, curved blade 18/0 stainless steel



Art-Nr. Part No.	Fläche Size cm	Länge gesamt Total Length cm
962/032	11,5 x 6	24



Rohkost-/Bircherreibe

Serie POLARIS, mit seidenmatt poliertem Griff aus Edelstahl 18/10, Reibfläche aus hochglänzendem Edelstahl 18/0

Vegetable Grater

with hanging loop, handle 18/10 stainless steel, blade 18/0 stainless steel



Art-Nr. Part No.	Fläche Size cm	Länge gesamt Total Length cm
991/300	10,5 x 9	30



Kartoffelreibe

Serie POLARIS, Griff aus seidenmatt poliertem Edelstahl 18/10, große Reibfläche aus hochglänzendem, geschärftem Edelstahl 18/0

Potato Grater

with hanging loop, handle 18/10 stainless steel, blade 18/0 stainless steel



Reiben

aus gehärtetem Edelstahl 18/10, 13 x 6 cm Reibfläche,
12 cm langer schwarzer Polyamid-Griff,
mit Aufhängeöse, mit Stützbügel,
hochwertige Verarbeitung, spülmaschineneeignet

Grater

hardened 18/10 stainless steel, 13 x 6 cm blade,
12 cm black polyamide handle, hanging loop, support to keep
the blade off work surface, high quality, dishwasher safe



Art-Nr. Part No.	Schneidbreite Cutting Width	
2269/011	2 mm	fein/fine
2269/006	4 mm	mittel/medium
2269/005	6 mm	grob/coarse
2269/004*	10 mm	schmaler Schnitt/narrow cut
2269/001	22 mm	Hobel/Shaver
2269/008	3 mm	fein rund/fine round
2269/009	6 mm	Kartoffelreibe/coarse round
2269/969	Resthalter / hand guard	
*schält in beide Richtungen		
*double-sided		

Arbeitshalterung für Reiben

aus Edelstahldraht, mit Einhängenhaken zum Arbeiten
über Gastronorm-Behältern, passend zu den Reiben
2269

Grater Support

stainless steel wire, with hook for fixing to Gastronorm
containers, to suit 2269 graters



Art-Nr. Part No.	Länge Length cm	Breite Width cm	Höhe Height cm
7554/145	14,5	7,5	11

Reiben, schmal

aus gehärtetem Edelstahl 18/10, 22 x 3,5 cm
feilenförmige Reibfläche, 18 cm langer schwarzer
Polyamid-Griff, mit Aufhängeöse, mit Stützbügel,
hochwertige Verarbeitung, spülmaschineneeignet

Grater

hardened 18/10 stainless steel, 22 x 3.5 cm blade,
18 cm black polyamide handle, hanging loop, support to
keep the blade off work surface, high quality,
dishwasher safe



Art-Nr. Part No.	Klingenbreite Blade Width	
2237/011	2 mm	fein/fine
2237/006	4 mm	mittel/medium
2237/005	6 mm	grob/coarse
2237/004*	10 mm	schmaler Schnitt/narrow cut
2237/007	3 mm	Parmesan/nut
2237/937	Resthalter / hand guard	
*schält in beide Richtungen		
*double-sided		



Art-Nr. Part No.	Länge Length	Breite Width
94/135	13,5 cm	5 cm



Nussreibe

aus Edelstahl 18/0, hochglänzend, besonders effektiv durch gewölbte Form, für Muskatnüsse, Mandeln, Haselnüsse usw.

Nut Grater

18/0 stainless steel, mirror polished finish, curved



Art-Nr. Part No.	Fläche Size cm	Länge gesamt Total Length cm
2267/305	20,3 x 2,5	30,5



Zesterreibe

originale Microplane® Feinreibe, aus extrem scharfen Edelstahl, ohne Verletzungsgefahr, hobelt nur das Gelbe der Zitronenschale ab, dadurch deutlich intensiverer Geschmack

Microplane® Lemon/Lime Grater

extremely sharp stainless steel, removes just surface of the fruit, intensifying the flavour



Art-Nr. Part No.	Ø dia. cm	Ø innen Ø Inside cm	Höhe Height cm
2717/175	17,5	9	3



Ingwerreibe

aus Porzellan, mit scharfer Reibfläche, speziell für Ingwer oder auch Wasabi geeignet

Grater

porcelain, especially suitable for ginger or wasabi



Art-Nr. Part No.	Ø dia. cm	Höhe Height cm
6793/090	9	9,5



Muskatnussmühle

aus Acryl, verchromter Griff, mit Edelstahlmahlwerk, Vortrieb durch Drückfeder, die Mahlkammer wird umrandet durch Vorratsbehältnis für weitere Muskatnüsse

Nutmeg Mill

acrylic, chrome plated handle, stainless steel mechanism, encased built in spring



Art-Nr. Part No.		Farbe Colour
6537/001	POTATO	braun/brown
6537/006	VEGGIE	grün/green
6537/009	CARROT	orange

Preis je Paar.
Priced and packed in pairs.



Gemüseputzhandschuhe

aus farbigem Polyamid, Einheitsgröße, waschbar bei +40°C, mit Beschriftung, das raue Material bürstet den Oberflächenschmutz ab

Food Cleaning Gloves

coloured polyamide, one size, washable at +40°C, the rough surface of the glove cleans the surface of the food



Art-Nr. Part No.	Ø innen Ø Inside cm	Höhe gesamt Overall Height cm	Länge Length cm	
244/110	11	8	17,5	0,5 l



Mörser mit Stößel

aus Edelstahl, matt gebürstet, Fuß des Mörsers aus Kunststoff, Gewicht des Stößels: 0,25 kg, schwere Qualität

Mortar and Pestle

stainless steel, satin polished, mortar base has plastic ring, pestle weight: 0.25 kg, heavy gauge



Krauthobel

Arbeitsfläche und Schlitten aus Holz, mit Klingen aus Edelstahl, zur traditionellen Herstellung von Sauerkraut u.a.

Sauerkraut Mandolin

natural wood, stainless steel blades



Art-Nr. Part No.	Länge Length cm	Breite Width cm	Schneidbreite Cutting Width cm
4470/003	60	24	20

mit drei Messern: / with three blades:

Gurkenhobel

aus naturbelassenem Holz, mit Klingen aus gehärtetem Edelstahl

Cucumber Mandolin

natural wood, hardened stainless steel blades



Art-Nr. Part No.	Länge Length cm	Breite Width cm	Schneidbreite Cutting Width cm
4472/400	37	12	8,5

Gemüsehobel

"Mandoline" aus Edelstahl 18/10, Schnittstärke justierbar, geriffelte und glatte Klinge, inkl. drei Schneideinsätze für 3 mm, 5 mm und 10 mm aus Messerstahl

Mandolin

18/10 stainless steel, fluted and smooth blade, incl. cutter set of 3 mm, 5 mm and 10 mm, easy to use and clean



Art-Nr. Part No.	Länge Length cm	Breite Width cm
4460/400	36,5	11,5

Restehalter bitte separat bestellen: / Please order hand guard separately:

4460/001	6 cm	12 cm
----------	------	-------

Ersatzmesser und -schneideinsätze auf Anfrage lieferbar.
Spare parts on request.

Gemüsehobel

"Mandoline" aus Edelstahl 18/10, ausklappbare, schwere Edelstahl-Halterungen, die in einem Spezialverfahren gummiert und vulkanisiert werden, zwei horizontale Klingen für glattes oder gewelltes Schneiden, drei senkrecht einsetzbare Klingen mit Scherkammprofil, Schnitt dickeneinstellung: 2 mm, 4 mm und 10 mm, ergonomischer Führungsschlitten, schwere Qualität

Mandolin

18/10 stainless steel, specially coated sturdy supports to prevent slipping, 2 horizontal blades (1 smooth and 1 fluted), 3 vertical fluted blades, (2, 4 and 10 mm), ergonomical hand guard, heavy gauge



Art-Nr. Part No.	Länge gesamt Total Length cm	Höhe gesamt Overall Height cm	Klingenbreite Blade Width cm
4467/470	39	24	10,5

Ersatzmesser und -schneideinsätze auf Anfrage lieferbar.
Spare parts on request.

Fadenhobel

aus Edelstahl und Aluminiumguss, mit Kunststoffkurbel, für dekorative Endlosfäden aus Möhren, Rettich u.a., inkl. 3 Schneideinsätzen für 2, 3 und 6 mm breite Streifen, zerlegbar für Reinigung

Vegetable Slicer

stainless steel and aluminium, with plastic handle. Produces long angel hair spaghetti vegetable strands, includes 2, 3 and 6 mm blades, dismantlable for cleaning



Art-Nr. Part No.	Länge Length cm	Breite Width cm	Höhe Height cm
322/001	37	14	25

Passender Auffangbehälter: GN 1/2 bis 40 mm von Seite 35.
GN 1/2 size pan (up to 40 mm) can fit underneath for juice

Art-Nr. Part No.	Länge Length cm	Breite Width cm	Höhe Height cm
572/001	48	20	28

Ersatzteile auf Anfrage.
Spare parts on request.



Tomatenschneider

ganz aus Edelstahl 18/10, für 5,5 mm breite Scheiben, zum schnellen Schneiden von Tomaten, Zitronen, Pilzen, Orangen, Kiwis u.a., spülmaschinenfest, schwere Qualität

Tomato Slicer

18/10 stainless steel, with scalloped blades, for slices 5.5 mm thick, dishwasher safe, heavy gauge



Art-Nr. Part No.	Länge Length cm	Breite Width cm	Höhe Height cm
583/011	42	18	20

583/906 Ersatzklingensatz / Spare Blades Set



Tomatenschneider

aus Aluminiumguss, Klingen aus Edelstahl, für 4 mm breite Scheiben, zerlegbar, auch für Stangeneier geeignet

Tomato Slicer

cast aluminium, stainless steel blades, cuts 4 mm slices, dismountable, frames not dishwasher safe



Art-Nr. Part No.	Länge Length cm	Breite Width cm	Schnittstärke Cutting Thickness mm
3694/012	32	17	9,5



Mozzrellaschneider

Rahmen aus Aluminiumguss, Schneiddrähte aus Edelstahl, schneidet 12 Scheiben, auch für Stangeneier geeignet, nicht spülmaschinengeeignet

Mozzarella Slicer

cast aluminium frame, with stainless steel wires, cuts 12 slices, also suitable for boiled eggs, not dishwasher safe



Art-Nr. Part No.	Länge Length cm	Breite Width cm	Höhe Height cm	Segmente Portions
581/008	20	25	40	8

581/901 Apfelschneideinsatz 8 Seg. /
8 wedge apple cutter

581/911 Drücker zu Apfelschneideinsatz /
Pusher for Apple Cutter

581/906 Sechstel-Schneide-Einsatz /
6 wedge cutter

581/916 Drücker zu Sechstel-Schneider /
Pusher for 6 wedge cutter

581/908 Achtel-Schneide-Einsatz /
Eight segment cutter

581/918 Drücker zu Achtel-Schneideinsatz /
Pusher for 8 wedge Cutter

Lieferung mit einem Schneideinsatz für 8 Segmente.
Shipped with one 8 segment cutter.



Apfel-/Limettenschneider

aus Aluminiumguss, mittelschwere Ausführung, Schneidmesser aus Edelstahl, mit Gummifüßen, schneidet perfekte Stücke aus Limetten, Zitronen oder anderen Früchten, optional auch für Äpfel

Citrus Wedger

cast aluminium, medium gauge, stainless steel blades, complete with 8 wedge stainless steel cutter, rubber feet, cuts perfect wedges of lemons, limes or other citrus fruit, with option for apples



Schneideapparat

aus Edelstahl 18/10, Drücker aus Polyethylen, Schneideinsatz 8 x 8 mm, 20,5 cm Nutzhöhe, zum Zuschneiden von quadratischen Gemüsestreifen, spülmaschinengeeignet, schwere Qualität

Dicer

18/10 stainless steel, polyethylene pusher, 8 x 8 mm blades, 20.5 cm working height, dishwasher safe, heavy gauge



Art-Nr. Part No.	Länge Length cm	Breite Width cm	Höhe Height cm
327/008	35,5	26	66
327/810	Drücker 10x10mm / Extra pusher 10x10mm		
327/910	Schneideinsatz 10x10mm / Extra cutter 10x10mm		

Salatschneidegerät

aus Edelstahl 18/10, mit 23 x 23 mm Schneideeinsätzen, zerschneidet Salatköpfe mit einem Hub, schwere Qualität

Iceberg Lettuce Cutter

18/10 stainless steel, 23 x 23 mm blades, cuts with one stroke, heavy gauge



Art-Nr. Part No.	Länge Length cm	Breite Width cm	Höhe Height cm
571/023	42	30	70

Ersatzteile auf Anfrage.
Spare parts on request.

Pommes frites-Schneider

ganz aus Edelstahl 18/10 (auch Bodenplatte), auswechselbare Schneideinsätze aus gehärtetem Messer Stahl, spülmaschinenfest, 4 bis 5 kg Durchsatz in der Minute

Potato Chipper

all 18/10 stainless steel, interchangeable blades and pusher, on stainless steel weighted table stand, dishwasher safe, flow rate per minute: 4 to 5 kg, heavy gauge



Art-Nr. Part No.	Länge Length cm	Breite Width cm	Höhe Height cm
Grundmodell ohne Schneideinsätze: / Base model without cutter:			
325/001	44	25	33,5
325/906	Schneideinsatz 6 mm / Blade 6 mm		
325/908	Schneideinsatz 8 mm / Blade 8 mm		
325/910	Schneideinsatz 10 mm / Blade 10 mm		
325/913	Schneideinsatz 13 mm / Blade 13 mm		
325/920*	für 10x20 mm / Blade 10x20 mm		
325/960*	für 6 Segmente / for 6 segments		

* /920 und /960 sind verzinkt.
* /920 and /960 are tinned.

Alle Schneideinsätze werden komplett mit dem passenden Drücker geliefert. Ersatzteile auf Anfrage.
All blades include the matching pusher. Powder coated version or spare parts on request.

Pommes châteaux-Schneider

aus Edelstahl 18/10, zum Zuschneiden von 4-8 cm langen Schlosskartoffeln, Pommes cocotte und Pommes fondantes, verschiedene Einstellungsmöglichkeiten

Potato Preparation Cutter

18/10 stainless steel, for preparing château, cocotte and fondant potatoes and other vegetables of 4-8 cm long, with 7 regular sides, adjustable blade



Art-Nr. Part No.	Länge Length cm	Breite Width cm	Höhe Height cm
576/001	31	17	19

Ersatzteile auf Anfrage.
Spare parts on request.

Art-Nr. Part No.	Länge Length cm	Breite Width cm	Höhe Height cm
573/340	31,5	12,5	21

Ersatzteile auf Anfrage.
Spare parts on request.



Apfelschäl- und schneidegerät

aus beschichtetem Aluminiumguss, zum gleichmäßigem Schälen, Entkernen und Schneiden von Äpfeln (oder Zitrusfrüchten) in einem Arbeitsgang, Edelstahlklemme zur Tischbefestigung, schwere Profiqualität

Apple Peeler, Slicer and Corer

coated cast aluminium, for table mounting with clamp, for professional use



Art-Nr. Part No.	Länge Length cm	Breite Width cm	Höhe Height cm
578/001	10,5	8	24



Pflaumen- und Kirschenentsteiner

aus beschichtetem Aluminiumdruckguss, Stöbel aus ABS-Kunststoff, Messer aus Edelstahl

Plum and Cherry Stoner

cast aluminium, ABS plastic handle, stainless steel blades



Art-Nr. Part No.	Länge Length cm	Breite Width cm	Schnittstärke Cutting Thickness mm
574/230	44	22,5	10 - 85



Brotschneidegerät

Gestell aus Buchenholz, Sägeblatt aus Messerstahl, mit einstellbarer Schnittstärke, Griffschutz zur sicheren Handhabung, saubere Schnittergebnisse, mühelose Bedienung

Bread Slicer

beechwood base, adjustable stainless steel blade, transparent hand guard, slices precisely, easy to use



Art-Nr. Part No.	Länge Length cm	Breite Width cm	Höhe Height cm

PRODUKTION
EINGESTELLT
PRODUCTION
DISCONTINUED



Wurstschneidegerät

Gestell aus Buchenholz, Säge aus Klingenstahl, Griffschutz zur sicheren Bedienung, gute Schnittergebnisse durch leichte Aufwärtsbewegung des Schiebers, die Schnittstärke ist individuell einstellbar, Klinge ist in sicherer Position feststellbar, nicht spülmaschinengeeignet

Sausage Slicer

beechwood frame, adjustable stainless steel blade, with hand guard, slices precisely, not dishwasher safe



Art-Nr. Part No.	Länge Length cm	Breite Width cm	Höhe Height cm

PRODUKTION
EINGESTELLT
PRODUCTION
DISCONTINUED



Currywurstschneider, manuell

aus Edelstahl, zehn Sägeklingen aus Messerstahl für 18 mm breiten Schnitt an maximal 20 cm langen Würsten, Abstandhalter aus Polypropylen, Wurstscheiben fallen nach unten weg, Drückplatte aus Aluminium, daher ohne vorheriges Zerlegen nicht spülmaschinenfest, mit 4 Saugfüßen

Sausage Slicer

stainless steel, with aluminium basket, 10 stainless steel blades and 4 non slip feet, slices a 20 cm sausage into 11 portions 18 mm thick, not dishwasher safe without removal of aluminium basket





Messer 3600

Solinger Spitzenqualität mit vernieteten und verschweißten POM-Kunststoff Griffen und Klingen aus Chrom-Molybdän-Vanadium-Stahl, die aus einem Stück geschmiedet werden.

3600 Knife range

Top quality professional German knives from Solingen one piece forged molybdenum vanadium stainless steel blades with riveted and welded POM handles.

Die Griffe aus POM-Kunststoff sind vernietet und verschweiß, damit keine Hohlräume entstehen. Sie sind absolut hygienisch sauber mit der Klinge verbunden.

Die geschmiedeten Klingen sind aus Chrom-Molybdän-Vanadium-Stahl (Werkstoff 1.4116, bzw. DIN x50CrMoV15) mit HRC 56 Härtegrad.

Made of high grade Molybdenum Vanadium stainless steel with a blade hardness of 56 HRC (Rockwell), these knives are highly corrosion resistant, with one piece drop forged blades, which are precision taper-ground, with riveted black POM handles.



Solingen

- Solinger Spitzenqualität
- geschmiedete Griffe mit POM-Griffen
- schwere Profiqualität
- Messerhärte 56 HRC
- made in Solingen
- long lasting cutting edge
- very well balanced and comfortable
- superb quality

Kochmesser

die Klingen sind zur Schneide hin besonders dünn geschliffen; daher nur zum Schneiden und nicht zum Hacken verwenden

Cooks Knife

the blades are ground particularly thin towards the cutting edge; therefore only use for cutting and not for chopping



Art-Nr. Part No.	Klingenlänge Blade cm	Klingenlänge Blade Zoll	Länge gesamt Total Length cm
3600/150	15,5	6"	28
3600/200	21	8¼"	34
3600/250	25,5	10"	39
3600/300	31	12¼"	45

Santokumesser

in der Form der japanischen Santokumesser, universell einsetzbar, mit Kullenschliff, gut nachschleifbar

Santoku Knife



Art-Nr. Part No.	Klingenlänge Blade Length cm	Klingenlänge Blade Length Zoll	Länge Length cm
3614/180	18	7"	30
Ausführung mit Wellenschliff für Schnittgut mit harter Außenschale / Scalloped to minimise food sticking to the blade			
3614/181	18	7"	30

Fischfiliermesser

durch die flexible Klinge lassen sich Haut und Gräten sauber von Fleisch und Fisch ablösen

Filleting Knife



Art-Nr. Part No.	Klingenlänge Blade cm	Klingenlänge Blade Zoll	Länge gesamt Total Length cm
3638/170	17,5	7"	30

Schinkenmesser

mit Wellenschliff, besonders für das Tranchieren von Braten mit fester Kruste

Slicer/Carving Knife

serrated



Art-Nr. Part No.	Klingenlänge Blade cm	Klingenlänge Blade Zoll	Länge gesamt Total Length cm
3618/210	21	8½"	33
3618/260	26,5	10½"	38

Art-Nr. Part No.	Klingenlänge Blade cm	Klingenlänge Blade Zoll	Länge gesamt Total Length cm
3640/130	13	5¼"	25
3640/160	15	6"	27



Ausbeinmesser

zum gezielten Herauslösen von Knochen, Fett und Sehnen

Boning Knife

Art-Nr. Part No.	Klingenlänge Blade cm	Klingenlänge Blade Zoll	Länge gesamt Total Length cm
3617/190	19	7½"	31



Fleischmesser

Carving Knife

Art-Nr. Part No.	Klingenlänge Blade cm	Klingenlänge Blade Zoll	Länge gesamt Total Length cm
3612/200	20,5	8"	33
3612/220	22	9"	35,5
3612/260	25,5	10"	38



Tranchiermesser

leichtes Tranchieren durch dünne Klinge und glatte Schneide

Slicer/Carving Knife

Art-Nr. Part No.	Zinkenlänge Prongs Length cm	Zoll	Länge gesamt Total Length cm
3604/150	12	5"	28
3604/170	14,5	6"	30,5



Tranchiergabel

mit geraden Zinken

Fork

with straight prongs

Art-Nr. Part No.	2-teiliges Set / Set of knife and fork		
3630/002			



Tranchiergarnitur

Set bestehend aus Tranchiergabel 3604/150 und Tranchiermesser 3612/200

Carving Set

3604/150 and 3612/200

Art-Nr. Part No.	Zinkenlänge Prongs Length cm	Zoll	Länge gesamt Total Length cm
3605/150	9	6"	28
3605/200	9	8"	32



Fleischgabel

mit gebogenen Zinken, ideal auch zum Wenden von Bratgut in der Pfanne

Fork

with curved prongs

Art-Nr. Part No.	Klingenlänge Blade cm	Klingenlänge Blade Zoll	Länge gesamt Total Length cm
3616/320	32	12"	43,5



Lachsmesser

extra lange, dünne Klinge zum fachgerechten Filetieren von Lachs

Salmon Knife

flexible

Art-Nr. Part No.	Klingenlänge Blade cm	Klingenlänge Blade Length Zoll	Klingenbreite Blade Width cm
3686/400	40	16"	2,9



Gyros- /Kebabmesser

Kebab Knife

Art-Nr. Part No.	Klingenlänge Blade Length cm	Klingenlänge Blade Length Zoll	Klingenbreite Blade Width cm
3687/400	40	16"	2,9



Wurstmesser

mit Wellenschliff

Sausage Knife

serrated

Schäl- /Tourniermesser

kurzes Messer in Vogelschnabelform zum genauen Schneiden entlang runder Formen, eignet sich besonders zum Schälen, Entkernen und Verzieren von Früchten oder Gemüse



Art-Nr. Part No.	Klingenlänge Blade cm	Klingenlänge Blade Zoll	Länge gesamt Total Length cm
3626/070	7	2¾"	18

Peeling/Turning Knife

Gemüsemesser

Paring Knife



Art-Nr. Part No.	Klingenlänge Blade cm	Klingenlänge Blade Zoll	Länge gesamt Total Length cm
3601/090	9	3½"	20

Spick- / Officemesser

ideal zum Schneiden, Schälen und Verzieren

Vegetable/Utility Knife



Art-Nr. Part No.	Klingenlänge Blade cm	Klingenlänge Blade Zoll	Länge gesamt Total Length cm
3602/090	8,5	3½"	19
3602/100	10	4"	21
3602/120	11,5	4½"	22,5

Tomaten- / Käsemesser mit Wellenschliff

schneidet Tomaten ohne diese zu zerquetschen, leichte Aufnahme von Tomaten und Käsescheiben mit den zwei vorderen Zinken



Art-Nr. Part No.	Klingenlänge Blade cm	Klingenlänge Blade Zoll	Länge gesamt Total Length cm
3627/130	12,5	5"	23

Tomato Knife

serrated

Buntschneidemesser

zur Herstellung von dekorativen Riffelscheiben aus Obst, Gemüse, Käse oder Butter



Art-Nr. Part No.	Klingenlänge Blade cm	Klingenlänge Blade Zoll	Länge gesamt Total Length cm
3615/110	10,5	4"	21

Garnishing/Decorating Knife

Buntschneidemesser

zur Herstellung von dekorativen Riffelscheiben aus Obst, Gemüse, Käse oder Butter



Art-Nr. Part No.	Klingenlänge Blade Length cm	Klingenlänge Blade Length Zoll	Länge gesamt Total Length cm
2230/100	10	4"	20

Garnishing/Decorating Knife

Brotmesser mit Wellenschliff

durch den Wellenschliff lässt sich die Brotkruste leicht durchschneiden und es ergeben sich ebenmäßige Scheiben



Art-Nr. Part No.	Klingenlänge Blade cm	Klingenlänge Blade Zoll	Länge gesamt Total Length cm
3620/200	20,5	8"	33

Bread Knife

serrated

Universalmesser mit Wellenschliff

durch den Wellenschliff lässt sich die Brotkruste leicht durchschneiden und es ergeben sich ebenmäßige Scheiben. Besonders im Selbstbedienungsbereich für Baguettebrote o.ä. geeignet



Art-Nr. Part No.	Klingenlänge Blade Length cm	Klingenlänge Blade Length Zoll	Länge Length cm
3635/260	26	10"	39

Utility / Bread Knife

serrated

Brötchenmesser

der feine Wellenschliff durchsäht leicht die knusprige Brötchenkruste



Art-Nr. Part No.	Klingenlänge Blade cm	Klingenlänge Blade Zoll	Länge gesamt Total Length cm
3636/130	13	5¼"	23

Sandwich Knife

serrated

Art-Nr. Part No.	Klingenlänge Blade cm	Klingenlänge Blade Zoll	Länge gesamt Total Length cm
4600/150	15	6"	28
4600/200	20	8"	32,5
4600/250	25	10"	38
4600/300	30	12"	43



Kochmesser

die Klingen sind zur Schneide hin besonders dünn geschliffen; daher nur zum Schneiden und nicht zum Hacken verwenden

Cooks Knife

the blades are ground particularly thin towards the cutting edge; therefore only use for cutting and not for chopping

Art-Nr. Part No.	Klingenlänge Blade cm	Klingenlänge Blade Zoll	Länge gesamt Total Length cm
4603/210	21	8¼"	33



Brotmesser mit Wellenschliff

durch den Wellenschliff lässt sich die Brotkruste leicht durchschneiden und es ergeben sich ebenmäßige Scheiben

Bread Knife

serrated

Art-Nr. Part No.	Klingenlänge Blade cm	Klingenlänge Blade Zoll	Länge gesamt Total Length cm
4607/150	15	6"	27,5



Ausbeinmesser

zum gezielten Herauslösen von Knochen, Fett und Sehnen

Boning Knife

Art-Nr. Part No.	Klingenlänge Blade cm	Klingenlänge Blade Zoll	Länge gesamt Total Length cm
4605/150	15	6"	28
4605/200	20	8"	32,5
4605/250	25	10"	38



Tranchiermesser

leichtes Tranchieren durch dünne Klinge und glatte Schneide

Slicer/Carving Knife

Art-Nr. Part No.	Zinkenlänge Prongs Length cm	Zoll	Länge gesamt Total Length cm
4604/150	17	6"	28,5



Tranchiergabel

mit geraden Zinken

Fork

with straight prongs

Art-Nr. Part No.	Klingenlänge Blade cm	Klingenlänge Blade Zoll	Länge gesamt Total Length cm
4602/090	9	3½"	19,5
4602/115	11,5	4½"	23



Spick-/ Officemesser

ideal zum Schneiden, Schälen und Verzieren

Vegetable/Utility Knife

Art-Nr. Part No.	Klingenlänge Blade cm	Klingenlänge Blade Zoll	Länge gesamt Total Length cm
4606/075	7,5	3"	18



Schälmesser

Peeling/Turning Knife

Messer Megol®

Die **contacto** Messerserie mit dem hartem Megol-Kunststoff-Griff ist temperaturbeständig, spülmaschinengeeignet und überzeugt durch ihre robuste Profiqualität.

Megol® Knives

*This **contacto** knife range with its tough Megol moulded plastic handle is temperature resistant, dishwasher safe and convinces with its robust professional quality.*

Robuste Profiqualität.

Die Griffe aus lebensmittelgeeignetem hartem Megol-Kunststoff sind temperaturbeständig von -20°C bis +120°C und spülmaschinenfest.

Die Klingen sind aus Chrom-Molybdän-Vanadium (x50CrMoV15) gefertigt.

Sturdy professional quality.

Handles are made of very strong, black moulded Megol® plastic (special high density polyethylene) and are temperature resistant from -20°C to +120°C. Dishwasher proof.

Blades are made of Molybdenum Vanadium stainless steel.



- Spitzenqualität
- Chrom-Molybdän-Vanadium-Klingen
- Griffe aus Megol
- Messerhärte 52 HRC

- high quality
- Molybdenum Vanadium Blades
- ergonomic handles
- 52 HRC blade hardness

Kochmesser

Cooks Knife, Broad



Art-Nr. Part No.	Klingenlänge Blade cm	Klingenlänge Blade Zoll	Länge gesamt Total Length cm
6032/250	25	10"	38
6032/300	30	11¾"	43

Küchenmesser

Butchers Knife



Art-Nr. Part No.	Klingenlänge Blade cm	Klingenlänge Blade Zoll	Länge gesamt Total Length cm
6031/160	16	6½"	29
6031/180	18	7"	31
6031/200	20	8"	33
6031/220	22	9"	35
6031/260	26	10½"	39

Schinkenmesser mit Kullenschliff

mit flexibler Klinge

Scalloped Slicer

flexible



Art-Nr. Part No.	Klingenlänge Blade cm	Klingenlänge Blade Zoll	Länge gesamt Total Length cm
6033/300	30	11¾"	43

Schinkenmesser

mit flexibler Klinge

Slicer

flexible



Art-Nr. Part No.	Klingenlänge Blade cm	Klingenlänge Blade Zoll	Länge gesamt Total Length cm
6034/360	36	14"	49

Schinkenmesser

mit Wellenschliff

Ham Knife

wavy edge



Art-Nr. Part No.	Klingenlänge Blade Length cm	Klingenlänge Blade Length Zoll	Länge gesamt Total Length cm
6029/300	30	11¾"	43



Art-Nr. Part No.	Klingenlänge Blade cm	Klingenlänge Blade Zoll	Länge gesamt Total Length cm
6030/140	14	5½"	27
6030/160	16	6½"	29



Ausbeinmesser
Boning Knife

Art-Nr. Part No.	Klingenlänge Blade cm	Klingenlänge Blade Zoll	Länge gesamt Total Length cm
6028/160	16	6"	29
6028/180	18	7"	31



Fleischmesser
Utility Knife

Art-Nr. Part No.	Klingenlänge Blade cm	Klingenlänge Blade Zoll	Länge gesamt Total Length cm
6042/260	26	10"	39



Blockmesser
Butchers/Steak Knife

Art-Nr. Part No.	Klingenlänge Blade cm	Klingenlänge Blade Zoll	Länge gesamt Total Length cm
6035/140	14	5½"	27
6035/200	20	8"	33



Spickmesser
Cooks Knife

Art-Nr. Part No.	Klingenlänge Blade cm	Klingenlänge Blade Zoll	Länge gesamt Total Length cm
6036/220	22	9"	35



Brotmesser mit Wellenschliff
Klinge aus Chrom-Molybdän-Vanadium (x50CrMoV15), Griff aus Polypropylen, spülmaschinengeeignet
Bread Knife
serrated edge, chrome-molybdenum-vanadium (x50CrMoV15) blade, black polypropylene handle, dishwasher safe

Art-Nr. Part No.	Klingenlänge Blade cm	Klingenlänge Blade Zoll	Länge gesamt Total Length cm
6037/070	7	2¾"	18



Gemüsemesser
Klinge aus Chrom-Molybdän-Vanadium (x50CrMoV15), Griff aus Polypropylen, spülmaschinengeeignet
Paring Knife
chrome-molybdenum-vanadium (x50CrMoV15) blade, black polypropylene handle, dishwasher safe

Art-Nr. Part No.	Klingenlänge Blade cm	Klingenlänge Blade Zoll	Länge gesamt Total Length cm
6038/100	10	4"	21



Spick-/ Officemesser
Klinge aus Chrom-Molybdän-Vanadium (x50CrMoV15), Griff aus Polypropylen, spülmaschinengeeignet
Vegetable/Utility Knife
chrome-molybdenum-vanadium (x50CrMoV15) blade, black polypropylene handle, dishwasher safe

Art-Nr. Part No.	Zinkenlänge Prongs Length cm	Zoll	Länge gesamt Total Length cm
6039/170	10	4"	27,5



Fleischgabel
aus Chrom-Molybdän-Vanadium (x50CrMoV15), Griff aus Polypropylen, spülmaschinengeeignet
Fork
chrome-molybdenum-vanadium (x50CrMoV15) blade, black polypropylene handle, dishwasher safe

Brötchenmesser, gezahnt

aus Edelstahl 18/0, starker Wellenschliff, mit rotem Kunststoffgriff, leichte, stabile Qualität

Wavy Edge Knife

18/0 stainless steel serrated blade and red plastic handle



Art-Nr. Part No.	Klingenlänge Blade cm	Klingenlänge Blade Zoll	Länge gesamt Total Length cm
3603/090	8,5	3 1/2"	17,5

Küchenmesser, glatt

aus Edelstahl 18/0, mit handlichen Kunststoffgriff

Paring Knife

18/0 stainless steel blade, with plastic handle



Art-Nr. Part No.	Klingenlänge Blade cm	Klingenlänge Blade Zoll	Länge gesamt Total Length cm	Farbe Colour
3606/070	7	2 3/4"	16	rot/red
3606/073	7	2 3/4"	16	blau/blue
3606/076	7	2 3/4"	16	grün/green

Küchenmesser, glatt

Serie POLARIS, mit ovalem Griff aus Edelstahl 18/10, Klinge aus Edelstahl 18/0

Paring Knife

with oval handle, 18/10 stainless steel, blade 18/0 stainless steel



Art-Nr. Part No.	Klingenlänge Blade Length cm	Länge gesamt Total Length cm
954/190	7	19

Tranchiermesser

leichtes Tranchieren durch dünne Klinge und glatte Schneide

Slicer/Carving Knife



Art-Nr. Part No.	Klingenlänge Blade cm	Klingenlänge Blade Zoll	Länge gesamt Total Length cm
3612/200	20,5	8"	33
3612/220	22	9"	35,5
3612/260	25,5	10"	38

Tranchiergabel

mit geraden Zinken

Fork

with straight prongs



Art-Nr. Part No.	Zinkenlänge Prongs Length cm	Länge gesamt Total Length cm
3604/150	12	28
3604/170	14,5	30,5

Tranchiermesser

mit Wellenschliff

Carving Knife

with serrated edge



Art-Nr. Part No.	Klingenlänge Blade cm	Klingenlänge Blade Zoll	Länge gesamt Total Length cm
7782/310	20	8"	31

Tranchiergabel

Fork



Art-Nr. Part No.	Zinkenlänge Prongs Length cm	Länge gesamt Total Length cm
7781/320	8 cm	32 cm

Schinkenhalter

aus Edelstahl 18/10 und 18/0, matt poliert, mit edler lackierter Holzplatte, Griffe aus Edelholz, hochwertige Verarbeitung, schwere Qualität, speziell für knochenlose Schinken

Ham Clamping Stand

18/10 and 18/0 stainless steel, matt polished finish, with vanished wooden base, high quality and heavy gauge, ideal for boneless ham



Art-Nr. Part No.	Fläche Size cm	Höhe gesamt Overall Height cm
1094/003	45 x 24	15



Käsemesser

Die Käsemesser sprechen durch ihre attraktive Optik an. Ihr praktischer Nutzen für das Schneiden und Teilen von Brie über Gorgonzola bis zu Parmesan wird jeden Käseliebhaber überzeugen

Cheese Knives

These cheese knives are not only attractive. Their practicality for cutting, slicing and dividing everything from brie to parmesan will convince every cheese gourmet.

Art-Nr. Part No.	Klingenlänge Blade cm	Klingenlänge Blade Zoll	Länge gesamt Total Length cm
3633/140	14	5½"	25



Käsemesser

mit feinem Sägeschliff, geschmiedete Klinge, Messerhärte 56 HRC, vernieteter und verschweißter Griff aus POM-Kunststoff, spülmaschinengeeignet, schwere Profiqualität, die Lochung verhindert das Festkleben der Käsescheiben an der Klinge, leichtes Aufnehmen der Scheiben durch zwei Zinken

Cheese Knife

high grade stainless steel, one piece drop forged blade 56 HRC (Rockwell), bolster and tang, with black POM handle, professional quality, finely serrated, the perforation prevents cheese from adhering to the blade



Art-Nr. Part No.	Klingenbreite Blade Width cm	Klingenlänge Blade Length cm	Länge gesamt Total Length cm
950/250	2,5	15,5	27



Käsemesser

Serie POLARIS, Klinge aus 1,5 mm Edelstahl 18/0, mit ovalem Griff aus Edelstahl 18/10, die Lochung verhindert das Festkleben der Käsescheiben an der Klinge, die Zinken ermöglichen das Aufnehmen der Scheiben

Cheese Knife

with hanging loop, oval handle, 18/10 stainless steel, serrated, blade 18/0 stainless steel, the perforation prevents cheese from adhering to the blade



Art-Nr. Part No.	Klingenlänge Blade Length cm	Länge gesamt Total Length cm
955/225	8	22,5



Käsemesser

Serie POLARIS, mit ovalem Edelstahl-Griff 18/10, glatte Klinge aus hochglänzendem Edelstahl 18/0

Cheese Knife

with oval handle, 18/10 stainless steel, blade 18/0 stainless steel



Weichkäsemesser

Klinge aus X65CrMoV15-Stahl, mit schwarzem hochdichten Griff aus Polyethylen

Soft Cheese Knife

molybdenum vanadium stainless steel, with black polyethylene handle, dishwasher safe



Art-Nr. Part No.	Klingenlänge Blade Length cm	Klingenbreite Blade Width cm	Länge gesamt Total Length cm
3682/200	20	0,6	32

Käsemesser

geschmiedete Klinge aus Chrom-Molybdän-Vanadium (DIN x50CrMoV15), vernieteter und verschweißter Griff aus POM-Kunststoff, Messerhärte 56 HRC, spülmaschineneeignet, schwere Profiqualität, die dekorative Ätzung verhindert das Festkleben der Käsescheiben an der Klinge.

Cheese Knife

fully drop forged molybdenum vanadium stainless steel, with POM handle, dishwasher safe, the etching prevents cheese from adhering to the blade



Art-Nr. Part No.	Klingenlänge Blade Length cm	Klingenlänge Blade Length Zoll	Klingenbreite Blade Width cm
3690/310	30	11½"	3,5

Käsemesser

geschmiedete Klinge aus Chrom-Molybdän-Vanadium (DIN x50CrMoV15), vernieteter und verschweißter Griff aus POM-Kunststoff, Messerhärte 56 HRC, spülmaschineneeignet, schwere Profiqualität, die dekorative Ätzung verhindert das Festkleben der Käsescheiben an der Klinge.

Cheese Knife

fully drop forged molybdenum vanadium stainless steel, with two POM handles, dishwasher safe, the etching prevents cheese from adhering to the blade



Art-Nr. Part No.	Klingenlänge Blade Length cm	Klingenlänge Blade Length Zoll	Klingenbreite Blade Width cm
3680/320	32,5	14"	3,5

Aufstrichmesser

aus flexiblem Edelstahl 18/0, hochglänzend, mit Griff aus schwarzem Polypropylen, mit glatter Klinge, zum gleichmäßigen Aufstreichen von Butter, Streichwurst oder -käse usw.

Sandwich Knife

18/0 stainless steel, mirror polished finish, flexible blade, black polypropylene handle



Art-Nr. Part No.	Spatelmaß Blade cm	Länge gesamt Total Length cm
4077/230	11,5 x 3,5	21

Art-Nr. Part No.	Länge Length	Klingenlänge Blade Length
2255/100	19 cm	10 cm



Parmesanmesser

aus X65CrMoV15-Stahl, seidenmatt poliert, mit schwarzem hochdichten Polyethylen-Griff, extra schwere Qualität, zum Brechen und Spalten des Käses

Parmesan Knife

molybdenum vanadium stainless steel, satin polished finish, black high density polyethylene handle, heavy gauge



Art-Nr. Part No.	Länge Length	Klingenlänge Blade Length
3684/150	23 cm	15 cm



Parmesanmesser

zum Aufbrechen und Teilen des Käselais, zweischneidiger Klinge aus X65CrMoV15-Stahl, seidenmatt poliert, mit schwarzem hochdichten Griff aus Polyethylen, extra schwere Qualität

Parmesan Knife

to break and divide parmesan and other hard cheeses, molybdenum vanadium stainless steel, satin polished finish, with black polyethylene handle, heavy gauge, sharpened along both edges



Art-Nr. Part No.	Länge Length	Klingenlänge Blade Length
3683/090	16 cm	9 cm



Parmesanmesser

Sichelform zum Einkerbten und Ausschaben des Käselais, einschneidige Klinge aus X65CrMoV15-Stahl, seidenmatt poliert, mit schwarzem hochdichten Griff aus Polyethylen, extra schwere Qualität

Parmesan Knife

sickle shaped to cut into and score parmesan and other hard cheeses, molybdenum vanadium stainless steel, satin polished finish, with black polyethylene handle, heavy gauge, sharpened along one edge



Art-Nr. Part No.	Länge Length	Klingenlänge Blade Length	Klingenbreite Blade Width
3685/150	23 cm	15 cm	6 - 7,5 cm



Parmesanmesser

rechteckige Form zum Schaben und Schneiden des Käselais, beidseitig schneidende Klinge aus X65CrMoV15-Stahl, seidenmatt poliert, mit schwarzem hochdichten Griff aus Polyethylen, extra schwere Qualität

Parmesan Knife

raclette knife to score and cut parmesan and other hard cheeses, molybdenum vanadium stainless steel, satin polished finish, with black polyethylene handle, heavy gauge, sharpened along both edges



Art-Nr. Part No.	Länge gesamt Total Length	Klingenlänge Blade Length
	cm	cm

PRODUKTION
EINGESTELLT
PRODUCTION
DISCONTINUED



Käsemesser Set, 5-teilig

aus Chrom-Molybdän-Vanadium-Klingenstahl, mit hellen Buchenholzgriffen, ideal für Käse-Buffets, hochwertige Qualität

Cheese Knife Set

high grade molybdenum vanadium stainless steel, mirror polished finish, with pale wood handles, heavy gauge



Käseschneidegerät

weißes Melamingehäuse, hygienisch und einfach zu nutzen, der Draht schneidet alle Arten von Käse, nach jedem Schnitt läuft der Draht in die Ausgangsposition zurück, schneller Austausch des Drahtes, für Käsestücke bis maximal 23 x 28 cm

Handee Cheese Cutter

white melamine frame, hygienic and food safe, wire slices smoothly through all types of cheeses, supplied complete with pack of 1 dozen spare 60 cm wires, other spares and stainless steel version available on request



Art-Nr. Part No.	Länge Length cm	Breite Width cm	Höhe Height cm
3692/001	40	28	10

Käseschneidedraht

mit zwei Griffen 140 x 19 mm aus weißem Polyethylen, Draht aus 0,6 mm Edelstahl, zum Schneiden von Käserädern

Cheese Wire

with two white polyethylene handles 140 x 19 mm, 0.6 mm stainless steel wire, for cutting large cheese wheels



Art-Nr. Part No.	Länge Length m
3698/002	1,2

3699/901 Weitere Ersatzdrähte (5 Stück) zu /
Further spare wires (set of 5)

Lieferung mit 4 Ersatzdrähten.
Supplied with 4 spare wires.

Käseschneidedraht

mit einem Griff 150 x 25 mm aus weißem Polyethylen, Draht aus 0,6 mm Edelstahl, zum Schneiden von Käserädern

Cheese Wire

with one white polyethylene handle 150 x 25 mm, 0.6 mm stainless steel wire, for cutting large cheese wheels



Art-Nr. Part No.	Länge Length m
3699/120	1,2

3699/901 Weitere Ersatzdrähte (5 Stück) /
Further spare wires (set of 5)

Lieferung mit 4 Ersatzdrähten.
Supplied with 4 spare wires.

Mönchskopfkäsehobel

aus hochdichtem, grob schwarz-weiß marmorierten Polyethylen, hygienisch und geruchsneutral, Hobel ganz aus Edelstahl 18/0, ergonomischer Drehgriff, spülmaschinenfest, zum dekorativen Hobeln von Mönchskopfkäse (Tête-de-Moine) oder Choco Rolles-Schokolade

Tête-de-Moine Cheese Slicer

high density polyethylene, with stainless steel blade, easy to use turning handle, hygienic, dishwasher safe, can also be used for shaving chocolate



Art-Nr. Part No.	∅ dia. cm	Höhe Height cm
3666/220	22	16

Passende Abdeckhaube aus klarem Polystyrol von Seite 303 (hierfür ohne Griffknopf zu verwenden); / Clear polystyrene cover see page 303 (use without knob herefore):

3689/200	18	13
----------	----	----

Weichkäsehobel

aus Edelstahl 18/10, mit Griff aus schwarzem Polyethylen

Soft Cheese Slicer

18/10 stainless steel, with black polyethylene handle



Art-Nr. Part No.	Länge Length cm	Schneidbreite Cutting Width cm
3732/170	17	5,5

Art-Nr. Part No.	Länge Length cm	Klingenbreite Blade Width cm	Höhe gesamt Overall Height cm
743/150	16	6	11,5



Einhand-Wiegemesser

einschneidig, aus 1,2 mm starkem Edelstahl 18/0, seidenmatt gebürstet, mit handlichem Hohlgriff

Hachoir

single blade, one piece, 1.2 mm thick 18/0 stainless steel, satin polished finish



Art-Nr. Part No.	Länge Length cm	Klingenbreite Blade Width cm	Höhe gesamt Overall Height cm
742/250	25	4,5	16



Wiegemesser

einschneidig, aus X65CrMoV15-Stahl, seidenmatt poliert, mit Griffen aus schwarzem Polyethylen, schwere Qualität

Hachoir

single blade, molybdenum vanadium stainless steel, satin polished, with black polyethylene handles, heavy gauge



Art-Nr. Part No.	Länge Length cm	Klingenbreite Blade Width cm	Höhe gesamt Overall Height cm
740/175	17,5	3,7	12



Doppel-Wiegemesser

zweischneidig, aus Edelstahl 18/0, mit Griffen aus Polyethylen

Hachoir

double blade, 18/0 stainless steel, with black polyethylene handles



Art-Nr. Part No.	Länge Length cm	Klingenbreite Blade Width cm	Höhe gesamt Overall Height cm
744/220	22	5	16



Doppel-Wiegemesser

zweischneidig, geschärfter Edelstahl 18/0, mit schwarzen Griffen aus Polypropylen, Solinger Spitzenqualität

Hachoir

double blade, stainless steel, with black polypropylene handles, made in Solingen, Germany



Art-Nr. Part No.	Länge Length cm	Klingenbreite Blade Width cm	Höhe gesamt Overall Height cm
741/200	20	4,5	15,5



Doppel-Wiegemesser

zweischneidig, aus Messerstahl, seidenmatt poliert, mit lackierten Holzgriffen

Hachoir

double blade, stainless steel, satin polished finish, with lacquered wooden handles



Messerzubehör

Verlängern Sie die Lebensdauer und Effektivität Ihrer Messer. Schärfen Sie Klingen, bewahren Sie Ihre Messer sicher auf und schneiden auf schonenden Schneidbrettern.

Knife Accessoires

Extend the life and effectiveness of your knives. Sharpen blades, store your knives safely and use a choice of cutting boards.

Wetzstahl, rund

aus Chrom-Vanadium, hart verchromt, schwarzer ABS-Griff mit Fingerschutz und Ring, schwere Profiqualität

Round Steel

chrome vanadium steel, black ABS handle with finger guard and ring, professional quality



Art-Nr. Part No.	Klingenlänge Blade cm	Klingenlänge Blade Zoll	Länge gesamt Total Length cm	Ø dia. mm
3340/250	25	10"	40	12
3340/300	30	12"	45	12

Wetzstahl, rund

aus Chrom-Vanadium, hart verchromt, schwarzer ABS-Griff mit Aufhängeloch, schwere Profiqualität

Round Steel

chrome vanadium steel, black ABS handle with hanging hole, professional quality



Art-Nr. Part No.	Klingenlänge Blade cm	Klingenlänge Blade Zoll	Länge gesamt Total Length cm	Ø dia. mm
3341/200	20	8"	32	10

Wetzstahl, oval

aus Chrom-Vanadium, ovaler Querschnitt 20 x 10 mm, hart verchromt, schwarzer ABS-Griff mit Fingerschutz und Ring, schwere Qualität

Oval Steel

chrome vanadium steel, oval shape 20 x 10 mm, black ABS handle with finger guard and ring, professional quality



Art-Nr. Part No.	Klingenlänge Blade cm	Klingenlänge Blade Zoll	Länge gesamt Total Length cm	Ø dia. mm
3342/300	30	12"	45	20 x 10

Wetzstahl, rund

aus Chrom-Vanadium, Stahldurchmesser 10 mm, hart verchromt, Polypropylen-Griff mit Fingerschutz und Ring schwere Profiqualität

Round Steel

Chrome Vanadium steel, diameter 10 mm, black polypropylene handle with finger guard and ring, professional quality



Art-Nr. Part No.	Klingenlänge Blade cm	Klingenlänge Blade Zoll	Länge gesamt Total Length cm
3346/230	23	9"	36

Art-Nr. Part No.	Länge Length cm	Breite Width cm	Höhe Height cm
3347/180	18	6	1,4



Abziehstein

aus Aluminiumoxid, 1000er Körnung für feinen Klingenschliff, Bankstein auf verrutschhinderndem Sockel aus thermoplastischem Kunststoff

Whetstone

aluminium oxide (Corundum), 1000 grit, on non-slip TPE base, for honing knife blades



Art-Nr. Part No.	Länge Length cm	Breite Width cm
3345/003	19,5	5

Nicht für gewellte Klingen oder Scheren geeignet.
Do not use for serrated blades or scissors.



Schärfer für Messerklingen

mit zwei Schärfeilen für Grob- und Feinschliff an glatten Klingen, Vor- und Rückwärtsbewegung möglich, Griff aus Edelstahl und ABS, auf rutschfester Unterlage aus thermoplastischem Kunststoff, Gerät kann gut auf dem Tisch mit einer Hand gehalten werden

Knife Sharpener

with two slots coarse for sharpening and fine honing, bi-directional movement, stainless steel and ABS handle, TPE non-slip base, can be comfortably held steady on a work surface with one hand



Art-Nr. Part No.	Länge Length cm	Ø Rädchen Ø Wheel cm
979/190	19	2,5



Messerschärfer

Serie POLARIS, mit Griff aus Edelstahl 18/10, sechs gehärtete Schleifrädchen aus hochglänzendem Edelstahl 18/0, mit Loch - daher auch zum Festschrauben auf Arbeitsplatten geeignet

Knife Sharpener

with hanging loop, 18/10 stainless steel handle, 18/0 stainless steel wheels, with screw hole for table-top mounting



Art-Nr. Part No.	Länge Length cm	Breite Width cm	Höhe Height cm
---------------------	-----------------------	-----------------------	----------------------

PRODUKTION
EINGESTELLT
PRODUCTION
DISCONTINUED



Messerblock

aus Edelstahl draht, mit herausnehmbaren Platten aus Polyethylen, dadurch gut zu Reinigen, schwere Qualität

Knife Block

stainless steel wire, with removable polyethylene inserts, easy to clean, heavy gauge



Art-Nr. Part No.	Länge Length cm	Breite Width cm	Höhe Height cm
3660/009	19	10	21



Messerblock

aus klar lackiertem Buchenholz, massiv ohne Hohlraum, rutschfest durch Gummifüßchen, mit Einstecköffnungen für einen Wetzstahl und mehrere Messer bis 26 cm Klingenlänge sowie eine Schere, hochwertige Verarbeitung

Knife Block

lacquered massive beechwood, suitable for 1 round steel and 7 knives, non-slip feet, very high quality



Messerkorb

aus Edelstahl draht 18/10, zum sicheren Transport, Aufbewahren und Spülen von vier Kochmessern bis 27 cm Klingenslänge, zwei Wetzstählen und einem Stechschutzhandschuh, mit Klingenschutz, schwere Qualität

Knife Basket

18/10 stainless steel wire, for safe transport, storage and dishwashing of four max. 27 cm (10.5") cooks knives, two round steels and one chain mail glove, with blade protectors, heavy gauge



Art-Nr. Part No.	Länge Length cm	Breite Width cm	Höhe Height cm
3662/001	18	12	49

Messerrolltasche (ohne Messer)

aus schwarzem Kunstleder, auf Gewebebasis mit rotem Rand und zwei Druckknöpfen, für Messer bis max. 40 cm Länge, zum Selbstbestücken

Knife Wallet (empty)

black imitation leather, covered material with red trim and 2 studs, holds knives up to max. 40 cm



Art-Nr. Part No.	Länge Length cm	Breite Width cm
für 6 Teile: / for 6 parts:		
3661/006	43 cm	42 cm
für 9 Teile: / for 9 parts:		
3661/009	50 cm	47 cm

Lieferung ohne Messer.
Supplied empty.

Magnet-Messerhalter

aus weißem ABS-Kunststoff, mit zwei Magnetschienen, zur Wandmontage

Magnetic Knife Rack

white ABS plastic, with two magnetic bands, for wall mounting



Art-Nr. Part No.	Länge Length cm	Breite Width cm
7988/038	38 cm	5 cm
7988/050	51 cm	5 cm

Magnet-Messerhalter

aus massivem schwarzem ABS-Kunststoff, 2,3 cm stark, mit zwei Magnetschienen, zur Wandmontage

Magnetic Knife Rack

black ABS plastic, with two powerful magnetic bands, for wall mounting



Art-Nr. Part No.	Länge Length cm	Breite Width cm
7987/033	33 cm	4 cm
7987/045	47 cm	4 cm
7987/060	62 cm	4 cm

Magnet-Messerhalter

aus massivem schwarzem PVC-Spezialkunststoff, 2 cm stark, mit zwei Magnetschienen, zur Wandmontage, verdeckte Verschraubung, extra hochwertige Ausführung

Magnetic Knife Rack

solid black PVC special plastic, 2 cm thickness, with two very powerful magnetic bands, for wall mounting, very high quality



Art-Nr. Part No.	Länge Length cm	Breite Width cm
7981/035	35 cm	4,5 cm
7981/050	50 cm	4,5 cm

Art-Nr. Part No.	Länge Length cm	Breite Width cm	Dicke Thickness cm
1510/250	25	15	1
1512/300	30	20	1



Schneidbrett, klein

mit Griffloch, ohne Füßchen, aus weißem niederdichten Polyethylen, lebensmittelgeeignet, hitzebeständig bis +90°C, messerschonend, hygienisch, spülmaschinengeeignet, mittelschwere Qualität

Small Cutting Board

without feet but with cut out handle, white low density polyethylene, food safe, hygienic, heat resistant up to +90°C, dishwasher proof, medium duty



Art-Nr. Part No.	GN	Länge Length cm	Breite Width cm	Dicke Thickness cm
1520/325	1/2	32,5	26,5	2
1514/350		35	25	2
1520/532	1/1	53	32,5	2
1517/440		44	29	2
1522/600		60	40	2



Schneidbrett

mit Füßchen, aus weißem niederdichten Polyethylen, lebensmittelgeeignet, hitzebeständig bis +90°C, messerschonend, hygienisch, spülmaschinengeeignet, schwere Qualität

Cutting Board

with feet, white low density polyethylene, food safe, hygienic, heat resistant up to +90°C, dishwasher proof, heavy duty



1510/901 Ersatzfüßchen / Spare foot

Art-Nr. Part No.	Länge Length cm	Breite Width cm	Dicke Thickness cm
1523/602	60	40	2

1510/901 Ersatzfüßchen / Spare foot



Schneidbrett mit Safrille

aus weißem niederdichten Polyethylen, lebensmittelgeeignet, spülmaschinengeeignet, hitzebeständig bis +90°C, messerschonend, hygienisch, mit umlaufender Safrille und sechs rutschfesten Standfüßchen, schwere Qualität

Cutting Board

white low density polyethylene, food safe, heat resistant up to +90°C, dishwasher proof, with rim and 6 non slip feet, heavy gauge



Art-Nr. Part No.	GN	Länge Length cm	Breite Width cm	Dicke Thickness cm
1520/533	1/1	53	32,5	3
1520/603		60	40	3
1520/604		60	40	4
1520/750		75	40	4

1510/901 Ersatzfüßchen / Spare foot



Schneidbrett, schwer

mit Füßchen, aus weißem niederdichtem Polyethylen, aus Platten zugeschnitten, daher hochverdichtet, lebensmittelgeeignet, hitzebeständig bis +90°C, messerschonend, hygienisch, spülmaschinengeeignet, schwere Qualität

Heavy Duty Cutting Board

with feet, white low density polyethylene, cut from bars, therefore highly compressed, food safe, hygienic, heat resistant up to +90°C, dishwasher proof, heavy duty



Schneidbrett HACCP

aus farbigem hochdichten Polyethylen, lebensmittelgeeignet, spülmaschinene geeignet, hitzebeständig bis +90°C, messerschonend, hygienisch, schwere Qualität

Colour Coded Cutting Board

durable high density polyethylene, hygienic, dishwasher safe, heat resistant up to +90°C, shrink wrapped, injection moulded, heavy gauge



Art-Nr. Part No.	Länge Length cm	Breite Width cm	Dicke Thickness cm	
ohne Füßchen / without feet				
1524/350	34,5	24,5	1	weiß/white
1524/352	34,5	24,5	1	gelb/yellow
1524/353	34,5	24,5	1	blau/blue
1524/354	34,5	24,5	1	braun/brown
1524/356	34,5	24,5	1	grün/green
1524/359	34,5	24,5	1	rot/red

mit Füßchen / with feet				
1524/450	45	30	1,2	weiß/white
1524/452	45	30	1,2	gelb/yellow
1524/453	45	30	1,2	blau/blue
1524/454	45	30	1,2	braun/brown
1524/456	45	30	1,2	grün/green
1524/458	45	30	1,2	violett/purple
1524/459	45	30	1,2	rot/red

mit Füßchen; GN-Größe 1/1 / with feet; 1/1 GN size				
1524/530	53	32,5	2,5	weiß/white
1524/532	53	32,5	2,5	gelb/yellow
1524/533	53	32,5	2,5	blau/blue
1524/534	53	32,5	2,5	braun/brown
1524/536	53	32,5	2,5	grün/green
1524/539	53	32,5	2,5	rot/red

ohne Füßchen / without feet				
1524/610	61	46	2,5	weiß/white
1524/612	61	46	2,5	gelb/yellow
1524/613	61	46	2,5	blau/blue
1524/614	61	46	2,5	braun/brown
1524/616	61	46	2,5	grün/green
1524/619	61	46	2,5	rot/red

Ersatzfüßchen erhältlich.
Spare feet available.

Schneidunterlage / -matte HACCP

aus flexiblem Polyethylen, mit Loch zum Aufhängen, lebensmittelgeeignet, spülmaschinene geeignet, hochwertige Qualität

Colour Coded Cutting Mats

flexible polyethylene, with hole for hanging, food and dishwasher safe, high quality



Art-Nr. Part No.	Länge Length cm	Breite Width cm	Stärke Thickness	Farbe Colour
Im Set mit vier Matten sortiert in HACCP Farben: rot (Fleisch), gelb (Geflügel), blau (Fisch) und grün (Gemüse) / Packed in set of 4 mats in HACCP colours: red (raw meat), yellow (cooked meat), blue (raw fish) and green (salad and fruit):				
1506/004	37	29	2 mm	
Weitere Farben, einzeln verpackt: / Other colours, singly packed:				
1506/370	37	29	2 mm	weiß/white
1506/378	37	29	2 mm	violett/purple

GN 1/1 Schneidbrett

aus hochdichtem Polyethylen, grob schwarz-weiß marmoriert, lebensmittelgeeignet, spülmaschinene geeignet, mit Füßchen, schwere Qualität

GN 1/1 Cutting Board

high density polyethylene, black and white marbled, food and dishwasher safe, with feet, heavy duty



Art-Nr. Part No.	Länge Length cm	Breite Width cm	Dicke Thickness cm	GN
1515/530	53	32,5	2,5	1/1

Ersatzfüßchen erhältlich
Spare feet available

Schneidbrett, Antirutsch-

aus schwarzem Polypropylen, mit rutschfestem grünen Rand aus thermoplastischen Elastomere, lebensmittelgeeignet, spülmaschinene geeignet, speziell geeignet für Bars

Non Slip Cutting Board

black polypropylene, with non-slip TPE green edge, food and dishwasher safe, especially suitable for bars



Art-Nr. Part No.	Länge Length cm	Breite Width cm	Dicke Thickness cm
1590/265	26,5	18,5	1

Art-Nr. Part No.	Länge Length cm	Breite Width cm	Höhe Height cm	Stärke Thickness cm
1504/300	30	20	1	0,5
1504/400	40	30	1	0,5



Glas-Schneidbrett

aus gehärtetem schlagfestem Industrieglas mit geriffelter Oberfläche, rutschfeste Füßchen, spülmaschinenfest, sehr hygienisch, geruchsneutral, kein Verfärben der Oberfläche, unempfindlich gegen Hitze- und Kälteschock, nahezu unzerbrechlich

Glass Cutting Board

very robust industrial glass, ribbed surface, non slip feet, dishwasher proof, very hygienic, odour and temperature resistant, virtually unbreakable



Art-Nr. Part No.	Breite Width cm	Tiefe Depth cm	Höhe Height cm
---------------------	-----------------------	----------------------	----------------------

Für Bretter bis 25 mm Stärke / For boards up to 25 mm thick:

1505/300	27	32	28
----------	----	----	----

Für Bretter bis 50 mm Stärke: / For boards up to 50 mm thick:

1505/550	43	32	28
----------	----	----	----

Ersatzfüßchen erhältlich

Spare feet available



Schneidbretthalter

aus Edelstahl, elektropoliert Draht (6 mm), mit Gummifüßchen, für sechs Schneidbretter mit Mindestlänge 30 cm, schwere Qualität

Cutting Board Rack

stainless steel, electro-polished 6 mm wire, for 6 boards (each minimum 30 cm long), heavy gauge



Art-Nr. Part No.	Breite Width cm	Tiefe Depth cm	Höhe Height cm
1507/007	29	28	55

Lieferung mit Schrauben und Dübeln.

Supplied with wall fixings.

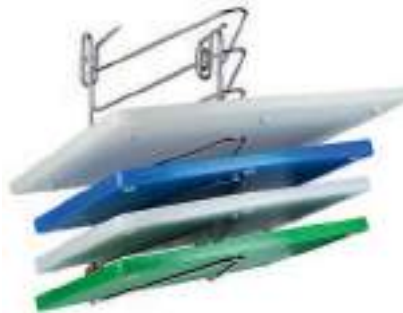

Wand-Schneidbretthalter

aus Edelstahl, elektropoliert Draht (8 und 6 mm), für sieben Schneidbretter mit mindestens 30 cm Breite oder Deckel über 28 cm Durchmesser, für Teile bis zu 55 mm Dicke, sehr stabile Ausführung

Cutting Board Wall Rack

stainless steel, electro-polished 8 and 6 mm wire, for 7 boards (minimum 30 cm long, maximum 55 mm thick), also suitable for 28 cm diameter minimum lids, heavy gauge



Art-Nr. Part No.	Länge Length	Breite Width
1508/200	20 cm	7 cm

1508/999 zwei Ersatzklingen / two spare blades



Schneidbretthobel

aus glasfaserverstärktem Polyamid, Griff aus Melamin, ausschließlich für Schneidbretter aus Polyethylen, Nutzbreite 6,5 cm, mit auswechselbarer Klinge aus gehärtetem Edelstahl

Board Scraper

made of reinforced grey polyamide, melamine handle, for polyethylene boards only, with 6.5 cm steel blade, used to plane cutting boards to ensure they are kept smooth and cut free eliminating food traps



Art-Nr. Part No.	Länge Length	Klingenbreite Blade Width
1509/330	33 cm	9 cm

1509/999 Ersatzklinge / spare blade



Schneidbretthobel

Rahmen aus 7 mm Edelstahldraht 18/10, Klinge aus geschärftem 3,2 mm Messerstahl, für Holz- und Kunststoffbretter geeignet, schwere Qualität

Board Scraper

18/10 stainless steel, blade 3.2 mm made of tempered steel, suitable for wooden as well as for plastic boards, heavy gauge





Fleischartbeitung

Burger, Patties oder Roulade. Dry aged Steak oder Wiener Schnitzel. Zerlegen und Bearbeiten Sie das Fleisch mit den passenden Werkzeugen bevor es auf den Grill oder in den Ofen kommt.

Meat Preparation

Prepare, cut and cook all of your meats with this range of tools.

Fleischwolf

aus verzinnem Eisenguss, mit Vorsatz für Spritzgebäck, Schraubzwinne zur Tischmontage bis maximal 3,5 cm, 4-flügeliges Messer, Scheibe mit 4,5 mm Lochung, Griff aus lackiertem Holz, zerlegbar, nicht spülmaschineneeignet

Mincer

tin plated cast iron, with biscuit attachment, screw clamp for table mounting up to 3.5 cm, 4 blade knife, mincing plate with 4.5 mm holes, lacquered wood handle, can be taken apart, not dishwasher safe



Art-Nr. Part No.	Höhe Height	Ø dia.	Größe Size
585/005	24,5 cm	5 cm	5
585/945	Ersatz-Lochscheibe 4,5 mm / Spare 4.5 mm hole mincing plate		
585/008	26 cm	6 cm	8
585/928	Ersatzmesser / Spare 4 blade knife		
585/948	Ersatz-Lochscheibe 4,5 mm / Spare 4.5 mm hole mincing plate		

Hackfleischpresse, Edelstahl

aus Edelstahl, elektropliert, mit Pattyauswerfer, spülmaschineneeignet, zur Reinigung zerlegbar, schwere Qualität

Burger Press

cast stainless steel, electro-polished, with ejector, heavy gauge, dismountable for cleaning, dishwasher safe



Art-Nr. Part No.	Ø dia. cm	Höhe innen Inner Height cm	Höhe Height cm	Portionsgröße Portion size
1357/125	12,5	3,5	16	450 g



Art-Nr. Part No.	∅ innen ∅ Inside cm	Höhe innen Inner Height cm	Höhe Height cm	Portionsgröße Portion size
1358/050	5	2,7	10,5	50 g
1358/060	6	2,7	10,5	75 g
1358/085	8,5	2,7	10,5	150 g



Hackfleischpresse, Edelstahl

aus Edelstahl, geschweißt, mit Pattyauswerfer, spülmaschinenfest

Burger Press

stainless steel, welded, with ejector, dishwasher safe



Art-Nr. Part No.	∅ dia. cm	Höhe innen Inner Height cm	Höhe Height cm	Portionsgröße Portion size
1355/100	10	4	16	275 g
1355/125	12,5	4	17	400 g



Hackfleischpresse

aus Aluminiumguss, mit Pattyauswerfer, nicht spülmaschinenfest, schwere Qualität

Burger Press

cast aluminium, with ejector, not dishwasher proof, heavy duty



Art-Nr. Part No.	∅ dia. cm	Höhe gesamt Overall Height cm
Einfache Ausführung / Single version:		
1351/110	11,5	8

Doppelte Ausführung: / Double version:		
1352/280	11,5	9

Lieferung unmontiert
Supplied flat packed



Hamburgerpresse

aus Aluminiumguss, Kunststoffgriff, PTFE antihaft-beschichtet, spülmaschinengeeignet

Burger Press

cast aluminium pusher, plastic handle & base, PTFE non-stick coated, dishwasher proof



Art-Nr. Part No.	∅ dia. cm	Höhe Height cm	Gewicht Weight kg
5782/175	17,5	8	1



Grillpresse

aus Eisenguss, hoch erhitzbar, nicht spülmaschinengeeignet, gerillte Oberfläche brennt das Grillmuster auf Steaks, mit Holzgriff, zum Anpressen von Grillgut, Steaks und Burgern, schwere Qualität

Steak Weight

cast iron, high heat able, not dishwasher safe, with wooden handle, to help cook meat evenly and to create a char grilled effect



Art-Nr. Part No.	∅ innen ∅ Inside cm	Höhe innen Inner Height cm	∅ oben ∅ Top cm
6487/150	15	9	9



Cloche für Burger

aus Edelstahl 18/10, mit großem Griff, verhindert das Austrocknen des Burgers auf dem Grill

Burger Cloche

18/10 stainless steel, with wide handle, prevents the burger from becoming dry



Hackbeil

aus Messerstahl, seidenmatt poliert, mit unlackiertem Griff aus edlem Hartholz, nicht spülmaschineneeignet, schwere Qualität

Cleaver

stainless steel, satin polished finish, with dark wooden handle, not dishwasher safe, heavy gauge



Art-Nr. Part No.	Länge Length cm	Klingenbreite Blade Width cm	Klingenlänge Blade Length cm
745/180	31	9	18
745/200	33	9,5	20

Hackbeil

aus Chrom-Molybdän-Vanadium-Klingenstahl, mit vernietetem Griff aus schwarzem Polypropylen, spülmaschineneeignet, extra schwere Profi-Qualität

Cleaver

Molybdenum Vanadium stainless steel blade, with black riveted polypropylene handle, dishwasher proof, very heavy gauge, professional quality



Art-Nr. Part No.	Länge Length cm	Klingenbreite Blade Width cm	Klingenlänge Blade Length cm
3655/200	33	9	20

Hackbeil

Klinge aus Chrom-Molybdän-Vanadium (x50CrMoV15), Griff aus schwarzem Polypropylen, spülmaschineneeignet

Cleaver

chrome-molybdenum-vanadium (x50CrMoV15) blade, polypropylene plastic handle, dishwasher safe



Art-Nr. Part No.	Länge Length cm	Klingenbreite Blade Width cm	Klingenlänge Blade Length cm
6041/160	30	10	16

Knochen-/Fleischersäge

aus Edelstahl, hochglänzend, mit schwarzem ABS-Griff, schwere Qualität

Butchers Saw

stainless steel, mirror polished finish, with black ABS handle, heavy gauge



Art-Nr. Part No.	Länge Length cm	Klingenbreite Blade Width cm	Klingenlänge Blade Length cm
2144/450	62	2	45
2144/901	Ersatzsägeblatt hierzu / Spare blade		

Fleischhaken

aus Edelstahl 18/0, mit je einem stumpfen und spitzen Ende, schwere Qualität

Meat Hook

18/0 stainless steel, with one blunt and one pointed end, heavy gauge



Art-Nr. Part No.	Länge Length cm	Stärke Thickness mm	Ø Rohr Ø Tube cm
485/080	8,5 cm	4 mm	2,8
485/100	10 cm	4 mm	2,8
485/120	12 cm	5 mm	3,5
485/140	14 cm	6 mm	3,8
485/160	16 cm	6 mm	4,2
485/180	18 cm	6 mm	4,2
485/200	20 cm	9 mm	4,8
485/250	25 cm	10 mm	5,8

Preis je Stück. Empfohlene Verpackungseinheit 10 Stück.
Priced each. Recommended packing unit 10 pcs.

Hackblöcke

Chopping Blocks



Art-Nr. Part No.	Länge Length cm	Breite Width cm	Höhe Height cm
1503/530	53	32,5	6

Passend darauf Rolltop-Haube GN 1/1 für Buffet: / Matches a GN 1/1 lid:

645/530	54	33,5	19
---------	----	------	----

Ersatzfüßchen erhältlich.
Spare feet available.



Holzschneidblock GN 1/1

aus 5 cm starkem Buchen-Stirnholz, besonders robust, lebensmittelecht geölt, mit Safrinne und Griffmulden, auf vier Gummifüßen, nicht spülmaschinengeeignet, extra schwere Qualität, zum Zerlegen und Tranchieren von Fleisch oder Geflügel oder als Buffet-Platte verwendbar

GN 1/1 Cutting Board

5 cm thick beech wood, particularly durable, food friendly oiled, 4 rubber feet, not dishwasher safe, extra heavy gauge, for cutting and carving meat or poultry or as a buffet plate



Art-Nr. Part No.	Länge Length cm	Breite Width cm	Höhe Height cm
3643/303	30	30	65
3643/404	40	40	60
3643/504	50	40	60
3643/505*	50	50	60

Edelstahlfuß für Holzhackblöcke: / Stainless steel stand:

3643/303	30	30	65
3643/404	40	40	60
3643/504	50	40	60
3643/505*	50	50	60

Hackblock aus Weißbuche: / Beech wood chopping block:

3644/303	30	30	20
3644/404*	40	40	25
3644/504*	50	40	25
3644/505*	50	50	30

*Versand dieser Größen nur per Spedition möglich.

*For these sizes pallet delivery only.

Untergestell und Block ergeben eine Arbeitshöhe von etwa 85 cm.
The height of stand and block together is about 85 cm.



Hackblock aus Holz

aus Weißbuche, verleimt und verzahnt, ohne Spannreifen. Separat bestellen: stabiles Untergestell aus 40 mm Vierkantstahlrohr aus Edelstahl 18/10, matt gebürstet, mit höhenverstellbaren Füßen aus Kunststoff

Chopping Block

beech wood, Please order separately: 18/10 stainless steel square 40 mm tubular stand with adjustable feet



Art-Nr. Part No.	Länge Length cm	Breite Width cm	Höhe Height cm
3642/404	40	40	8
3642/504*	50	40	8
3642/505*	50	50	8

Edelstahlfuß für PE-Hackblöcke: / Stainless steel stand:

3642/404	40	40	8
3642/504*	50	40	8
3642/505*	50	50	8

Hackblock aus HD-Polyethylen: / Polyethylene Chopping Block:

3645/404	40	40	8
3645/504	50	40	8
3645/505	50	50	8

*Versand dieser Größen nur per Spedition möglich.

*For this sizes pallet delivery only.

Untergestell und Block ergeben eine Arbeitshöhe von etwa 85 cm.
The height of stand and block together is about 85 cm.



Hackblock aus Polyethylen

aus weißem HD-Polyethylen 500. Separat bestellen: stabiles Untergestell aus 40 mm Vierkantstahlrohr aus Edelstahl 18/10, matt gebürstet, mit höhenverstellbaren Füßen aus grauem Kunststoff

Chopping Block

polyethylene Please order separately: 18/10 stainless steel square 40 mm tubular stand with adjustable feet



Art-Nr. Part No.	Länge Length cm	Breite Width cm	Borstenlänge Bristle Length cm
5872/190	19	7,5	4



Hackblockbürste

mit flachen gehärteten Stahldrahtborsten, nicht rostfrei, Halteschleife und Griffplatte aus Polypropylen

Chopping Block Brush

with steel wire bristles, polypropylene handle



Kotelettklopper

aus massivem Edelstahl 18/0, hochglänzend,
mit vernietetem POM-Griff, gekröpft, schwere Profi-Qualität

Meat Tenderiser

18/0 stainless steel, mirror polished finish, cranked,
with riveted POM handle, very heavy gauge,
professional quality



Art-Nr. Part No.	Fläche Size cm	Länge gesamt Total Length cm	Gewicht Weight kg
3656/110	13 x 8,5	31	1

Kotelettklopper

aus massivem Edelstahl 18/0, hochglänzend

Meat Tenderiser

solid stainless steel, mirror polished finish



Art-Nr. Part No.	Fläche Size cm	Länge gesamt Total Length cm	Gewicht Weight kg
2131/100	13 x 11,5	28	1

Fleischklopper

aus massivem Zinkguss, verchromt, glanzgebürstet,
mit Aufhängeöse, nicht spülmaschinengeeignet

Meat Tenderiser

chrome plated zinc alloy, brushed finish with hanging
loop, heavy gauge, not dishwasher safe



Art-Nr. Part No.	Stiellänge Handle Length cm	Ø dia. cm	Gewicht Weight kg
1075/075	29,5	9,5	0,75

Mit geriffelter Klopffläche: / with ridged surface:

1075/095	29,5	9,5	0,75
----------	------	-----	------

Mit glatter Klopffläche: / with plain surface:

Fleischklopper

aus massivem Edelstahl 18/0, hochglänzend poliert,
mit glatter Klopffläche, spülmaschinengeeignet

Meat Tenderiser

18/0 stainless steel, mirror polished finish, heavy gauge,
dishwasher safe



Art-Nr. Part No.	Höhe Height cm	Ø dia. cm	Gewicht Weight kg
1616/100	11	8,5	1
1616/150	12	10	1,5
1616/200	14	11	2

Fleischhammer

aus Aluminium, hochglanzpoliert, mit einer glatten und
einer geriffelten Klopffläche 7 x 7 cm,
nicht spülmaschinengeeignet

Meat Tenderiser

aluminium, mirror polished finish, with plain and ridged
surfaces 7 x 7 cm, not dishwasher proof



Art-Nr. Part No.	Länge Length cm	Gewicht Weight kg
1092/255	25,5 cm	0,4 kg

Fleischhammer

3 Klopfflächen je 60 x 50 mm aus robustem Aluminium-
guss, davon eine glatt, handlicher ABS-Griff,
nicht spülmaschinengeeignet

Meat Tenderiser

3 different surfaces each 60 x 50 mm, one of them flat,
made of cast aluminium, ergonomic ABS handle,
not dishwasher safe



Art-Nr. Part No.	Länge Length cm	Gewicht Weight kg
1093/100	27 cm	1 kg



Art-Nr. Part No.	Länge gesamt Total Length	Ø Draht Ø Wire
855/100	10 cm	3,2 mm
855/200	20 cm	3,2 mm
855/250	25 cm	3,2 mm
855/300	30 cm	3,2 mm
855/350	35 cm	3,2 mm

Verpackung/Preis à 12 Stück.
Priced & packed in dozens.



Fleischspieße, rund

bzw. Rouladennadeln, runder Querschnitt, aus Edelstahl, hochglänzend

Skewers

stainless steel, mirror polished, round



Art-Nr. Part No.	Länge gesamt Total Length
55/200	20 cm
55/250	24,5 cm
55/300	29 cm

Verpackung/Preis à 12 Stück.
Priced & packed in dozens.



Fleischspieße, kantig

aus Edelstahl 18/0, matt poliert, kantiger Querschnitt

Skewers

18/0 stainless steel, matt polished finish, angular



Art-Nr. Part No.	Höhe Height	Ø Boden Ø Base	passend zu Matches
Hängegestelle ohne Spieße: / Skewer Racks without skewers:			
3328/001	46	22	
3328/045	51	22	
Spieße bitte separat bestellen: / Please order skewers separately:			
3329/400	40		3328/001
3329/450	45		3328/045

Porzellanteller nicht im Lieferumfang enthalten.
Porcelain plate is not included.



Fleischspieß-Aufhänger

Drahtgestell aus 8 mm Edelstahl, zum Servieren oder Bereithalten von Fleischspießen bis 40/45 cm Länge, schwere Qualität

Espetada/Kebab Skewer Rack

stainless steel 8 mm wire, for skewers up to 40/45 cm length, heavy gauge



Art-Nr. Part No.	Länge gesamt Total Length	Klingenlänge Blade Length
1155/270	27 cm	21,5

Verpackung/Preis à 3 Stück.
Priced & packed in 3's.



Fleischspieße

aus gehärtetem Edelstahl 18/0, matt poliert, Materialstärke: 5x2 mm, mit kantigem Querschnitt

Skewers

18/0 hardened stainless steel, matt polished finish, angular, material thickness: 5x2 mm



Bratenspieß

aus Edelstahl 18/0, mit Schwertgriff aus Messing

Skewer

stainless steel, with brass handle



Art-Nr. Part No.	Länge gesamt Total Length cm	Klingenlänge Blade Length cm
1165/350	35	22
1165/450	45	32
1165/650	65	52

Fleischspieß

aus Edelstahl, mit Motivgriff aus massivem Messing

Skewer

stainless steel, with brass handle

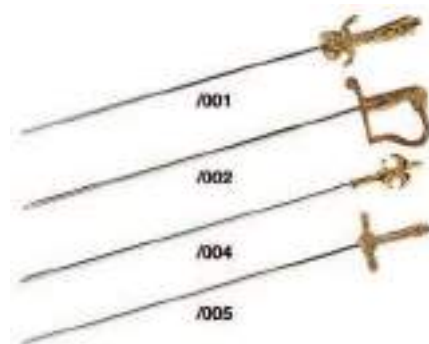

Art-Nr. Part No.	Länge gesamt Total Length cm	Klingenlänge Blade Length cm
Säbel: / Sabre:		
1166/001	29,5 cm	24,5
Degen: / Rapier:		
1166/002	29,5 cm	24,5
Französische Lilie: / Fleur-de-Lis:		
1166/004	30,5 cm	25
Schwert: / Sword:		
1166/005	29,5 cm	24,5

Grillspieße

aus Edelstahl 18/10, seidenmatt gebürstet, mit Aufhängeöse und beweglicher Abstreifhilfe, die gedrehte Spitze verhindert Abgleiten des Grillguts und des Abstreifers

Barbecue Skewers

18/10 stainless steel, satin polished finish



Art-Nr. Part No.	Länge gesamt Total Length cm	Klingenlänge Blade cm
455/450	45	32
Preis und Verpackung à 4 Stück Priced & packed in 4's		

Falafel-Portionierer

zum Formen orientalischer Falafel, Edelstahl 18/10, mit Auswerfer

Falafel Portionier

18/10 stainless steel, with ejector



Art-Nr. Part No.	Portionsgröße Portion size	Ø innen Ø Inside cm	Länge Length cm
246/045	1/45 l = 0,022 l	5	15
246/070	1/70 l = 0,014 l	4	15



Art-Nr. Part No.	Breite Width cm	∅ min. cm	∅ max. cm
112/006	0,7	4,3	5

Preis und Verpackung à 6 Stück.
Priced/packed in 6's.



Rouladenringe

aus Edelstahl 18/0

Roulade Rings

18/0 stainless steel



Art-Nr. Part No.	Länge Length cm	Höhe Height cm
153/050	5,5 cm	5 cm

Preis und Verpackung à 4 Stück
Priced/packed in 4's.



Rouladenklammern

aus Edelstahl 18/10

Rolled meat holders

18/10 stainless steel



Art-Nr. Part No.	Länge Length cm	∅ dia. cm	0,05 l
149/320	32	2,3	



Bratensauptspritze

aus Edelstahl 18/10, seidenmatt gebürstet,
Spitze abschraubbar, Lieferung mit Spülbürste

Baster

18/10 stainless steel, matt polished finish,
nozzle screws on, with cleaning brush



Art-Nr. Part No.	Länge Length cm	∅ Draht ∅ Wire mm
150/200	19,5 cm	5,4 mm



Spicknadel

aus Edelstahl 18/0, hochglänzend, mit gezahntem
Endstück zur rutschfesten Sicherung des Speckstreifens

Larding Needle

18/0 stainless steel, mirror polished finish



Art-Nr. Part No.	Länge Length cm	∅ Draht ∅ Wire mm
151/180	18 cm	3 mm
151/200	20 cm	3 mm



Dressiernadel, gebogen

aus Edelstahl 18/10, matt poliert, zum Zunähen des
gefüllten Bratens

Trussing Needle

18/10 stainless steel, matt polished finish



Art-Nr. Part No.	Länge Length cm	∅ Draht ∅ Wire mm
1159/180	18	3
1159/200	20	3



Dressiernadel, gerade

aus Edelstahl 18/10

Trussing Needle

straight, 18/10 stainless steel



Bratenschnur

aus weißem Polyester

String

white polyester



Art-Nr.	Länge
Part No.	Length
3881/150	150 m

Auch als Nachfüllung in Spenderdose 3882/150 geeignet
Can be used as a refill for 3882/150.

Bratenschnur

aus weißem Polyester, in wiederverwendbarer Spenderdose

String

white polyester, in reusable dispenser



Art-Nr.	Länge
Part No.	Length
3882/150	150 m

Grill- und Bratenschnur

naturfarbene hitzebeständige Schnur aus Naturfasern

String

natural material, heat resistant



Art-Nr.	Länge	Gewicht
Part No.	Length	Weight
feste dünne Schnur für Spargel, Lachs, Schinken ohne Spenderbox: / tight thin string for asparagus, salmon, ham:		
3880/160	150 m	100 g

Im wiederverwendbarem klaren Kunststoffspender, dickere weiche Schnur insbesondere für Braten: / In reusable clear plastic dispenser, thicker softer string for meat:

3880/150	150 m	105 g
----------	-------	-------

Rollbratenfaden

aus rot-weißem Polyester, in wiederverwendbarer Spenderdose

String

red and white striped polyester, in reusable dispenser



Art-Nr.	Länge
Part No.	Length
3884/153	150 m

Ersatzrolle ohne Dose: / Refill string without dispenser:

3886/100	100 m
----------	-------

Wurstgarn

aus Naturfasern, lebensmittelecht, zum Bündeln, Dressieren und Abbinden von Speisen

Butchers String

natural, food safe



Art-Nr.	Länge	Gewicht
Part No.	Length	Weight

naturfarben: / natural:

3883/100	100 m	85 g
3883/200	200 m	170 g

rot-weiß gefärbt: / red + white striped:

3883/232	200 m	200 g
----------	-------	-------

Maiskolbengabeln

aus Edelstahl 18/0, mit großen gelben Kunststoffgriffen

Corn-on-the-cob Forks

18/0 stainless steel, with large yellow plastic handles



Art-Nr.	Zinkenlänge	Stiellänge
Part No.	Prongs Length	Handle Length
4698/008	3 cm	6 cm

Preis und Verpackung à 8 Stück.
Priced/packed in 8's.



Art-Nr.	Länge
Part No.	Length
5660/420	42 cm



Grillzange

aus 1,5 mm starkem Edelstahl 18/10, hochglänzend, mit seidenmattem ovalen Rohrgriff, gezahnte Greifer, hochwertige Qualität

Barbecue Tongs

1.5 mm thick 18/10 stainless steel, mirror polished, with satin polished oval handles, serrated blades, heavy gauge



Art-Nr.	Spatelmaß	Länge gesamt
Part No.	Blade	Total Length
	cm	
5661/450	11 x 9	45 cm



Grillwender

aus 1,5 mm starkem Edelstahl 18/10, hochglänzend, mit seidenmattem ovalen Rohrgriff, geschlitzte Fläche beidseitig gezahnt und vorne verjüngt, hochwertige Qualität

Barbecue slice

1.5 mm thick 18/10 stainless steel, mirror polished, with satin polished oval handle, serrated, slotted blade, heavy gauge



Art-Nr.	Zinkenlänge	Länge gesamt
Part No.	Prongs Length	Total Length
	cm	
5662/440	9 cm	44 cm



Grillgabel

aus 1,5 mm starkem Edelstahl 18/10, hochglänzend, mit seidenmattem ovalen Rohrgriff, hochwertige Qualität

Barbecue Fork

1.5 mm thick 18/10 stainless steel, mirror polished, with satin polished oval handle, heavy gauge



Art-Nr.	Länge
Part No.	Length
5669/004	42 cm - 45 cm



Grill-Set, 4-teilig

aus 1,5 mm starkem Edelstahl 18/10, hochglänzend, mit seidenmattem ovalen Griff, hochwertige Qualität

Barbecue Utensils Set

1.5 mm thick 18/10 stainless steel, mirror polished, with satin polished oval handles, heavy gauge



Geflügelschere

aus Edelstahl 18/0, gebogene Form, mit Innenfeder, besonders hygienisch, leicht zerlegbar, erleichtert die Reinigung

Poultry Shears

curved, 18/0 stainless steel, with internal spring, very hygienic, dismountable for cleaning

18/0
EDELSTAHL
STAINLESS STEEL



Art-Nr. Part No.	Länge Length	Klingenlänge Blade Length
14/240	24 cm	10,5 cm

Geflügelschere

aus geschmiedetem Edelstahl 18/0, schwarze POM-Griffschalen mit Edelstahlnieten, mit Innenfeder, leicht zerlegbar, erleichtert die Reinigung

Poultry Shears

18/0 forged stainless steel, black POM handles with stainless steel rivets and internal spring, dismountable for cleaning

18/0
EDELSTAHL
STAINLESS STEEL

GESCHMIEDET
FORGED

POM
POLYPROPYLEN
METHYLEN



Art-Nr. Part No.	Länge Length	Klingenlänge Blade Length
19/250	25 cm	8 cm

Geflügelschere

aus Edelstahl 18/0, mit Pufferfeder, leicht zerlegbar, erleichtert die Reinigung

Poultry Shears

narrow, 18/0 stainless steel, with spring, dismountable for cleaning

18/0
EDELSTAHL
STAINLESS STEEL



Art-Nr. Part No.	Länge Length	Klingenlänge Blade Length

PRODUKTION
INGESTELLT
PRODUCTION
DISCONTINUED

Geflügelschere

gebogene Form, aus Edelstahl 18/0, mit Pufferfeder, leicht zerlegbar, erleichtert die Reinigung

Poultry Shears

curved, 18/0 stainless steel, with spring, dismountable for cleaning

18/0
EDELSTAHL
STAINLESS STEEL



Art-Nr. Part No.	Länge Length	Klingenlänge Blade Length
17/240	25 cm	8 cm

17/901 Ersatzfeder / Spare spring

Art-Nr. Part No.	Länge Length	Klingenlänge Blade Length
54/210	22 cm	10 cm



Küchenschere

aus geschmiedeten Edelstahl 18/0, mit rot beschichtetem Griff, gute Schnitteigenschaft durch gezahnte Gegenschneide, hygienische Reinigung durch leichte Zerlegung der Schere

Kitchen Scissors

18/0 forged stainless steel, with red lacquered handle, with one plain and one serrated blade, hygienic, can be taken apart for cleaning



Art-Nr. Part No.	Länge Length	Klingenlänge Blade Length
156/210	20 cm	9 cm



Küchenschere

aus Messer Stahl mit schwarzem ABS-Griff, mit gezahnter Vorrichtung zum Öffnen von Flaschenverschlüssen und Kronkorken, Schere ist nicht zerlegbar

Kitchen Scissors

stainless steel, with black ABS handles, cannot be taken apart for cleaning



Art-Nr. Part No.	Länge Length	Klingenlänge Blade Length
154/210	21 cm	10 cm



Universalschere

für Rechtshänder, aus Edelstahl 18/0 mit rotem, ergonomisch geformtem ABS-Griff, Schere ist nicht zerlegbar

Kitchen Scissors

18/0 stainless steel, with ergonomically shaped red ABS handles, cannot be taken apart for cleaning



Art-Nr. Part No.	Länge Length	Klingenlänge Blade Length
159/185	18,5 cm	6,5 cm



Fischschere

aus massivem Edelstahl 18/0, seidenmatt poliert, mit einseitig gezahnter Klinge, schwere Qualität, hygienische Reinigung durch leichte Zerlegung der Schere

Fish Scissors

18/0 stainless steel, satin polished finish, professional quality, with one plain and one serrated blade, hygienic, can be taken apart for cleaning



Art-Nr. Part No.	Länge Length	Klingenlänge Blade Length cm
158/160	16 cm	4,5



Traubenschere

aus massivem Edelstahl 18/0, hochglänzend, hochwertige Ausführung, Schere ist nicht zerlegbar

Grape Scissors

heavy 18/0 stainless steel, mirror polished, high quality, cannot be taken apart for cleaning





Chef Tools

Garniert und verziert. Die hochspezialisierten Küchenwerkzeuge der **contacto** 'Chef Tools' sind für alle Schnitzarbeiten an Obst und Gemüse einsatzbereit.

Chefs Garnishing Tools

Garnish and decorate all manner of fruit and vegetables with this highly specialised range of **contacto** Chef's Tools.

Arbeitsteile sind größtenteils aus Edelstahl 18/0 gefertigt. Die Schneidewerkzeuge sind aus extra geschärftem und gehärtetem, rostfreien Klingensteinahl.

Alle Teile sind mit 10 cm langen, ovalen Griffen aus glasfaserverstärktem Polyamid ausgestattet.

The blades are mainly made of extra sharpened and tempered stainless steel. Other tools are mainly 18/0 stainless steel.

Each item has a 10 cm oval handle made of black fibreglass reinforced polyamide.



- professionelles Garnierset
- spülmaschinenfest
- handliche ovale Griffe
- Solinger Spitzenqualität
- professional tools set
- dishwasher safe
- comfortable handles
- Made in Solingen

Dreieck-Garnierschneider

aus extra geschärftem Edelstahl 18/0, zur Herstellung von Radieschen-Kronen, bzw. Verzierung hartschaliger Gemüsearten



Art-Nr. Part No.	Länge Length	Schneidbreite Cutting Width cm
2233/130	13 cm	2

Radish Decorator

extra sharp

Ziseliermesser

aus extra geschärftem Edelstahl 18/0, zum gleichmäßigen Einritzen von Linien, Mustern und Zackenrändern in hartschaliges Obst und Gemüse



Art-Nr. Part No.	Länge Length
2241/140	14 cm

Canele/Decorator

18/0 stainless steel, extra sharp

Fadenschneider

aus extra geschärftem Edelstahl 18/0, zur Herstellung dünner Streifen aus Gemüse oder Zitruschalen



Art-Nr. Part No.	Länge Length
2247/140	14 cm

Zester

18/0 stainless steel, extra sharp

Fruchtdekoriermesser

aus extra geschärftem gehärteten Edelstahl 18/0, zur Herstellung von Obstkörbchen



Art-Nr. Part No.	Klingenlänge Blade	Länge gesamt Total Length
2232/205	10 cm	20,5 cm

Fruit Decorator

'V' cut, blade 18/0 stainless steel, extra sharp

Art-Nr. Part No.	Klingenlänge Blade Length cm	Länge gesamt Total Length cm
2258/180	5	17,5



Julienneschneider
Klinge aus gehärtetem Messerstahl,
zum Hobeln feiner Streifen aus Gemüse

Julienne Slicer
18/0 tempered steel blade

Art-Nr. Part No.	Klingenbreite Blade Width mm	Länge Length cm
2253/170	9 mm	1,7 cm



Gurkenschneider
mit 8 Klingen aus gehärtetem Messerstahl

Cucumber Slicer
with 8 hardened blades

Art-Nr. Part No.	Klingenlänge Blade Length cm	Länge gesamt Total Length cm
2256/220	11,5 cm	21,5 cm



Zucchiniusstecher
aus gehärtetem Edelstahl 18/0

Courgette / Zucchini Cutter
blade 18/0 stainless steel

Art-Nr. Part No.	Klingenlänge Blade cm	Länge gesamt Total Length cm
2239/165	6 cm	16,5 cm



Orangenschäler
aus gezahntem Edelstahl 18/0, mit Ziselierhaken,
zum Schälen von Zitrusfrüchten ohne das Fruchtfleisch
zu verletzen

Orange Canele
18/0 stainless steel

Art-Nr. Part No.	Länge Length cm	Breite Width cm	∅ dia. mm
2236/002	9	6,5	20 / 38



Deko Twister Set
mit zwei Schneideeinsätzen zum Aushöhlen
von Früchten und Gemüse

Deko Twister Set
18/0 stainless steel, two interchangeable cutting inserts
for removing fruits and vegetables

Art-Nr. Part No.	Klingenlänge Blade cm	∅ dia. cm	Länge gesamt Total Length cm
2248/180	7,5	1,6	18
2248/200	10	1,9	20



Apfelentkerner
aus gehärtetem Edelstahl 18/0, mit gezahnter Sägekante
und extra geschärften Rändern zum Entkernen von
Äpfeln, Birnen usw.

Apple Corer
18/0 stainless steel, sharpened and tempered,
serrated end

Art-Nr. Part No.	Länge Length cm	∅ dia. mm
2259/145	14,5 cm	20 mm



Tomatenentstieler
aus extra geschärftem gehärteten Edelstahl 18/0,
zum einfachen Entfernen des Tomatenstiels

Tomato Stalk Remover
sharpened and tempered 18/0 stainless steel

Art-Nr. Part No.	Länge Length cm
2244/250	16,5 cm



Kugelausstecher
aus extra geschärftem gehärteten Edelstahl 18/0,
für 22 und 25 mm-Kugeln aus Melonen, Kartoffeln usw.

Melon Baller
18/0 stainless steel, 22 and 25 mm scoops

Art-Nr. Part No.	Länge Length cm	∅ dia. mm
2249/010	14 cm	10 mm
2249/015	14,5 cm	15 mm
2249/018	14,5 cm	18 mm
2249/022	15 cm	22 mm
2249/025	15,5 cm	25 mm
2249/030	15,5 cm	30 mm



Kugelausstecher
aus extra geschärftem gehärteten Edelstahl 18/0,
für kleine Perlen und große Kugeln aus Obst
und Gemüse

Melon Baller
18/0 stainless steel, sharpened and tempered

Parisiene-Ausstecher

aus gehärtetem Edelstahl 18/0, zur Herstellung von Pommes Parisienne



Art-Nr. Part No.	Löffelmaß Bowl Size	Länge gesamt Total Length
2243/160	3,5 cm x 2 cm	16 cm

Fluted Oval Melon Baller

tempered

Kartoffelformlöffel, oval

aus extra geschärftem gehärteten Edelstahl 18/0



Art-Nr. Part No.	Löffelmaß Bowl Size	Länge gesamt Total Length
2245/150	3 cm x 1,8 cm	15 cm

Oval Melon Baller

sharpened and tempered

Sparschäler

mit zwei starren Klingen aus extra geschärftem gehärteten Edelstahl 18/0; für Links- und Rechtshänder geeignet



Art-Nr. Part No.	Klingenbreite Blade Width	Länge gesamt Total Length
2246/165	3,5 cm	16,5 cm

Potato Peeler

18/0 stainless steel, sharpened and tempered, suitable for right and left handed

Spargelschäler

mit extra geschärfter, gehärteter Klinge aus Edelstahl 18/0, mit verstellbarer Schiene zur Regulierung der Schäldicke, für Rechtshänder



Art-Nr. Part No.	Klingenlänge Blade	Länge gesamt Total Length
2242/210	10,5 cm	21 cm

Asparagus Peeler

18/0 stainless steel, extra sharpened and tempered blade, with adjustable bar

Pendelschäler

die beweglichen extra geschärften Klingen sind aus Edelstahl 18/0; der Halterahmen ist zweifach vernickelt



Art-Nr. Part No.	Länge Length

Swivel Peeler

extra sharpened blades, right/left-handed



PRODUKTION
EINGESTELLT
PRODUCTION
DISCONTINUED

Trüffelhobel

Rahmen aus hochglänzendem Edelstahl 18/10, Klinge aus gehärtetem Messer Stahl, mit verstärkten Fingerschutz aus Polyamid; zum Hobeln von Trüffeln und Knoblauch, Scheibenstärke verstellbar



Art-Nr. Part No.	Klingenlänge Blade cm	Ø dia. cm	Länge gesamt Total Length cm
2235/255	6	8	25,5

Truffle Mandolin

mirror polished finish, extra sharpened blade made of 18/0 tempered steel, adjustable for varying thickness

Butterroller

aus gezahntem Edelstahl 18/0, zur Herstellung von Butterlocken



Art-Nr. Part No.	Länge Length
2238/190	19 cm

Butter Curler

18/0 stainless steel, serrated edge

Buntschneidemesser/ Tomatenmesser

mit extra geschärfter, gehärteter Klinge aus Edelstahl 18/0



Art-Nr. Part No.	Klingenlänge Blade Length cm	Länge gesamt Total Length
2289/185	8,5	18,5 cm

Garnishing / Tomato Knife

hardened 18/0 stainless steel

Art-Nr. Part No.	Länge Length cm	Schneidbreite Cutting Width cm
2234/225	22,5	5



Käsehobel

aus hochglänzendem geschärften Edelstahl 18/0;
zur Herstellung dünner Käsescheiben aus Halbhartkäse
und Käsespänen aus Hartkäse

Cheese Slicer

Art-Nr. Part No.	Klingenbreite Blade Width cm	Länge gesamt Total Length cm
2251/003	9	20



Scheibenschneider-Set

mit drei auswechselbaren Klingen für 1 mm,
2 mm und 3,5 mm Scheiben

Slicer

with exchangeable blades for 1 mm,
2 mm und 3.5 mm slices

Art-Nr. Part No.	Länge Length cm	Fläche Size cm
2227/230	23	8 x 4



Fischentschupper

aus Edelstahl 18/0

Fish Scaler

18/0 stainless steel

Keine Ersatzmesser erhältlich.
No spare parts available.

Art-Nr. Part No.	Klingenbreite Blade Width cm	Länge Length cm

PRODUKTION
EINGESTELLT
PRODUCTION
DISCONTINUED



Ingwer-/Zitronenreibe

aus Edelstahl 18/10, matt gebürstet, Reibkörper aus
glasfaserverstärktem Polyamid, selbstreinigend durch
Kunststoffnoppen

Ginger and Lemon Grater

18/10 stainless steel, matt brushed finish

Art-Nr. Part No.	Spatelmaß Blade cm	Länge gesamt Total Length cm
2254/240	9 x 6,5	24



Pfannenspachtel

starres Blatt aus gehärtetem Edelstahl 18/0,
zur vielseitigen Anwendung

Short Spatula

18/0 stainless steel, rigid tempered blade

Art-Nr. Part No.	Spatelmaß Blade cm	Länge gesamt Total Length cm
2252/065	10 x 6,5	26
2252/090	12 x 9	28
2252/100	12,5 x 10	30



Wender, flexibel

aus flexiblem Edelstahl 18/0

Cranked Turner

18/0 stainless steel, flexible blade

Art-Nr. Part No.	Spatelmaß Blade cm	Länge gesamt Total Length cm
2250/060	12 x 6	24
2250/080	12 x 8	24
2250/100	12 x 10	24



Bratenspachtel

mit starrem Blatt aus gehärtetem Edelstahl 18/0,
vielseitiges Utensil zum Reinigen, Abstechen, Glätten,
Wenden usw.

Griddle Scraper

rigid, tempered blade made of 18/0 stainless steel

Art-Nr. Part No.	Länge Length cm
2229/008	14



Schnitzmesser-Set, 8-teilig

Klingenlänge etwa 5 cm, mit einem Wetzstahl,
zum kreativen Garnieren und Dekorieren von Obst
und Gemüse, hochwertige Ausführung,
geliefert in Rolltasche

Garnishing Tools Set 8 piece

5 cm blades,
for creative garnishing of fruits and vegetables

Y-Querschäler

aus Edelstahl 18/10, glatter Klinge aus gehärtetem Messer Stahl, zum Schälen von Möhren, Kartoffeln, Rettich, Roter Beete, und anderem Gemüse

Speed Peeler

18/10 stainless steel, blade made from hardened stainless steel



Art-Nr. Part No.	Klingenbreite Blade Width cm	Länge Length cm
1073/009	9	15



Sparschäler

aus Edelstahl 18/10, mit beweglicher Klinge, für Links- und Rechtshänder

Peeler

18/10 stainless steel, movable blade, suitable for right and left handed



Art-Nr. Part No.	Länge Length cm
37/170	17,5



Spargelschäler

aus Edelstahl 18/10, seidenmatt poliert, mit beweglicher Klinge aus geschärftem und gehärtetem Edelstahl 18/0, mit verschiebbarem Arretierring zur platzsparenden, sicheren Lagerung

Asparagus Peeler

18/10 stainless steel, satin polished finish, with swivel peeler made of 18/0 stainless steel, with clip



Art-Nr. Part No.	Länge Length cm
2275/175	17,5



Pendelschäler

Serie POLARIS, mit seidenmatt poliertem Griff aus Edelstahl 18/10, Arbeitsteil aus Edelstahl 18/0, mit beweglicher Klinge, für Rechtshänder

Swivel Peeler

with hanging loop, handle 18/10 stainless steel, blade 18/0 stainless steel, satin polished



Art-Nr. Part No.	Länge Length cm	Klingenlänge Blade Length cm
922/185	18,5	5



Pendelschäler

Serie POLARIS, mit seidenmatt poliertem Griff aus Edelstahl 18/10, mit beweglicher Klinge aus Edelstahl 18/0

Swivel Peeler

with 18/10 stainless steel handle, 18/0 stainless steel flexible blade



Art-Nr. Part No.	Länge Length cm	Klingenlänge Blade Length cm
961/200	20	4



Sparschäler

Serie POLARIS, mit seidenmatt poliertem Griff aus Edelstahl 18/10, Arbeitsteil aus Edelstahl 18/0

Peeler

with hanging loop, handle 18/10 stainless steel, blade 18/0 stainless steel



Art-Nr. Part No.	Länge Length cm	Klingenlänge Blade Length cm
923/185	18,5	7



Gemüseschäler

Serie POLARIS, mit seidenmatt poliertem Griff aus Edelstahl 18/10 mit hochglänzender beweglicher Klinge aus Edelstahl 18/0, handliches formschönes Design

Speed Peeler

handle 18/10 stainless steel, mirror polished 18/0 stainless steel blade



Art-Nr. Part No.	Länge Length cm	Schneidbreite Cutting Width cm
998/180	16	4,5



Art-Nr. Part No.	Größe Size cm	Länge gesamt Total Length cm
931/160	3,5 x 2,5	17



Knoblauchpresse

Serie POLARIS, mit seidenmatt polierten Griffen aus Edelstahl 18/10, Arbeitsteil aus hochglänzendem Edelstahl 18/0, Einsatz herausnehmbar, 1,5 mm Lochung, schwere Qualität

Garlic Press

with hanging loops, handle 18/10 stainless steel, press 18/0 stainless steel, with removable insert, 1.5 mm perforations

Art-Nr. Part No.	Größe Size cm	Länge Length cm
1090/190	3,5 x 3,5	19



Knoblauchpresse

aus Aluminium, selbstreinigend durch Kunststoffknoppen, nicht spülmaschinengeeignet, 3 mm Lochung, robuste Qualität

Garlic Press

aluminium, self cleaning, not dishwasher proof, 3 mm perforations, heavy gauge

Art-Nr. Part No.	Länge Length cm
3737/175	17,5



Knoblauchpresse

aus PA mit PTFE-beschichtetem Aluminiumguss Drücker, mit patentiertem Verschlusssystem, welches das schnelle Reinigen des Arbeitsteils unter fließendem Wasser ermöglicht, spülmaschinengeeignet

Garlic Press

PA with PTFE non-stick coated cast aluminium press, patented design, which enables the press to be cleaned under running water, dishwasher safe

Art-Nr. Part No.	Länge Length cm	Schneidbreite Cutting Width cm	Breite Width cm
2270/215	21,5	3	5



Knoblauchhobel

aus Edelstahl 18/0, hochglänzend, Schiffchen mit Stopfen aus robustem ABS-Kunststoff zum Umstecken: eine Seite mit einer glatten Klinge zum Hobeln, andere Seite mit drei gezahnten Klingen zum Schreddern, mittelschwere Qualität

Garlic Slicer and Shredder

18/0 stainless steel, mirror polished finish, slider with stopper made of robust ABS, one side with a smooth blade for planing, other side with three serrated blades for shredding

Art-Nr. Part No.	Länge Length cm	Länge Length cm
---------------------	-----------------------	-----------------------

mit gewellter Klinge: / with scalloped blade

2277/160 17,5 cm 8,5 cm

mit glatter Klinge: / with plain blade

2277/170 17,5 cm 8,5 cm



Trüffel-/ Feinhobel

aus Edelstahl 18/0, hochglänzend, mit stufenloser Einstellschraube und extra scharfer Klinge, schwere Qualität

Truffle Mandolin

18/0 stainless steel, mirror polished finish, fully adjustable, extra sharp blade, can also be used for shaving chocolate

Art-Nr. Part No.	Ø dia. cm	Höhe Height cm	Klingenlänge Blade Length cm
2271/077	8,5	5	5,5



Spiralschneider

aus schwarzem ABS-Kunststoff, Klinge aus Messerstahl, miteinander verschweißt, zum Schneiden von Spiralen aus Möhren, Rettich, Äpfeln, Kohlrabi u.a., spülmaschinengeeignet

Spiral Cutter

black ABS plastic, hardened stainless steel blade, dishwasher safe

Apfelentkerner

Serie POLARIS, mit seidenmatt poliertem Griff aus Edelstahl 18/10, mit Aufhängeöse, schwere Qualität, Arbeitsteil aus Edelstahl 18/0, hochglänzend

Apple Corer

with hanging loop, handle 18/10 stainless steel, corer 18/0 stainless steel



Art-Nr. Part No.	Länge Length cm	Ø dia. cm
921/195	19,5	1,8

Apfelteiler

aus 1,2 mm starkem Edelstahl 18/10, hochglänzend, Klingen aus gehärtetem und geschärftem Messer Stahl, geeignet für Früchte bis 10 cm Durchmesser, spülmaschinenfest, schwere Qualität

Apple Divider

1.2 mm thick 18/10 stainless steel, mirror polished, extra sharpened steel blades, for fruits up to 10 cm diameter, dishwasher proof, heavy gauge



Art-Nr. Part No.	Ø innen Ø Inside cm	Höhe Height cm	Länge Length cm
2272/200	10	5	19,5

Dekorierschneider

aus beschichtetem Aluminiumguss, Klingen aus Edelstahl, spülmaschinengeeignet, ideal zur Herstellung für Radieschen-Rosetten, geeignet für Früchte mit max. Ø 40 mm

Garnishing Cutter

aluminium, blades stainless steel, dishwasher safe due to special plastic coating, for fruit and vegetables up to 40 mm Ø



Art-Nr. Part No.	Länge Length cm
4684/180	18 cm

Kartoffelspirale

aus Edelstahl 18/0, hochglänzend, 10 mm Ringdurchmesser

Potato Spiral Cutter

18/0 stainless steel, mirror polished finish, ring diameter 10 mm



Art-Nr. Part No.	Länge Length cm	Ø Draht Ø Wire mm
1164/240	24 cm	3,5 mm

Rettichschneider

Spiralschneider, aus geschärftem Edelstahl 18/0, Griff und Gewinde aus schwarzem Polypropylen, zur Herstellung dekorativer Spiralen aus Rettich, Zucchini oder Gurken

Radish Spiral Cutter

18/0 stainless steel, extra sharp, handle and spiral made of black polypropylene

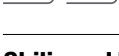

Art-Nr. Part No.	Länge Length cm

PRODUKTION
EINGESTELLT
PRODUCTION
DISCONTINUED

Chili- und Paprikaentkerner

aus Edelstahl 18/0, mit rotem ABS-Griff, zum Entkernen von Chilis, Paprikas und Jalapeños u.a.

Chilli / Pepper Knife

18/0 stainless steel, red ABS handle, for coring chillies and peppers



Art-Nr. Part No.	Länge Length cm	Klingenlänge Blade Length cm	Klingenbreite Blade Width cm
2268/210	21	10	2,3

Art-Nr. Part No.	Länge Length
4687/180	18 cm



Olivenentsteiner

aus beschichtetem Aluminiumguss, durch Beschichtung spülmaschineneeignet, hochqualitative Ausführung

Olive/Cherry Stoner

cast aluminium, dishwasher safe due to special plastic coating



Art-Nr. Part No.	Länge Length	Breite Width	∅ innen ∅ Inside
4692/060	13 cm	7 cm	5 cm



Pilzschneider

aus Zinkguss, verchromt, Sägemesser aus Edelstahl 18/0, schwere Qualität, schneidet Pilze in etwa 5 mm starke Scheiben

Mushroom Slicer

chrome plated zinc alloy, 18/0 stainless steel blades, heavy gauge, cuts mushrooms into 5 mm thick slices



Art-Nr. Part No.	Länge Length	Klingenbreite Blade Width	Höhe Height
1072/185	18,5 cm	5 cm	12,5 cm



Garnierschneider

aus Messer Stahl, mit lackiertem Holzgriff

Garnisher

18/0 stainless steel, with lacquered wooden handle



Art-Nr. Part No.	Breite Width	Höhe Height
2257/090	9,5 cm	7 cm



Wellenschneider

handgeschärfte Klinge aus Edelstahl, Griff aus schwarzem glasfaserverstärkten Polyamid, für Zickzack-Optik an festen Gemüse- und Obstsorten

Wavy Slicer

stainless steel, black fibreglass reinforced polyamide handle



Art-Nr. Part No.	Länge gesamt Total Length
2279/902	25 cm



Kugelausstecher

aus Edelstahl 18/10, hochglänzend, mit handlichem Hohlgriff, für Kugel Ø 26 und 31 mm, schwere Qualität

Melon Baller

18/10 stainless steel, mirror polished finish, 26 and 31 mm scoops, heavy gauge



Zitruspresse

aus Edelstahl 18/10, hochglänzend, zweiteilig

Citrus Squeezer

18/10 stainless steel, mirror polished finish, two piece

18/10
EDELSTAHL
STAINLESS STEEL



Art-Nr. Part No.	Fassungsvermögen Capacity	∅ innen ∅ Inside	Höhe Height
851/115	0,35 l	11,5 cm	10 cm

Zitronen-Segmentpresse

aus Edelstahl, hochglänzend, Pressschale mit 4 mm-Lochung, handlicher Griff, hiermit können dickere Stücke von Zitronen oder Limetten gepresst werden

Lemon Squeezer

stainless steel, mirror polished finish, 4 mm perforation

INOX
EDELSTAHL
STAINLESS STEEL



Art-Nr. Part No.	Länge Length	Breite max. Max. Width
817/170	17 cm	8 cm

Zitronenschnitzelpresse

aus Edelstahl 18/10, hochglänzend

Lemon Slice Squeezer

18/10 stainless steel, mirror polished finish

18/10
EDELSTAHL
STAINLESS STEEL



Art-Nr. Part No.	Länge Length	Breite Width
807/008	7,5 cm	7 cm

Zitronenschnitzelpresse

aus transparentem Acryl

Lemon Squeezer

transparent acrylic

ACRYL
ACRYLIC



Art-Nr. Part No.	Länge Length	Höhe Height
6754/120	12 cm	5 cm

Art-Nr. Part No.	Fläche Size cm	Länge gesamt Total Length cm
978/295	15 x 9	29,5
Scheibendicke: 7 mm		
Slices: 7 mm		



Tomatenschneider

Serie POLARIS, mit seidenmatt poliertem Griff aus Edelstahl 18/10, Sägen aus Edelstahl 18/0, ideal auch für Eier und Pilze

Tomato Slicer

handle 18/10 stainless steel, with hanging loop, 18/0 stainless steel serrated blades



Art-Nr. Part No.	Schneidbreite Cutting Width cm	Länge gesamt Total Length cm
4693/260	8,5 cm	26 cm
Scheibendicke: 5 mm		
Slices: 5 mm		



Pellkartoffelschneider

aus beschichtetem Aluminiumguss, spülmaschinengeeignet, einzeln gespannte Schneiddrähte aus Edelstahl, auch zum Schneiden von Mozzarella oder gekochtem Gemüse geeignet

Potato Slicer

coated cast aluminium, dishwasher safe, stainless steel wires, can be used for potatoes, mozzarella or cooked vegetables



Art-Nr. Part No.	∅ außen ∅ Outside cm	Höhe Height cm
1084/110	11 cm	3,5 cm
Scheibendicke: 4 mm		
Slices: 4 mm		



Eierschneider

aus Aluminium, zum Längs- und Querteilen hartgekochter Eier, nicht spülmaschinengeeignet

Egg Slicer

cast aluminium, not dishwasher proof



Art-Nr. Part No.	Länge Length cm	Breite Width cm	Höhe Height cm
4694/130	13	9	3,5
Scheibendicke: 4,5 mm			
Slices: 4.5 mm			



Eierschneider

aus Polypropylen, Drähte aus Edelstahl 18/10, stabile Qualität, das Ei kann auch um 90° gedreht werden um einen Querschnitt zu erhalten, spülmaschinengeeignet

Egg Slicer

green polypropylene, 18/10 stainless steel wires, sturdy quality, works length and width wise



Art-Nr. Part No.	Länge Length cm	Breite Width cm
4696/130	14,5 cm	8 cm
Scheibendicke: 6 mm		
Slices: 6 mm		



Eierschneider

aus leichtem Edelstahl 18/0 mit Drähten aus Edelstahl 18/10, zum Längs- und Querteilen hartgekochter Eier, spülmaschinengeeignet

Egg Slicer

18/0 stainless steel, wires 18/10 stainless steel, dishwasher proof



Art-Nr. Part No.	Länge Length cm	Breite Width cm
4697/125	12,5 cm	8 cm
Scheibendicke: 5 mm		
Slices: 5 mm		



Eierschneider

aus beschichtetem Aluminiumguss, Schneiddrähte aus Edelstahl 18/10, durch silberfarbene Beschichtung spülmaschinengeeignet, hochqualitative Ausführung, zum Längs- und Querteilen hartgekochter Eier

Egg Slicer

cast aluminium, wires 18/10 stainless steel, silver coloured coating, dishwasher proof



Eierstückler

aus Edelstahl 18/10, hochglänzend, Drähte aus Edelstahl 18/10, spülmaschinene geeignet, mit handlicher Verschlussmechanik, schwere Qualität

Egg Divider

18/10 stainless steel, mirror polished, 18/10 stainless steel wires, dishwasher proof, heavy gauge



Art-Nr. Part No.	Länge Length
272/180	18 cm

Eierstückler

aus Aluminiumguss, durch silberfarbene Spezialbeschichtung spülmaschinene geeignet, Drähte aus 18/10

Egg Divider

cast aluminium, with food safe silver plastic coating, 18/10 stainless steel wires, dishwasher proof



Art-Nr. Part No.	Länge Length
4691/180	18 cm

Eiertrenner

Serie POLARIS, aus hochglänzendem Edelstahl 18/0, mit Griff aus Edelstahl 18/10, trennt schonend und sicher Eidotter von Eiweiß

Egg Separator

with hanging loop, handle 18/10 stainless steel, separator 18/0 stainless steel



Art-Nr. Part No.	Länge Length	Ø dia. cm
993/210	21	7

Eierring

aus Edelstahl 18/0, mit schwenkbarem Griff und Aufhänge Loch

Egg Ring

18/0 stainless steel, with moveable handle



Art-Nr. Part No.	Ø dia. cm	Höhe Height cm	Stiellänge Handle Length cm
270/085	8,5	1,5	8

Eier-/Omelettering

aus Edelstahl 18/10

Egg Ring

18/10 stainless steel



Art-Nr. Part No.	Ø dia. cm	Höhe Height cm	Stiellänge Handle Length cm
271/085	8,5	2,5	7
271/125	12,5	2,5	11

Eierköpfer

aus Edelstahl 18/10, hochglänzend, schwere Qualität

Egg Topper

18/10 stainless steel, mirror polished finish, heavy gauge



Art-Nr. Part No.	Ø innen Ø Inside cm	Breite Width cm
273/090	3,5	9

Eierstecher

aus Edelstahl, hochglänzend, auf schwarzem Fuß, verhindert das Aufbrechen der Eischale beim Kochen

Egg Pick

stainless steel, mirror polished finish, with black base, designed to prevent eggs from cracking when boiling



Art-Nr. Part No.	Ø dia. cm	Höhe Height cm
45/055	5,5	3,5

Art-Nr. Part No.	Länge Length cm	Breite Width cm	
für kurze Knöpfle: / for short Knöpfle			
1091/460	45,5	15,5	2 l
für lange Spätzle / for long Spätzle			
1091/462	45,5	15,5	2 l



Spätzle-/ Knöpflehobel, groß
aus Edelstahl 18/10, mit halber/voller 7 mm Lochung, mit Topfhalterung, mit Ruhebereich zum Befüllen des Schlittens, für Kochtöpfe von Ø 36 bis 45 cm, schwere Qualität

Large Spätzle Slicer
18/10 stainless steel, half/full 7 mm holes, pot holder, for 36 to 45 cm diameter pots, heavy gauge



Art-Nr. Part No.	Länge Length cm	Ø dia. cm	
Für kurze Knöpfle: / For short Knöpfle:			
560/001	37,5	8,5	0,4 l
Für lange Spätzle: / For long Spätzle:			
560/002	37,5	8,5	0,4 l



Spätzlepresse
beschichteter Aluminiumguss, lebensmittelecht, spülmaschinengeeignet durch Spezialbeschichtung

Spätzle/Noodle Press
cast aluminium, special coating, ergonomically shaped dishwasher proof



Art-Nr. Part No.	Länge Length cm	Ø dia. cm	
1336/360	31,5	8	0,35 l



Spätzle- und Kartoffelpresse
aus Edelstahl 18/10, matt poliert, mit drei auswechselbaren Einsätzen, zur Herstellung von Kartoffelpüree, Spätzle usw., spülmaschinengeeignet

Spätzle and Potato Ricer
18/10 stainless steel, matt polished finish, with three different discs, dishwasher proof



Art-Nr. Part No.	Länge Length	Breite Width
PRODUKTION EINGESTELLT PRODUCTION DISCONTINUED		



Spätzlehebel
aus Edelstahl 18/0, hochglänzend poliert, Führung aus schwarzem Kunststoff, halbrunde Lochung für lange schwäbische Spätzle, für Topfdurchmesser von 20 bis 28 cm geeignet

Spätzle/Noodle Slicer
18/0 stainless steel, mirror polished finish, oblong perforations for long Swabian spätzle, suits pot diameter 20 to 28 cm



Art-Nr. Part No.	Länge Length	Breite Width
1095/330	33 cm	11 cm



Spätzlehebel
aus Edelstahl 18/0, Führung aus schwarzem Kunststoff, matt poliert, runde Lochung für kurze bayrische Knöpfle, für Topfdurchmesser von 20 bis 28 cm geeignet

Spätzle/Pasta Slicer
18/0 stainless steel, matt polished finish, round perforations for short, Bavarian spätzle, suits pot diameter 20 to 28 cm



Art-Nr. Part No.	Ø außen Ø Outside	Höhe Height
561/270	27 cm	2 cm

Abmessung ohne Griffe.
Measurements without handles.



Spätzlesieb
aus Edelstahl 18/0, hochglänzend, Lochdurchmesser 5 mm, mit Kunststoffspachtel, für Topfdurchmesser von 24 bis 28 cm geeignet

Spätzle Plate
18/0 stainless steel mirror polished finish, 5 mm perforations, suits pot diameter 24 to 28 cm



Kartoffelpresse

aus Edelstahl 18/10, mit 2,5 mm-Lochung, kreuzgerändelter griffiger Hebel, extra schwere Ausführung mit zusätzlichen Verstärkungsstreben

Potato Ricer

18/10 stainless steel, 2.5 mm perforation, extra heavy gauge



Art-Nr. Part No.	Größe Size cm	Länge gesamt Total Length cm	
1380/330	10,5 x 10,5	33	0,65 l
1380/337	Ersatzhaltestift / Spare pin		

18/10
EDELSTAHL
STAINLESS STEEL

Kartoffelstampfer

Serie POLARIS, seidenmatt polierter Griff, ganz aus Edelstahl 18/10, Materialstärke 1,5 mm, hochglänzend, schwere Qualität

Potato Masher

all 18/10 stainless steel with hanging loop, mirror polished with satin polished handle, 1.5 mm masher



Art-Nr. Part No.	Fläche Size cm	Länge Length cm
981/235	7 x 8,5	23,5

18/10
EDELSTAHL
STAINLESS STEEL

Kartoffelstampfer

Serie POLARIS, mit Aufhängeschlaufe, schwere Qualität, ganz aus Edelstahl 18/10, 4 mm Drahtstärke

Potato Masher

all 18/10 stainless steel with hanging loop, mirror polished with satin polished handle, 4 mm wire



Art-Nr. Part No.	Fläche Size cm	Länge Length cm
980/250	10 x 7	29,5

18/10
EDELSTAHL
STAINLESS STEEL

Kartoffelstampfer

ganz aus Edelstahl 18/10, Stieldicke 3 cm, Drahtdicke 5 mm, durch Spezialabdichtung absolut wasserdicht, extra schwere Qualität für extremste Belastungen

Potato Masher

18/10 stainless steel, handle Ø 3 cm, 5 mm masher, extra heavy gauge



Art-Nr. Part No.	Fläche Size cm	Länge Length cm
918/500	15,5 x 8,3	50
918/800	15,2 x 8,3	80

18/10
EDELSTAHL
STAINLESS STEEL

Kartoffelstampfer

ganz aus Edelstahl 18/10, mit 25 mm Rohrgriff und 6 mm starkem Draht

Potato Masher

18/10 stainless steel, 25 mm tubular handle and 6 mm thick wire



Art-Nr. Part No.	Fläche Size cm	Länge gesamt Total Length cm
2058/600	15 x 13	62

18/10
EDELSTAHL
STAINLESS STEEL

Rührbesen, Kellen & Schaufeln

Schöpfen, gießen, servieren, sieben, passieren, blanchieren, frittieren - all das und noch viel mehr - mit den Küchenhelfern von **contacto**

Whisks, Ladles & Scoops

Beat, ladle and skim - all this and much more - with these kitchen gadgets from **contacto**.

Art-Nr. Part No.	Länge Length cm	Ø Draht Ø Wire mm	Stiellänge Handle Length cm
826/250	25	2,2	13
826/300	30	2,2	13

Mit Verstärkungsschlaufe: / With reinforcing loop:

826/350	36	2,2	13
826/400	41	2,2	13
826/450	45	2,2	13
826/500	50	2,2	13
826/550	55	2,2	16
826/600	60	2,2	16

Art-Nr. Part No.	Länge Length cm	Ø Draht Ø Wire mm	Stiellänge Handle Length cm
911/230	24	2	10
911/270	28	2	10
911/300	31	2	10
911/350	35	2	10

Mit Verstärkungsring: / With reinforcing ring:

911/400	40	2,5	11
911/500	50	2,5	19,5
911/600	60	2,5	20

Art-Nr. Part No.	Länge Length cm	Ø Draht Ø Wire mm	Stiellänge Handle Length cm
820/300	33	2,4	13

Mit Verstärkungsschlaufe: / With reinforcing loop:

820/350	38,5	2,4	13
820/400	43,5	2,4	13

Art-Nr. Part No.	Länge gesamt Total Length cm	Ø Draht Ø Wire mm	Stiellänge Handle Length cm
821/250	25	1,5	12
821/300	30	1,5	12
821/350	35	2	14
821/400	40	2	14
821/450	45	2	22



Rührbesen

16 dicke Drähte, aus Edelstahl 18/10, ohne Aufhängeschlaufe, absolut wasserdicht, schwere Qualität

Heavy Whisk

8 thick wires, 18/10 stainless steel, watertight seal, heavy gauge



Rührbesen

10 dicke Drähte, aus Edelstahl 18/10, mit Aufhängeschlaufe, Stieldicke 2 cm, durch Spezialabdichtung absolut wasserdicht, extra schwere Qualität

Heavy Whisk

5 thick wires, 18/10 stainless steel, handle Ø 20 mm with hanging loop, watertight seal, extra heavy gauge



Rührbesen

16 dicke Drähte, aus Edelstahl 18/10, mit Aufhängeschlaufe, absolut wasserdicht, schwere Qualität

Heavy Whisk

8 thick wires, 18/10 stainless steel, handle with hanging loop, watertight seal, heavy gauge



Rührbesen

16 dicke Drähte, aus Edelstahl 18/10, ohne Aufhängeschlaufe, rutschhemmender, thermoplastischer, abriebfester Griff, die achteckige Formgebung ermöglicht handliches, ermüdungsfreies Rühren, spülmaschineneeignet, schwere Qualität

Whisk

8 thick wires, 18/10 stainless steel, octagonal thermoplastic non slip handle, dishwasher safe, high quality



Rührbesen

16 dicke Drähte, mit Effizienz steigernden Zusatzschlaufen, aus Edelstahl 18/10, mit Aufhängeschleufe, absolut wasserdicht

Whisk

8 thick wires with rings to increase effectiveness, 18/10 stainless steel, handle with hanging loop, watertight seal

18/10
EDELSTAHL
STAINLESS STEEL



Art-Nr. Part No.	Länge Length cm	Ø Draht Ø Wire mm	Stiellänge Handle Length cm
827/280	28	2,0	17
827/350	35	2,0	17
827/450	45	2,0	17

Rührbesen

10 extra dicke Drähte, ganz aus Edelstahl 18/10, mit Aufhänger, Stieldicke 3 cm, geeignet zum Einspannen in Rührmaschinen, Spezialabdichtung absolut wasserdicht, extra schwere Qualität für extremste Belastungen

Large Heavy Whisk

5 extra thick wires, 18/10 stainless steel, handle Ø 30 mm, watertight seal, extra heavy gauge

18/10
EDELSTAHL
STAINLESS STEEL



Art-Nr. Part No.	Länge Length cm	Ø Draht Ø Wire mm	Stiellänge Handle Length cm	Ø max. cm
917/060	63	2,8	34	12,5
917/070	71	2,8	38	13
917/080	80	2,8	44	15,5
917/100	100	3,8	60	18
917/125	125	3,8	85	18,5
917/150	150	3,8	107,5	17
917/180*	180	3,8	142	18

*Versand dieser Größe nur per Spedition möglich.

*For this size pallet delivery only.

Kesselbesen

20 dicke Drähte, bauchige Form, Drähte und Stiel aus Edelstahl 18/10, Stieldicke 3 cm, mit Aufhängeöse, durch Spezialabdichtung absolut wasserdicht, extra schwere Qualität für extremste Belastungen

Large Heavy Whisk

10 thick wires, handle Ø 30 mm, 18/10 stainless steel, watertight seal, extra heavy gauge

18/10
EDELSTAHL
STAINLESS STEEL



Art-Nr. Part No.	Länge Length cm	Ø Draht Ø Wire mm	Stiellänge Handle Length cm	Ø max. cm
913/100	115	2,5	85	13,5
913/145	145	3	110	16

Schneebesen

24 dünne Drähte, aus Edelstahl 18/10, ohne Aufhängeschleufe, absolut wasserdicht, schwere Qualität

Whisk

12 piano wires, 18/10 stainless steel, watertight seal, heavy gauge

18/10
EDELSTAHL
STAINLESS STEEL



Art-Nr. Part No.	Länge Length cm	Ø Draht Ø Wire mm	Stiellänge Handle Length cm
834/250	26	1,3	13
834/300	30	1,3	13
834/350	35	1,3	13
834/400	40	1,3	16
834/450	45	1,3	16
834/500	50	1,3	16

Schneebesen

24 dünne Drähte, aus Edelstahl 18/10, mit Aufhängeschleufe, absolut wasserdicht, schwere Qualität

Whisk

12 piano wires, 18/10 stainless steel, handle with hanging loop, watertight seal, heavy gauge

18/10
EDELSTAHL
STAINLESS STEEL



Art-Nr. Part No.	Länge Length cm	Ø Draht Ø Wire mm	Stiellänge Handle Length cm
830/250	28	1,3	11
830/300	33	1,3	11
830/350	38	1,3	11
830/400	43	1,3	11

Schneebesen

14 dünne Drähte, aus Edelstahl 18/10, ohne Aufhängeschleufe

Whisk

7 piano wires, 18/10 stainless steel

18/10
EDELSTAHL
STAINLESS STEEL



Art-Nr. Part No.	Länge Length cm	Ø Draht Ø Wire mm	Stiellänge Handle Length cm
835/200	20	1,3	10
835/250	25	1,3	11,5
835/300	30	1,3	13



Art-Nr. Part No.	Länge Length cm	∅ Draht ∅ Wire mm
949/200	22,5	1,4
949/250	27	1,4
949/300	32	1,4



Schneebeesen

Serie POLARIS, 14 dünne Drähte, mit Aufhängeschlaufe, ganz aus Edelstahl 18/10

Whisk

7 piano wires, with hanging loop, all 18/10 stainless steel



Art-Nr. Part No.	Länge Length cm
951/300	30



Kugelschneebeesen

aus Edelstahl, mit Aufhängeöse, zehn an den Drahtenden befestigte Kugeln erzeugen durch die Schwingungen hohe Quirlleistungen

Whisk

stainless steel, with hanging loop, ten balls attached to the wire produce effective thorough mixing



Art-Nr. Part No.	Länge Length cm	∅ Draht ∅ Wire mm
907/310	31	4



Rührbesen, Polyamid

Serie POLARIS, mit Griff aus Edelstahl 18/10, Drähte aus Polyamid hitzeresistent bis +220°C, ideal für beschichtete Pfannen und Sauteusen

Whisk

handle 18/10 stainless steel, polyamide head heat resistant up to +220°C



Art-Nr. Part No.	Länge Length cm	∅ Draht ∅ Wire mm
940/210	21,5	1,4
940/260	26	1,4



Tellerschneebeesen

Serie POLARIS, 8 dünne Drähte, mit Aufhängeschlaufe, schwere Qualität, ganz aus Edelstahl 18/10

Flat Whisk

4 piano wires, with hanging loop, all 18/10 stainless steel



Art-Nr. Part No.	Länge Length cm
900/250	29



Spiralbesen

ganz aus Edelstahl 18/10, robuste Qualität

Egg Whisk

all 18/10 stainless steel, robust quality



Art-Nr. Part No.	Länge Length cm
828/200	20



Mini-Spiralbesen

aus Edelstahl, mit Aufhängeöse, optimal zum Zubereiten von kleinsten Mengen feiner Saucen und Eiern, ideal auch als Cocktail-Rührbesen

Mini Whisk

stainless steel, with hanging loop



Schöpfkelle, fugenlos

aus Edelstahl 18/10, Kelle hochglänzend, Griff seidmatt poliert, Maßstempelung auf Stiel mit Ø und Volumenangabe, schwere Qualität

Ladle

18/10 stainless steel, bowl mirror and handle satin polished finish, one piece, capacity and diameter stamped on handle, heavy gauge

18/10
EDELSTAHL
STAINLESS STEEL



Art-Nr. Part No.	Ø dia. cm	Stiellänge Handle Length cm	
82/050	0,03 l	5	30
82/060	0,06 l	6	30
82/070	0,08 l	7	32
82/080	0,125 l	8	34
82/090	0,2 l	9	36
82/100	0,25 l	10	38
82/110	0,33 l	11	42
82/120	0,5 l	12	42
82/140	0,75 l	14	43
82/160	1 l	16	47
82/180	1,5 l	18	49
82/200*	2 l	20	55

*Diese Größe mit angesetztem Stiel.

*This size with spot welded handle.

Schöpfkelle, kurz, fugenlos

mit kurzem Stiel, aus Edelstahl 18/10, hochglänzend poliert, Stempelung auf Stiel mit Ø und Volumenangabe, schwere Qualität

Ladle, short handle

18/10 stainless steel, mirror polished finish, one piece, capacity and diameter stamped on handle, heavy gauge

18/10
EDELSTAHL
STAINLESS STEEL



Art-Nr. Part No.	Ø dia. cm	Stiellänge Handle Length cm	
81/070	0,08 l	7	22
81/080	0,125 l	8	22
81/090	0,2 l	9	24
81/100	0,25 l	10	24
81/120	0,5 l	12	26

Schöpfkelle, fugenlos

aus Edelstahl 18/10, hochglänzend, Maßstempelung auf Stiel mit Ø und Volumenangabe, schwere Qualität

Ladle

18/10 stainless steel, mirror polished finish, one piece, capacity and diameter stamped on handle, heavy gauge

18/10
EDELSTAHL
STAINLESS STEEL



Art-Nr. Part No.	Ø dia. cm	Stiellänge Handle Length cm	
920/040	0,02 l	4	19,5
920/045	0,025 l	4,5	22
920/050	0,03 l	5	22
920/060	0,06 l	6	23
920/065	0,07 l	6,5	23
920/070	0,08 l	7	29
920/080	0,125 l	8	32
920/090	0,2 l	9	33
920/100	0,25 l	10	36
920/110	0,33 l	11	38
920/120	0,5 l	12	40
920/140	0,75 l	14	41
920/160	1 l	16	45
920/180	1,5 l	18	47
920/200*	2 l	20	42,5

*Diese Größe mit angesetztem Stiel.

*This size with spot welded handle.

Schöpfkelle, fugenlos

aus Edelstahl 18/10, hochglänzend poliert, mit Schüttrand, mit extra breitem, seidmatt poliertem Stiel (Materialstärke siehe Tabelle), Maßstempelung auf Stiel mit Ø und Volumenangabe, schwere Qualität

Ladle

18/10 stainless steel, mirror polished finish, one piece, with extra wide satin polished finish handle (see table for material thickness), diameter and capacity stamped on handle, heavy gauge

18/10
EDELSTAHL
STAINLESS STEEL



Art-Nr. Part No.	Ø innen Ø Inside cm	Stiellänge Handle Length cm	Stärke Thickness mm	
80/050	0,03 l	5	27	3,5
80/060	0,05 l	6	29	3,5
80/070	0,08 l	7	30	3,5
80/080	0,125 l	8	32	3,5
80/090	0,15 l	9	33,5	3,5
80/100	0,25 l	10	35	3,5
80/110	0,3 l	11	36	4,0
80/120	0,35 l	12	36,5	4,0
80/140	0,55 l	14	37	4,0

Art-Nr. Part No.	∅ dia. cm	Stiellänge Handle Length cm
83/240	3,5 l	25



Schöpfkelle mit Holzstiel

aus Edelstahl 18/10, hochglänzend poliert, fugenlos verschweißt, mit 3 cm dickem Birkenholzstiel, schwere Qualität

Large Ladle

18/10 stainless steel, mirror polished finish, seamless welded, with birchwood handle Ø 30 mm, heavy gauge



Art-Nr. Part No.	∅ dia. cm	Stiellänge Handle Length cm
84/200	2 l	20
84/240	4 l	24



Schöpfkelle, groß

aus Edelstahl 18/10, hochglänzend poliert, mit fugenlos verschweißtem Rundstiel (Ø 30 mm) aus Edelstahl, schwere Qualität

Large Ladle

18/10 stainless steel, mirror polished finish, one piece, stainless steel round handle Ø 30 mm, heavy gauge



Art-Nr. Part No.	Löffelmaß Bowl Size cm	Stiellänge Handle Length cm
1881/090	0,1 l	9,8 x 9,8



Schöpfkelle

aus Edelstahl, fugenlos, hochglänzend, mit Hakengriff, ohne Maßstempelung, schwere Qualität

Soup Ladle

stainless steel, mirror polished finish, one piece, heavy gauge



Art-Nr. Part No.	∅ dia. cm	Stiellänge Handle Length cm
7785/070	0,06 l	7
7785/090	0,1 l	9



Schöpfkelle

Serie ERGONOM, aus Edelstahl 18/0, hochglänzend, ergonomisch profilierter Griff aus Edelstahl 18/10, fugenlos

Soup Ladle

18/10 stainless steel handle, ergonomically designed, one piece, 18/0 stainless steel bowl, mirror polished finish



Art-Nr. Part No.	∅ dia. cm	Stiellänge Handle Length cm
97/060	0,04 l	6
97/080	0,15 l	8
97/100	0,2 l	10
97/120	0,3 l	12



Schöpfkelle, leicht

aus Edelstahl, fugenlos, ohne Maßstempel, Griff mit Haken, leichte Qualität

Ladle

stainless steel, one piece, handle with hook, economy



Art-Nr. Part No.	Löffelmaß Bowl Size cm	Stiellänge Handle Length cm
960/300	0,06 l	6 x 7
960/320	0,1 l	8 x 9



Schöpfkelle, oval

Serie POLARIS, seidenmatt polierter Griff, ganz aus Edelstahl 18/10, hochglänzend

Soup Ladle

with hanging loop, mirror polished with satin polished handle, all 18/10 stainless steel



Suppenschöpfer

Serie BUFFET NOIR, mit Griff aus schwarzem Polyamid, Kelle aus Edelstahl, leicht dreieckige Kellenform, temperaturbeständig bis +120°C, spülmaschinengeeignet

Soup Ladle

BUFFET NOIR range, stainless steel, with black polyamide handle, heat resistant up to +120°C, dishwasher safe



Art-Nr. Part No.	Löffelmaß Bowl Size cm	Länge gesamt Total Length cm	
8941/340	9 x 8,5	34	0,1 l

Bouillonkelle

aus Edelstahl 18/10, extra flach, fugenlos, hochglänzend, mit Hakengriff, schwere Qualität

Shallow Soup Ladle

18/10 stainless steel, mirror polished finish, one piece, handle with hook, heavy gauge



Art-Nr. Part No.		Ø dia. cm	Stiellänge Handle Length cm
1815/100	0,12 l	10	24

Servierkelle, fugenlos

aus Edelstahl 18/10, hochglänzend, mit zwei Ausguss-schnäupen, mit Hakengriff, schwere Qualität

Tasting/Sauce Ladle

18/10 stainless steel, mirror polished finish, one piece, with two pouring lips, handle with hook, heavy gauge



Art-Nr. Part No.		Ø dia. cm	Stiellänge Handle Length cm
1818/045	0,02 l	4,5	22
1818/050	0,03 l	5	22
1818/060	0,06 l	6	23
1818/065	0,07 l	6,5	23
1818/070	0,08 l	7	29
1818/080	0,125 l	8	32
1818/090	0,2 l	9	32

Weitere Größen auf Anfrage.
Further sizes on request.

Dressingschöpfer, fugenlos

aus Edelstahl 18/10, hochglänzend, mit zwei Ausguss-schnäupen, Stiel im 90° Winkel angesetzt, mit Hakengriff, schwere Qualität

Dressing/Sauce Ladle

18/10 stainless steel, mirror polished finish, one piece, with two pouring lips, handle with hook, heavy gauge



Art-Nr. Part No.		Ø dia. cm	Stiellänge Handle Length cm
1819/045	0,02 l	4,5	22
1819/050	0,03 l	5	22
1819/065	0,06 l	6,5	23

Weitere Größen auf Anfrage.
Further sizes on request.

Dressingschöpfer, fugenlos

aus Edelstahl 18/10, hochglänzend, mit zwei Ausguss-schnäupen, mit extra langem im 90° Winkel angebrachten Stiel, schwere Qualität

Dressing/Sauce Ladle

long handle, 18/10 stainless steel, mirror polished finish, one piece, with two pouring lips, heavy gauge



Art-Nr. Part No.		Ø dia. cm	Stiellänge Handle Length cm
1816/065	0,06 l	6,5	36

Dressinglöffel

Serie BUFFET ONE, aus Edelstahl 18/10, fugenlos, hochglänzend polierte Laffe, seidenmatt polierter, im 90° Winkel angebrachter Stiel

Dressing Ladle

BUFFET ONE range, 18/10 stainless steel, one piece, mirror polished, satin polished angled handle



Art-Nr. Part No.	Ø dia. cm	Stiellänge Handle Length cm	
3354/335	4,5	30	0,03 l



Art-Nr. Part No.	∅ dia.	Stiellänge Handle Length
72/080	8 cm	28 cm
72/100	10 cm	32 cm
72/120	12 cm	36 cm
72/140	14 cm	40 cm
72/160	16 cm	43 cm
72/180	18 cm	44 cm
72/200	20 cm	47 cm



Schaumlöffel, fugenlos

aus Edelstahl 18/10, hochglänzend poliert, flache Form, mit 4 mm Lochung, Griff mit Haken, schwere Qualität

Skimmer

18/10 stainless steel, mirror polished finish, one piece, with 4 mm perforation, handle with hook, heavy gauge



Art-Nr. Part No.	∅ dia.	Stiellänge Handle Length
73/060	6 cm	22 cm
73/080	8 cm	22 cm
73/100	10 cm	22 cm
73/120	12 cm	25 cm
73/140	14 cm	25 cm



Schaumlöffel, kurz, fugenlos

aus Edelstahl 18/10, hochglänzend poliert, flache Form, mit kurzem Stiel, mit 4 mm Lochung, Griff mit Haken, extra schwere Qualität

Skimmer

short handle, 18/10 stainless steel, mirror polished finish, one piece, with 4 mm perforation, handle with hook, extra heavy gauge



Art-Nr. Part No.	∅ dia.	Stiellänge Handle Length
70/080	8 cm	32,5 cm
70/100	10 cm	33 cm
70/120	12 cm	38 cm
70/140	14 cm	40,5 cm
70/160	16 cm	42 cm
70/180	18 cm	42,5 cm
70/200	20 cm	44 cm



Schaumlöffel, fugenlos

aus Edelstahl 18/10, hochglänzend poliert, flache Form, mit extra breitem, seidenmatt poliertem Stiel (Materialstärke: 3,5 mm), mit 4 mm Lochung, extra schwere Qualität

Skimmer

18/10 stainless steel, mirror polished finish, with extra wide satin polished finish handle, material thickness: 3.5 mm with 4 mm perforation, one piece, extra heavy gauge



Art-Nr. Part No.	∅ dia.	Stiellänge Handle Length
74/250	25 cm	92 cm



Schaumlöffel, groß

aus Edelstahl 18/10, flache Form, mit angesetztem Rohrstiel aus Edelstahl, mit 3,5 mm Lochung, schwere Qualität

Large Skimmer

18/10 stainless steel, two piece, stainless steel tubular handle, with 3.5 mm perforation, heavy gauge



Art-Nr. Part No.	∅ dia. cm	Stiellänge Handle Length cm	
75/070	0,08 l	7	29
75/080	0,125 l	8	32
75/090	0,2 l	9	33
75/100	0,25 l	10	37
75/120	0,5 l	12	40
75/140	0,75 l	14	41
75/160	1 l	16	45



Schaumkelle, fugenlos

aus Edelstahl 18/10, hochglänzend poliert, tiefe Form, 5 mm Perforierung, schwere Qualität

Perforated Ladle

18/10 stainless steel, mirror polished finish, one piece, capacity stamped on handle, 5 mm perforation, heavy gauge



Schaumkelle, kurz, fugenlos

mit kurzem Stiel, aus Edelstahl 18/10, hochglänzend poliert, tiefe Form, 5 mm Perforierung, schwere Qualität

Perforated Ladle

short handle, 18/10 stainless steel, mirror polished finish, one piece, capacity stamped on handle, 5 mm perforation, heavy gauge



Art-Nr. Part No.		Ø dia. cm	Stiellänge Handle Length cm
87/100	0,25 l	10	24
87/120	0,5 l	12	24

Seihlöffel, perforiert, längs

aus Edelstahl 18/10, hochglänzend, fugenlos, mit 4 mm Lochung, schwere Qualität

Perforated Basting Spoon

18/10 stainless steel, mirror polished finish, one piece, with 4 mm perforation, heavy gauge



Art-Nr. Part No.	Löffelmaß Bowl Size cm	Stiellänge Handle Length cm	
5601/110	10 x 7	37	0,075 l

Fisch-/ Schaumlöffel, oval

Serie POLARIS, seidenmatt polierter Griff, ganz aus Edelstahl 18/10, hochglänzend

Oval Skimmer / Fish Lifter

with hanging loop, mirror polished with satin polished handle, all 18/10 stainless steel



Art-Nr. Part No.	Löffelmaß Bowl Size cm	Länge gesamt Total Length cm
970/350	11 x 10	33

Schaumlöffel, rund

Serie POLARIS, mit seidenmatt poliertem Griff aus Edelstahl 18/10, Löffel aus Edelstahl 18/0, hochglänzend

Skimmer

with hanging loop, handle 18/10 stainless steel, satin polished, bowl 18/0 stainless steel mirror polished



Art-Nr. Part No.	Ø dia. cm	Länge gesamt Total Length cm
969/350	11	35

Siebschaufel, groß

Serie POLARIS, mit seidenmatt poliertem Griff aus Edelstahl, Arbeitsteil aus Polyamid, hitzebeständig bis +220°C

Perforated Scoop

polyamide, with stainless steel handle and hanging loop, heat resistant up to +220°C



Art-Nr. Part No.	Länge Length cm	Ø dia. cm

PRODUKTION
EINGESTELLT
PRODUCTION
DISCONTINUED



Art-Nr. Part No.	Löffelmaß Bowl Size cm	Stiellänge Handle Length cm	
35/110	10 x 7	37	0,075 l



Gießlöffel, längs

aus Edelstahl 18/10, hochglänzend, fugenlos, schwere Qualität

Basting Spoon

18/10 stainless steel, mirror polished finish, one piece, heavy gauge



Art-Nr. Part No.	Löffelmaß Bowl Size cm	Stiellänge Handle Length cm	
25/110	7 x 10	37	0,075 l

Ausführung für Rechtshänder: / Right handed:



Gießlöffel, quer

aus Edelstahl 18/10, fugenlos, hochglänzend, schwere Qualität

Gravy Spoon

18/10 stainless steel, mirror polished finish, one piece, heavy gauge



Art-Nr. Part No.	Löffelmaß Bowl Size cm	Stiellänge Handle Length cm	
5603/370	7 x 10	37	0,075 l

Ausführung für Linkshänder: / Left handed:

Art-Nr. Part No.	Löffelmaß Bowl Size cm	Stiellänge Handle Length cm	
1814/060	8 x 6	22	0,04 l



Saucenkelle, fugenlos

aus Edelstahl 18/10, hochglänzend, beidseitige Ausgusschnaupe, schwere Qualität

Shallow Sauce Ladle

18/10 stainless steel, mirror polished finish, with two pouring lips, heavy gauge



Art-Nr. Part No.	Länge Length cm	Ø dia. cm	
3357/210	20,5	6	0,025 l



Saucenkelle

Serie BUFFET ONE, aus Edelstahl 18/10, fugenlos, beidseitige Ausgusschnaupe, hochglänzend polierte Laffe, seidenmatt polierter, angewinkelter Stiel

Sauce Ladle

BUFFET ONE range, 18/10 stainless steel, one piece, with two pouring lips, mirror polished, satin polished angled handle



Art-Nr. Part No.	Löffelmaß Bowl Size cm	Stiellänge Handle Length cm	
1811/220	7,5 x 4,5	22	0,03 l



Saucengießlöffel, fugenlos

aus Edelstahl 18/10, hochglänzend, mit einseitiger Ausgusschnaupe, schwere Qualität

Sauce/Gravy Ladle

18/10 stainless steel, mirror polished finish, with one pouring lip, heavy gauge



Art-Nr. Part No.	Löffelmaß Bowl Size cm	Stiellänge Handle Length cm	
974/280	7 x 5	21	0,02 l



Saucengießlöffel

Serie POLARIS, seidenmatt polierter Griff, ganz aus Edelstahl 18/10, mit einseitiger Ausgusschnaupe, hochglänzend

Sauce/Gravy Ladle

with hanging loop, satin polished handle, with one pouring lip, all 18/10 stainless steel



Art-Nr. Part No.	Löffelmaß Bowl Size cm	Stiellänge Handle Length cm	
7790/290	7 x 5,5	22	0,02 l



Saucengießlöffel

Serie ERGONOM, aus Edelstahl 18/0, hochglänzend, ergonomisch profilierter Griff aus Edelstahl 18/10, mit einseitiger Ausgusschnaupe, fugenlos

Sauce/Gravy Ladle

18/10 stainless steel handle, 18/0 stainless steel bowl, mirror polished finish, with one pouring lip



Frittierlöffel

rund, aus Edelstahl, hochglänzend elektroploliert,
Gitternetz mit 4,5 x 4,5 mm Maschenweite,
sehr stabile Ausführung

Skimmer/ Spider

round, stainless steel, electro-polished, 4.5 x 4.5 mm
mesh size, heavy gauge



Art-Nr. Part No.	Stiellänge Handle Length	∅ Schaufel ∅ Scoop
86/095	27 cm	10 cm
86/120	27 cm	12 cm
86/160	35 cm	16 cm
86/180	41 cm	18 cm
86/200	43 cm	20 cm
86/260	50 cm	26 cm

Fritterschaufel

rund, aus Edelstahl 18/10, elektroploliert, Gitternetz mit
5 x 5 mm Maschenweite, schwere Qualität

Skimmer/ Spider

round, 18/10 stainless steel, electro-polished, 5 x 5 mm
mesh size, heavy gauge



Art-Nr. Part No.	Stiellänge Handle Length	∅ Schaufel ∅ Scoop
92/280	60 cm	28 cm

Fritterschaufel

rechteckig, aus Edelstahl 18/10, elektroploliert,
Gitternetz mit 4,5 x 4,5 mm Maschenweite,
schwere Qualität

Skimmer

rectangular, 18/10 stainless steel, electro-polished,
4.5 x 4.5 mm mesh size, heavy gauge



Art-Nr. Part No.	Schaufelmaß Scoop dimension cm	Stiellänge Handle Length cm
93/280	28 x 23	61,5

Frittierlöffel

rund, aus Edelstahl, verschweißte Spirale,
Abstand 6 mm

Skimmer/ Spider

round, stainless steel, welded spiral, distance 6 mm



Art-Nr. Part No.	Stiellänge Handle Length	∅ Schaufel ∅ Scoop
95/160	43 cm	15 cm
95/180	43 cm	17,5 cm
95/200	50 cm	20 cm
95/240	50 cm	24 cm
95/255	50 cm	26 cm
95/275	50 cm	28 cm
95/300	50 cm	30 cm

Netzschäumlöffel, feines Gewebe

aus Edelstahl 18/10, matt poliert, feines Gewebe,
Maschenweite 0,6 mm, extrabreiter Rand,
angesetzter Stiel

Skimmer, fine mesh

18/10 stainless steel, matt polished, fine mesh,
mesh size 0.6 mm, extra wide rim, attached handle



Art-Nr. Part No.	Stiellänge Handle Length	∅ Schaufel ∅ Scoop
78/150	40 cm	16 cm

Art-Nr. Part No.	Schaufelmaß Scoop dimension cm	Länge gesamt Total Length cm
973/330	9 x 8,5	33



Woklöffel

Serie POLARIS, seidenmatt polierter Griff, ganz aus Edelstahl 18/10, hochglänzend

Chinese Spatula

with hanging loop, mirror polished with satin polished handle, all 18/10 stainless steel



Art-Nr. Part No.	Schaufelmaß Scoop dimension cm	Länge gesamt Total Length cm
1807/100	41,5 x 28	100



Kessel- /Wurstheber

aus Edelstahl 18/10, 6 mm Perforierung, mit Stiel aus Edelstahlrohr, sehr schwere Ausführung, zum Heben von Gehängen aus Weißwurst, Presssack

Sausages Lifter

18/10 stainless steel, 6 mm perforation, with stainless steel handle, heavy gauge



Art-Nr. Part No.	Stiellänge Handle Length cm	∅ außen ∅ Outside cm	∅ innen ∅ Inside cm
188/090	25,5	9	7,5
188/130	26	13	11,5



Nestbacklöffel

ganz aus Edelstahl, elektropoliert, zweiteilig, 2,5 mm Maschenweite

Birds Nest Fryer

stainless steel, electro-polished, two piece, mesh size 2.5 mm



Art-Nr. Part No.	Schaufelmaß Scoop dimension cm	Stiellänge Handle Length cm
281/200	20 x 17	20



Netzbackschaufel

aus Edelstahl, elektropoliert, Gitter mit 4,4 mm Maschenweite, schwere, robuste Ausführung

Chip Shovel

stainless steel, electro-polished, mesh size 4.4 mm, heavy gauge



Art-Nr. Part No.	Schaufelmaß Scoop dimension cm	Stiellänge Handle Length cm
6083/200	21 x 17	27



Ölfilterschaufel

aus Edelstahl, elektropoliert, feines Gewebe, Maschenweite 1 mm, zum Abschöpfen von groben Schmutzresten aus Ölbädern, insbesondere aus Frittierfett zwischen zwei Frittiervorgängen, schwere, robuste Ausführung

Skimmer

stainless steel, electro-polished, fine mesh, mesh size 1 mm, for removing coarse particles from oil, heavy gauge



Fettschaufel

aus Edelstahl 18/10, mit geschlossenem Hohlgriff, schwere Qualität

Chip Shovel

18/10 stainless steel, closed hollow handle, heavy gauge



Art-Nr. Part No.	Schaufelmaß Scoop dimension cm	Stiellänge Handle Length cm
---------------------	--------------------------------------	-----------------------------------

Gelocht (Ø 8 mm): / Perforated (Ø 8 mm):

280/340 21,5 x 17,5 15,5

Ungelocht: / Plain:

280/820 21,5 x 17,5 15,5

Schaufel

gelocht, aus Edelstahl, hochglänzend, ideal für Pommes frites u.a.

Perforated Chip Scoop

stainless steel, mirror polished



Art-Nr. Part No.	Schaufelmaß Scoop dimension cm	Länge gesamt Total Length cm
---------------------	--------------------------------------	------------------------------------

Mit Flachgriff: / with flat handle:

5698/251 10 x 8 25,5

Mit Hohlgriff: / with hollow handle:

5698/255 10 x 8 25,5

Pommes frites-Schaufel

Serie BUFFET NOIR, mit Griff aus schwarzem Polyamid, Arbeitsteil aus Edelstahl, temperaturbeständig bis +120°C, spülmaschinengeeignet

Chip Scoop

BUFFET NOIR range, stainless steel, with black polyamide handle, heat resistant up to +120°C, dishwasher safe



Art-Nr. Part No.	Schaufelmaß Scoop dimension cm	Länge gesamt Total Length cm
---------------------	--------------------------------------	------------------------------------

8948/280 9 x 10,5 28

Pommes frites-/ Abfüllschaufel

aus Edelstahl 18/10, hochglänzend, auch zum Abfüllen von Gebäck und Konfekt in Tüten, schwere Qualität

Chip Bagger

18/10 stainless steel, mirror polished, heavy gauge



Art-Nr. Part No.	Schaufelmaß Scoop dimension cm	Stiellänge Handle Length cm
---------------------	--------------------------------------	-----------------------------------

Für Rechtshänder: / Right handed:

5610/140 14 x 14 14

5610/170 17 x 17 14

5610/230 23 x 21 14

Für Linkshänder (ohne Abb.): / Left handed (not shown):

5610/231 23 x 21 14

Für Linkshänder (ohne Abb.): / Double handed (not shown):

5610/173 17 x 17 14

5610/233 23 x 21 14

Gyros-/ Dönerschaufel

aus Edelstahl 18/10, mit Kunststoffgriff

Kebab Catcher

18/10 stainless steel, with plastic handle



Art-Nr. Part No.	Schaufelmaß Scoop dimension cm	Höhe Height cm
---------------------	--------------------------------------	----------------------

5688/001 28,5 x 17 9

Pommes frites-Schaufel

ganz aus schwarzem Polyamid, hitzebeständig bis +220°C, lebensmittelgeeignet

Chip Scoop

black polyamide, heat resistant up to +220°C, food safe



Art-Nr. Part No.	Schaufelmaß Scoop dimension cm	Länge Length cm
---------------------	--------------------------------------	-----------------------

3470/120 12 x 14,5 33

Servierlöffel & Gabeln

Mit den Löffeln und Gabeln aus Edelstahl 18/10 haben Sie sowohl in der Küche als auch bei Tisch jene Bestecke, um Speisen zu greifen und ansprechend zu servieren.

Serving Spoons & Forks

18/10 stainless steel spoons and forks, that can be used in the kitchen and to serve attractively at the table.

Art-Nr. Part No.	Löffelmaß Bowl Size cm	Länge gesamt Total Length cm
1850/270	10 x 8	27



Servierlöffel, fugenlos

aus Edelstahl 18/10, hochglänzende Laffe, mit 3 mm starkem seidenmatt poliertem Stiel, flache Form, extra schwere Qualität

Serving Spoon

18/10 stainless steel, mirror polished spoon, with 3 mm thick satin polished handle, shallow design, extra heavy gauge



Art-Nr. Part No.	Löffelmaß Bowl Size cm	Länge gesamt Total Length cm
945/320	10 x 7,5	30,5



Servierlöffel

Serie POLARIS, seidenmatt polierter Griff, ganz aus Edelstahl 18/10, hochglänzende Laffe

Serving Spoon

with hanging loop, mirror polished spoon, with satin polished handle, all 18/10 stainless steel



Art-Nr. Part No.	Löffelmaß Bowl Size cm	Länge gesamt Total Length cm
968/275	9,5 x 6,5	26



Servierlöffel

Serie POLARIS, seidenmatt polierter Griff, Löffel hochglänzend, ganz aus Edelstahl 18/10

Rice spoon

with hanging loop, mirror polished with satin polished handle, all 18/10 stainless steel



Art-Nr. Part No.	Löffelmaß Bowl Size cm	Länge gesamt Total Length cm
902/310	9 x 6,5	31



Servierlöffel, oval

Serie POLARIS, hochglänzende Laffe, mit seidenmatt poliertem Griff, ganz aus Edelstahl 18/10

Serving Spoon

with hanging loop, mirror polished spoon, with satin polished handle, all 18/10 stainless steel



Servierlöffel

Serie ERGONOM, aus Edelstahl 18/0, hochglänzend, ergonomisch profilierter Griff aus Edelstahl 18/0, fugenlos

Serving Spoon

18/10 stainless steel handle, 18/0 stainless steel bowl, mirror polished finish



Art-Nr. Part No.	Löffelmaß Bowl Size cm	Länge gesamt Total Length cm
7780/320	9 x 6,5	32

Servierlöffel, perforiert

Serie ERGONOM, aus Edelstahl 18/0, hochglänzend, ergonomisch profilierter Griff aus Edelstahl 18/0, fugenlos, Lochung Ø 4 mm

Perforated Spoon

18/10 stainless steel handle, 18/0 stainless steel bowl, 4 mm perforations, mirror polished finish



Art-Nr. Part No.	Löffelmaß Bowl Size cm	Länge gesamt Total Length cm
7788/320	9 x 6,5	32

Servierlöffel, flach

aus Edelstahl 18/10, hochglänzend, fugenlos, extra flache Form

Spoon

18/10 stainless steel, mirror polished finish, very shallow bowl



Art-Nr. Part No.	∅ dia.	Länge gesamt Total Length cm
491/285	10 cm	28,5 cm

Servierlöffel

aus Edelstahl 18/10, seidenmatt glänzend, schwere Qualität

Serving Spoon

18/10 stainless steel, satin polished finish, heavy gauge



Art-Nr. Part No.	Löffelmaß Bowl Size cm	Länge gesamt Total Length cm
1017/235	7,5 x 6	22

Servierlöffel

Serie BUFFET ONE, aus Edelstahl 18/10, fugenlos, hochglänzend polierte Laffe, seidenmatt polierter, angewinkelter Stiel

Serving Spoon

18/10 stainless steel, one piece, mirror polished, satin polished angled handle



Art-Nr. Part No.	Löffelmaß Bowl Size cm	Länge gesamt Total Length cm
1846/240	8 x 5	24

Servierlöffel, perforiert

Serie BUFFET ONE, aus Edelstahl 18/10, fugenlos, hochglänzend polierte Laffe, seidenmatt polierter, angewinkelter Stiel

Slotted Spoon

18/10 stainless steel, one piece, mirror polished, satin polished angled handle



Art-Nr. Part No.	Löffelmaß Bowl Size cm	Länge gesamt Total Length cm
1847/245	8 x 5	24



Art-Nr. Part No.	Löffelmaß Bowl Size cm	Länge gesamt Total Length cm
8943/310	7 x 11	31
8943/350	7 x 11	35



Chafing Dish Löffel

Serie BUFFET NOIR, mit Griff aus schwarzem Polyamid, Arbeitsteil aus Edelstahl, temperaturbeständig bis +120°C, spülmaschinengeeignet

Serving Spoon

BUFFET NOIR range, stainless steel, with black polyamide handle, heat resistant up to +120°C, dishwasher safe



Art-Nr. Part No.	Löffelmaß Bowl Size cm	Länge gesamt Total Length cm
943/310	10 x 7,5	31



Servierlöffel, längs perforiert

Serie POLARIS, seidenmatt polierter Griff, ganz aus Edelstahl 18/10, hochglänzend

Slotted Spoon

with hanging loop, mirror polished with satin polished handle, all 18/10 stainless steel



Art-Nr. Part No.	Löffelmaß Bowl Size cm	Länge gesamt Total Length cm
901/310	9 x 6,5	31



Servierlöffel, oval, perforiert

Serie POLARIS, hochglänzend, mit seidenmatt poliertem Griff, ganz aus Edelstahl 18/10

Perforated Spoon

with hanging loop, mirror polished with satin polished handle, all 18/10 stainless steel



Art-Nr. Part No.	Löffelmaß Bowl Size cm	Länge gesamt Total Length cm
1882/350	10 x 7	35



Servierlöffel

aus Edelstahl, fugenlos, hochglänzend, mit Hakengriff, schwere Qualität

Serving Spoon

stainless steel, mirror polished finish, heavy gauge



Art-Nr. Part No.	Löffelmaß Bowl Size cm	Länge gesamt Total Length cm
1883/350	10 x 7	35



Servierlöffel, längs perforiert

aus Edelstahl, fugenlos, hochglänzend, mit Hakengriff, schwere Qualität

Slotted Serving Spoon

stainless steel, mirror polished finish, heavy gauge



Gießlöffel, flache Form

aus Edelstahl 18/0, hochglänzend, fugenlos, mit Haken und Aufhängeöse, schwere Qualität

Serving Spoon

18/0 stainless steel, mirror polished finish, one piece, heavy gauge

18/0
EDELSTAHL
STAINLESS STEEL



Art-Nr. Part No.	Löffelmaß Bowl Size cm	Stiellänge Handle Length cm	
5606/305	10 x 7	20	0,05 l
5606/355	10 x 7	25	0,05 l
5606/405	10 x 7	30	0,05 l

Gemüselöffel, perforiert

aus Edelstahl 18/0, hochglänzend, fugenlos, flache Form, 5 mm-Lochung, mit Haken und Aufhängeöse, schwere Qualität

Perforated Spoon

18/0 stainless steel, one piece, mirror polished finish, 5 mm perforations, heavy gauge

18/0
EDELSTAHL
STAINLESS STEEL



Art-Nr. Part No.	Löffelmaß Bowl Size cm	Stiellänge Handle Length cm	
5608/305	10 x 7	20	
5608/355	10 x 7	25	
5608/405	10 x 7	30	

Saucengießlöffel

fugenlos, aus Edelstahl 18/10, hochglänzend, schwere Qualität

Sauce/Gravy Ladle

one piece, 18/10 stainless steel, mirror polished finish, heavy gauge

18/10
EDELSTAHL
STAINLESS STEEL



Art-Nr. Part No.	Löffelmaß Bowl Size cm	Stiellänge Handle Length cm	
715/175	7 x 5	14	0,015 l

Saucengießlöffel

aus Edelstahl 18/0, hochglänzend poliert, schwere Qualität

Sauce Ladle

18/0 stainless steel, mirror polished finish

18/0
EDELSTAHL
STAINLESS STEEL



Art-Nr. Part No.	Löffelmaß Bowl Size cm	Stiellänge Handle Length cm	
1016/170	6 x 6	14	0,025 l

Portionsvorleger

Serie BUFFET ONE, aus Edelstahl 18/10, fugenlos, hochglänzend polierte Laffe, seidenmatt polierter, angewinkelter Stiel

Serving Ladle

BUFFET ONE range, 18/10 stainless steel, one piece, mirror polished, satin polished angled handle

18/10
EDELSTAHL
STAINLESS STEEL



Art-Nr. Part No.	∅ cm dia. cm	Stiellänge Handle Length cm	
3351/255	6,5	20	0,05 l



Art-Nr. Part No.		Ø dia. cm	Stiellänge Handle Length cm
5362/060	30 ml	5	23



Dressinglöffel
aus glasklarem Polycarbonat

Ladle
clear polycarbonate



Art-Nr. Part No.	Löffelmaß Bowl Size cm	Länge Length cm	Farbe Colour
4902/231	7 x 6	23,5	schwarz/black
4902/235	7 x 6	23,5	weiß/white



Salatlöffel
aus SAN-Kunststoff,
Serving Spoon
SAN plastic



perforiert: / perforated:			
4904/235	9,5 x 6	23,5	schwarz/black

Art-Nr. Part No.	Löffelmaß Bowl Size cm	Länge Length cm
4903/335	10 x 7	33,5



Salatlöffel
aus weißem SAN-Kunststoff, gerader langer Stiel
Serving Spoon
white SAN plastic, long straight handle



Art-Nr. Part No.	Löffelmaß Bowl Size cm	Länge gesamt Total Length cm
3474/300	8,5 x 7	30



Servierlöffel, tief
ganz aus schwarzem Polyamid, hitzebeständig bis
+220°C, lebensmittelgeeignet

Serving Spoon
black polyamide, heat resistant up to +220°C, food safe



Art-Nr. Part No.	Löffelmaß Bowl Size cm	Länge gesamt Total Length cm
3471/285	8 x 6	28,5



Servierlöffel Polyamid
ganz aus schwarzem Polyamid, hitzebeständig bis
+220°C, lebensmittelgeeignet

Serving Spoon
black polyamide, heat resistant up to +220°C, food safe



Art-Nr. Part No.	Zinkenlänge Prongs Length cm	Länge gesamt Total Length cm
3476/285	6	28,5



Serviergabel, Polyamid
ganz aus schwarzem Polyamid, hitzebeständig bis
+220°C, lebensmittelgeeignet

Serving Fork
black polyamide, heat resistant up to +220°C, food safe



Salatlöffel

Serie BUFFET ONE, aus Edelstahl 18/10, fugenlos, hochglänzend polierte Laffe, seidenmatt polierter, angewinkelter Stiel

Salad Spoon

BUFFET ONE range, 18/10 stainless steel, one piece, mirror polished, satin polished angled handle

18/10
EDELSTAHL
STAINLESS STEEL



Art-Nr. Part No.	Löffelmaß Bowl Size cm	Länge gesamt Total Length cm
3356/305	8,5 x 6	30,5

Salatgabel

Serie BUFFET ONE, aus Edelstahl 18/10, fugenlos, hochglänzend polierte Laffe, seidenmatt polierter, angewinkelter Stiel

Salad Fork

BUFFET ONE range, 18/10 stainless steel, one piece, mirror polished, satin polished angled handle

18/10
EDELSTAHL
STAINLESS STEEL



Art-Nr. Part No.	Löffelmaß Bowl Size cm	Länge gesamt Total Length cm
3355/305	8,5 x 6	30,5

Salatlöffel, klein

Serie BUFFET ONE, aus Edelstahl 18/10, fugenlos, hochglänzend polierte Laffe, seidenmatt polierter, angewinkelter Stiel

Small Salad Spoon

BUFFET ONE range, 18/10 stainless steel, one piece, mirror polished, satin polished angled handle

18/10
EDELSTAHL
STAINLESS STEEL



Art-Nr. Part No.	Löffelmaß Bowl Size cm	Länge gesamt Total Length cm
3363/235	5,5 x 4,5	23,5

Salatgabel, klein

Serie BUFFET ONE, aus Edelstahl 18/10, fugenlos, hochglänzend polierte Laffe, seidenmatt polierter, angewinkelter Stiel

Small Salad Fork

BUFFET ONE range, 18/10 stainless steel, one piece, mirror polished, satin polished angled handle

18/10
EDELSTAHL
STAINLESS STEEL



Art-Nr. Part No.	Löffelmaß Size cm	Länge gesamt Total Length cm
3364/235	5,5 x 4,5	23,5

Salatlöffel

aus Edelstahl 18/10, hochglänzend, mit seidenmatt poliertem Stiel

Salad Spoon

18/10 stainless steel, mirror polished, with satin polished handle

18/10
EDELSTAHL
STAINLESS STEEL



Art-Nr. Part No.	Löffelmaß Bowl Size cm	Länge gesamt Total Length cm
730/290	9 x 7,5	29,5

Salatgabel

aus Edelstahl 18/10, hochglänzend, mit seidenmatt poliertem Stiel

Salad Fork

18/10 stainless steel, mirror polished, with satin polished handle

18/10
EDELSTAHL
STAINLESS STEEL



Art-Nr. Part No.	Zinkenlänge Prongs Length cm	Länge gesamt Total Length cm
731/290	7 cm	29,5 cm



Art-Nr. Part No.	Löffelmaß Bowl Size cm	Länge gesamt Total Length cm
971/300	8,5 x 7	30



Salat-/ Risottolöffel

Serie POLARIS, seidenmatt polierter Griff, ganz aus Edelstahl 18/10, hochglänzend

Salad Spoon

with hanging loop, mirror polished with, satin polished handle, all 18/10 stainless steel



Art-Nr. Part No.	Löffelmaß Bowl Size cm	Länge gesamt Total Length cm
972/300	8,5 x 7	30



Salatgabel

Serie POLARIS, seidenmatt polierter Griff, ganz aus Edelstahl 18/10, hochglänzend

Salad Fork

with hanging loop, mirror polished with, satin polished handle, all 18/10 stainless steel



Art-Nr. Part No.	Löffelmaß Bowl Size cm	Länge gesamt Total Length cm
7787/300	8 x 6,5	30



Salatlöffel

Serie ERGONOM, aus Edelstahl 18/0, hochglänzend, ergonomisch profilierter Griff aus Edelstahl 18/10, fugenlos

Salad Spoon

18/10 stainless steel handle, 18/0 stainless steel bowl, mirror polished finish



Art-Nr. Part No.	Löffelmaß Bowl Size cm	Länge gesamt Total Length cm
7786/300	8 x 6,5	30



Salatgabel

Serie ERGONOM, aus Edelstahl 18/0, hochglänzend, ergonomisch profilierter Griff aus Edelstahl 18/10, fugenlos

Salad Fork

18/10 stainless steel handle, 18/0 stainless steel bowl, mirror polished finish



Art-Nr. Part No.	Löffelmaß Bowl Size cm	Länge gesamt Total Length cm
1999/022	4,5 x 6	19,5



Salatlöffel

Serie LOUISA, aus Edelstahl 18/10, hochglänzend poliert

Salad Spoon

18/10 stainless steel, mirror polished finish



Art-Nr. Part No.	Löffelmaß Size cm	Länge gesamt Total Length cm
1999/023	4,5 x 6	19,5



Salatgabel

Serie LOUISA, aus Edelstahl 18/10, hochglänzend poliert

Salad Fork

18/10 stainless steel, mirror polished finish



Art-Nr. Part No.	Löffelmaß Bowl Size cm	Länge gesamt Total Length cm
7777/002	7 x 7	29



Salatbesteck

zweiteilig, aus Edelstahl 18/10, hochglänzend, schwere Qualität

Salad Serving Set

18/10 stainless steel, mirror polished finish, heavy gauge



Pellkartoffelgabel

Serie POLARIS, mit seidenmatt poliertem Griff aus
Edelstahl 18/10, mit drei Drahtzinken aus
Edelstahl 18/10, Drahtdicke 1,4 mm, hochglänzend



Potato Fork

all 18/10 stainless steel, three prongs Ø 1.4 mm



Art-Nr. Part No.	Zinkenlänge Prongs Length cm	Länge gesamt Total Length cm
906/165	2,5	16,5

Schneckengabel

aus Edelstahl 18/0, hochglänzend

Snail Fork

18/0 stainless steel, mirror polished finish



Art-Nr. Part No.	Zinkenlänge Prongs Length cm	Länge gesamt Total Length cm
32/150	3 cm	14 cm

Aufschnitt-/ Schneckengabel

aus Edelstahl 18/10, seidenmatt

Serving / Snail Fork

18/10 stainless steel, satin polished finish



Art-Nr. Part No.	Zinkenlänge Prongs Length cm	Länge gesamt Total Length cm
30/155	4,5 cm	15,5 cm

Aufschnittgabel

aus Edelstahl 18/0, hochglänzend

Serving Fork

18/0 stainless steel, mirror polished finish



Art-Nr. Part No.	Zinkenlänge Prongs Length cm	Länge gesamt Total Length cm
404/030	4,5	19

Aufschnittgabel

aus Edelstahl 18/10, hochglänzend

Serving Fork

18/10 stainless steel, mirror polished finish



Art-Nr. Part No.	Zinkenlänge Prongs Length cm	Länge gesamt Total Length cm
1999/030	4,5	16,0

Aufschnittgabel

aus Edelstahl 18/0, hochglänzend

Serving Fork

18/0 stainless steel, mirror polished finish



Art-Nr. Part No.	Zinkenlänge Prongs Length cm	Länge gesamt Total Length cm
1019/195	4,5	19,5

Aufschnittgabel

aus Edelstahl 18/10, seidenmatt glänzend,
schwere Qualität

Serving Fork

18/10 stainless steel, satin polished finish, heavy gauge



Art-Nr. Part No.	Zinkenlänge Prongs Length cm	Länge gesamt Total Length cm
1018/240	6 cm	24 cm



Art-Nr. Part No.	Zinkenlänge Prongs Length	Länge gesamt Total Length
3670/240	10 cm	24 cm

Preis und Verpackung à 3 St.; farblich sortiert.
Priced and packed in 3's.



Aufschnittgabel-Set

aus Edelstahl 18/0, matt poliert mit geraden Zinken, mit ABS-Griff (weiß, schwarz, rot), leichte stabile Qualität

Meat Forks (set of 3)

18/0 stainless steel, matt polished finish, with straight prongs, ABS handles (white, black, red)



Art-Nr. Part No.	Zinkenlänge Prongs Length	Zoll	Länge gesamt Total Length
6039/170	10 cm	4"	27,5 cm



Fleischgabel

aus Chrom-Molybdän-Vanadium (x50CrMoV15), Griff aus Polypropylen, spülmaschinengeeignet

Fork

chrome-molybdenum-vanadium (x50CrMoV15) blade, black polypropylene handle, dishwasher safe



Art-Nr. Part No.	Zinkenlänge Prongs Length	Länge gesamt Total Length
169/400	12,5 cm	40 cm
169/500	12,5 cm	50 cm



Fleischgabel

aus Edelstahl 18/10, seidenmatt poliert, fugenlos, Griff mit Haken, schwere Qualität

Meat Fork

18/10 stainless steel, matt polished finish, one piece, with hook, heavy gauge



Art-Nr. Part No.	Zinkenlänge Prongs Length	Länge gesamt Total Length
1885/350	6,5 cm	35 cm



Fleischgabel

aus Edelstahl, fugenlos, hochglänzend, mit Hakengriff, schwere Qualität

Meat Fork

stainless steel, one piece, mirror polished finish, heavy gauge



Art-Nr. Part No.	Zinkenlänge Prongs Length	Länge gesamt Total Length
985/330	9 cm	30 cm



Fleischgabel

Serie POLARIS, mit seidenmatt poliertem Griff, ganz aus Edelstahl 18/10, hochglänzend

Fork

satin polished handle, with hanging loop, all 18/10 stainless steel, mirror polished



Art-Nr. Part No.	Zinkenlänge Prongs Length	Zoll	Länge gesamt Total Length
3605/150	9 cm	6"	28 cm
3605/200	9 cm	8"	32 cm



Fleischgabel

mit gebogenen Zinken aus geschmiedetem Chrom-Molybdän-Vanadium (DIN x50CrMoV15), vernietet und verschweißter Griff aus POM-Kunststoff, spülmaschinengeeignet, schwere Profiqualität, ideal auch zum Wenden von Bratgut in der Pfanne.

Fork

high grade molybdenum vanadium stainless steel, one piece drop forged, bolster and tang, with black POM handle, professional quality, with curved prongs



Tranchiergabel

mit geraden Zinken aus geschmiedetem Chrom-Molybdän-Vanadium (DIN x50CrMoV15), vernieteter und verschweißter Griff aus POM-Kunststoff, spülmaschinengeeignet, schwere Profiqualität

Fork

high grade molybdenum vanadium stainless steel, one piece drop forged, bolster and tang, with black POM handle, professional quality, with straight prongs



Art-Nr. Part No.	Zinkenlänge Prongs Length cm	Zoll	Länge gesamt Total Length cm
3604/150	12	5"	28
3604/170	14,5	6"	30,5

Tranchiergabel

geschmiedete gerade Zinken aus Messer Stahl X30Cr13, vernieteter und verschweißter Griff aus schwarzem Melamin, mit Edelstahlnieten, spülmaschinenegeeignet, schwere Qualität, mit geraden Zinken

Fork

high grade molybdenum vanadium stainless steel, one piece drop forged prongs 56 HRC (Rockwell), bolster and tang, with black POM handle, professional quality



Art-Nr. Part No.	Zinkenlänge Prongs Length cm	Zoll	Länge gesamt Total Length cm
4604/150	17	6"	28,5

Tranchiergabel

Serie POLARIS, mit seidenmatt poliertem Griff aus Edelstahl 18/10, Zinken aus hochglänzendem Edelstahl 18/0

Carving Fork

handle 18/10 stainless steel, with hanging loop, 18/0 stainless steel prongs, mirror polished



Art-Nr. Part No.	Zinkenlänge Prongs Length cm	Länge gesamt Total Length cm
984/310	8	32

Tranchiergabel

Serie ERGONOM, aus Edelstahl 18/0, hochglänzend, ergonomisch profilierter Griff aus Edelstahl 18/10, fugenlos

Fork

18/10 stainless steel handle, 18/0 stainless steel prongs, mirror polished finish



Art-Nr. Part No.	Zinkenlänge Prongs Length cm	Länge gesamt Total Length cm
7781/320	8 cm	32 cm

Tranchiergabel

Serie BUFFET ONE, aus Edelstahl 18/10, fugenlos, hochglänzend polierte Forken, seidenmatt polierter, angewinkelter Stiel

Carving Fork

BUFFET ONE range, 18/10 stainless steel, one piece, mirror polished prongs, satin polished angled handle



Art-Nr. Part No.	Zinkenlänge Prongs Length cm	Länge gesamt Total Length cm
3367/290	13	28,5



Art-Nr. Part No.	Zinkenlänge Prongs Length cm	Länge gesamt Total Length cm
3360/340	9,5	34



Bratengabel

Serie BUFFET ONE, aus Edelstahl 18/10, fugenlos, hochglänzend polierte Zinken, seidenmatt polierter, angewinkelter Stiel

Meat Fork

BUFFET ONE range, 18/10 stainless steel, one piece, mirror polished, satin polished angled handle



Art-Nr. Part No.	Zinkenlänge Prongs Length cm	Länge gesamt Total Length cm
5662/440	9 cm	44 cm



Grillgabel

aus 1,5 mm starkem Edelstahl 18/10, hochglänzend, mit seidenmattem ovalen Rohrgriff, hochwertige Qualität

Barbecue Fork

1.5 mm thick 18/10 stainless steel, mirror polished, with satin polished oval handle, heavy gauge



Art-Nr. Part No.	Zinkenlänge Prongs Length cm	Länge gesamt Total Length cm
3336/400	9,5 cm	40 cm
3336/500	9,5 cm	50 cm
3336/600	9,5 cm	60 cm



Kessel- /Fleischgabel

geschmiedet aus Chrom-Molybdän-Vanadium-Stahl, mit Hakengriff aus Edelstahl 18/10, schwere Qualität

Large Fork

molybdenum vanadium stainless steel, forged, with hooked handle made of 18/10 stainless steel, heavy gauge



Art-Nr. Part No.	Zinkenlänge Prongs Length cm	Länge gesamt Total Length cm
3337/450	9,5 cm	45 cm
3337/500	9,5 cm	50 cm
3337/600	9,5 cm	60 cm



Kesselgabel

geschmiedet aus Chrom-Molybdän-Vanadium-Stahl, mit Kunststoff-Griff, schwere Qualität

Large Fork

molybdenum vanadium stainless steel, forged, with plastic handle, heavy gauge



Art-Nr. Part No.	Länge außen Outer Length cm	Breite Width cm
155/420	42 cm	1,5 cm



Hängeleiste

aus 2,5 mm starkem Edelstahl 18/10, hochglänzend, zur Wandmontage mit zwei Schraubenlöchern, schwere Qualität

Hanging Rack

2.5 mm thick 18/10 stainless steel, mirror polished finish, for wall mounting, heavy gauge



Wender & Zangen

Perfektes Besteck zum Auflegen, Wenden, Greifen und Servieren. Für wirklich jeden Handgriff und jede Zubereitungsart gibt es von **contacto** praktische Küchenhelfer in bester Qualität

Slices & Tongs

Ideal utensils for turning, gripping and serving.

contacto has top quality practical tools for every kitchen requirement.



Pfannenschaufel

aus Edelstahl 18/10, hochglänzend, fugenlos, extra schwere Qualität

Slice

18/10 stainless steel, mirror polished finish, one piece, extra heavy gauge



Art-Nr. Part No.	Schaufelmaß Scoop dimension cm	Stiellänge Handle Length cm
162/280	11 x 11	28
162/360	11 x 11	36

Pfannenschaufel

mit perforiertem Blatt, aus Edelstahl 18/10, hochglänzend, fugenlos, 4 mm Lochung, schwere Qualität

Perforated Slice

18/10 stainless steel, mirror polished finish, with 4 mm perforations, heavy gauge



Art-Nr. Part No.	Schaufelmaß Scoop dimension cm	Stiellänge Handle Length cm
166/110	11 x 11	26
167/110	11 x 11	36

Fischbackschaufel

mit perforiertem Blatt, aus Edelstahl 18/10, hochglänzend, fugenlos, schwere Qualität

Slotted Slice

18/10 stainless steel, mirror polished finish, one piece, heavy gauge



Art-Nr. Part No.	Schaufelmaß Scoop dimension cm	Stiellänge Handle Length cm
147/110	11 x 11	36

Pfannenschaufel

mit perforiertem Blatt, aus Edelstahl 18/10, hochglänzend, fugenlos, 3,5 mm Lochung

Perforated Slice

18/10 stainless steel, mirror polished finish, one piece with 3.5 mm perforations



Art-Nr. Part No.	Schaufelmaß Scoop dimension cm	Stiellänge Handle Length cm
160/090	9 x 7,5	25
160/100	9,5 x 10	36,5
160/120	10,5 x 12	39,5



Art-Nr. Part No.	Schaufelmaß Scoop dimension cm	Stiellänge Handle Length cm
163/280	18 x 14	28
163/500	18 x 14	50



Kippbratpfannenschaufel

aus Edelstahl 18/10, hochglänzend, fugenlos, schwere Qualität

Slice

18/10 stainless steel, mirror polished finish, one piece, heavy gauge



Art-Nr. Part No.	Schaufelmaß Scoop dimension cm	Stiellänge Handle Length cm
143/180	18 x 14	28



Kippbratpfannenschaufel

mit perforiertem Blatt, aus Edelstahl 18/10, hochglänzend, fugenlos, extra große Schauffelfläche, 4 mm Lochung, schwere Qualität

Perforated Slice

18/10 stainless steel, mirror polished finish, one piece, with 4 mm perforations, extra large blade, heavy gauge



Art-Nr. Part No.	Spatelmaß Blade cm	Stiellänge Handle Length cm
165/050	13 x 13	35,5
165/100	13 x 13	85



Reduier spatel

mit perforiertem Blatt, aus Edelstahl 18/10, hochglänzend, 5 mm Lochung, ungekröpfter Spatel, schwere Qualität

Reducing Spatula

18/10 stainless steel, mirror polished finish, with 5 mm perforations, heavy gauge



Art-Nr. Part No.	Spatelmaß Blade cm	Länge gesamt Total Length cm
5690/300	17 x 5	42



Pfannen-/Paella- Schieber

aus Edelstahl 18/10, hochglänzend, fugenlos, mit Hakenstiel, zum Wenden von Speisen in Riesenpfannen, z.B. Pilz- oder Paella-Gerichten

Paella Slice

18/10 stainless steel, mirror polished, one piece



Art-Nr. Part No.	Schaufelmaß Scoop dimension cm	Länge gesamt Total Length cm
5699/470	12 x 12,5	48



Paella-/Pilz-Schaufel

aus Edelstahl 18/10, hochglänzend, fugenlos, mit Hakenstiel, zum Servieren von Speisen aus Riesenpfannen, z.B. Pilz- oder Paella-Gerichten

Paella Scoop

18/10 stainless steel, mirror polished, one piece



Fischheber

mit perforiertem Blatt, aus Edelstahl 18/10, hochglänzend, fugenlos, 3,5 mm Lochung, schwere Qualität

Fish Slice

18/10 stainless steel, with perforated blade, mirror polished finish, one piece, with 3.5 mm perforations, heavy gauge

18/10
EDELSTAHL
STAINLESS STEEL



Art-Nr. Part No.	Schaufelmaß Scoop dimension cm	Stiellänge Handle Length cm
168/330	12 x 16	31

Grillwender

aus 1,5 mm starkem Edelstahl 18/10, hochglänzend, mit seidenmattem ovalen Rohrgriff, geschlitzte Fläche beidseitig gezahnt und vorne verjüngt, hochwertige Qualität

Barbecue slice

1.5 mm thick 18/10 stainless steel, mirror polished, with satin polished oval handle, serrated, slotted blade, heavy gauge

18/10
EDELSTAHL
STAINLESS STEEL



Art-Nr. Part No.	Spatelmaß Blade cm	Länge gesamt Total Length cm
5661/450	11 x 9	45 cm

Bratenwender, längs perforiert

aus Edelstahl, fugenlos, hochglänzend, mit Hakengriff

Slotted Slice

stainless steel, one piece, mirror polished finish

INOX
EDELSTAHL
STAINLESS STEEL



Art-Nr. Part No.	Spatelmaß Blade cm	Länge gesamt Total Length cm
1886/380	10 x 7,5	38

Mehrzweckwender

aus Edelstahl 18/10, hochglänzend, fugenlos, schwere Qualität

Slotted Slice

18/10 stainless steel, mirror polished finish, one piece, heavy gauge

18/10
EDELSTAHL
STAINLESS STEEL



Art-Nr. Part No.	Spatelmaß Blade cm	Länge gesamt Total Length cm
5604/275	11 x 7,5	38

Pfannenschaufel

aus Edelstahl 18/10, hochglänzend, fugenlos, mit kurzem Stiel, perforiertes Blatt mit 3,5 mm Lochung

Perforated Slice

18/10 stainless steel, mirror polished finish, one piece, short handle, with 3.5 mm perforations

18/10
EDELSTAHL
STAINLESS STEEL



Art-Nr. Part No.	Spatelmaß Blade cm	Stiellänge Handle Length cm
5605/280	9,5 x 8	20

Pfannenschaufel

Serie ERGONOM, aus Edelstahl 18/0, hochglänzend, ergonomisch profilierter Griff, fugenlos, schwere Qualität

Slotted Slice

18/0 stainless steel, mirror polished finish, ergonomically designed handle, one piece

18/0
EDELSTAHL
STAINLESS STEEL



Art-Nr. Part No.	Spatelmaß Blade cm	Länge gesamt Total Length cm
7795/360	10,5 x 8	36



Art-Nr. Part No.	Schaufelmaß Scoop dimension cm	Länge gesamt Total Length cm
5692/355	15 x 7	34,5



Fischwender

aus Edelstahl 18/0, hochglänzend, fugenlos, mit Aufhängeöse, 5 mm Lochung

Perforated Fish Lifter

18/0 stainless steel, mirror polished finish, one piece, with hanging loop, 5 mm perforations



Art-Nr. Part No.	Spatelmaß Blade cm	Länge gesamt Total Length cm
904/090	9 x 7	34



Pfannenwender

Serie POLARIS, ganz aus Edelstahl 18/10, mit seidenmatt poliertem Griff, mit kurzem sehr stark angewinkeltem Blatt

Slice / Lifter

with satin polished handle all 18/10 stainless steel



Art-Nr. Part No.	Spatelmaß Blade cm	Länge gesamt Total Length cm
909/130	13 x 7	38



Pfannenwender

Serie POLARIS, ganz aus Edelstahl 18/10, mit langem sehr stark angewinkeltem Blatt

Perforated Slice / Lifter

handle satin polished, all 18/10 stainless steel



Art-Nr. Part No.	Spatelmaß Blade cm	Länge gesamt Total Length cm
975/320	13 x 8	29



Pfannenwender

Serie POLARIS, mit seidenmatt poliertem Griff aus Edelstahl 18/10, Spatel aus hochglänzendem Edelstahl 18/0, leicht angewinkeltes Blatt

Slotted Slice

handle 18/10 stainless steel, with hanging loop, blade 18/0 stainless steel



Art-Nr. Part No.	Spatelmaß Blade cm	Länge gesamt Total Length cm
977/330	8,5 x 8	33



Pfannenwender

Serie POLARIS, mit seidenmatt poliertem Griff aus Edelstahl 18/10, Spatel aus hochglänzendem Edelstahl 18/0, angewinkeltes Blatt

Slotted Slice

handle 18/10 stainless steel, with hanging loop, blade 18/0 stainless steel



Art-Nr. Part No.	Spatelmaß Blade cm	Länge gesamt Total Length cm
936/250	13,5 x 7	25



Pfannenwender

Serie POLARIS, mit seidenmatt poliertem Griff aus Edelstahl 18/10, Spatel aus Edelstahl 18/0, hochglänzend, vorderer Blattbereich angewinkelt, schwere Qualität

Egg Lifter

with hanging loop, handle 18/10 stainless steel, blade 18/0 stainless steel



Pfannenwender

aus Edelstahl 18/0, hochglänzend,
mit Griff aus schwarzem Polypropylen,
flexibles längsperforiertes Blatt

Slotted Egg Lifter

18/0 stainless steel, mirror polished finish,
with black polypropylene handle, flexible blade



Art-Nr. Part No.	Spatelmaß Blade cm	Länge gesamt Total Length cm
4056/175	17,5 x 8	31

Pfannenwender

aus grauem glasfaserverstärktem Polyamid,
gut geeignet für antihaf-beschichtete Pfannen,
hitzeresistent bis +220°C

Slotted Turner

grey polyamide, for non-stick pans, heat resistant
up to + 220 °C



Art-Nr. Part No.	Spatelmaß Blade cm	Länge gesamt Total Length cm
1973/300	16 x 9	30

Pfannenwender

Serie POLARIS, aus schwarzem Polyamid mit Griff aus
Edelstahl 18/10, spülmaschineneeignet,
hitzebeständig bis +220°C, gut geeignet für antihaf-
beschichtete Pfannen

Slotted Egg Lifter

with hanging loop, handle 18/10 stainless steel,
dishwasher proof, black polyamide blade, especially for
use on non-stick pans, heat resistant up to +220°C



Art-Nr. Part No.	Spatelmaß Blade cm	Länge gesamt Total Length cm
966/320	17 x 8	32

Pfannenwender

aus glasfaserverstärktem Polyamid, gut geeignet für
antihaf-beschichtete Pfannen, hitzeresistent bis +220°C

Cranked Turner

polyamide, for non-stick pans,
heat resistant up to + 220 °C



Art-Nr. Part No.	Spatelmaß Blade cm	Länge gesamt Total Length cm
1972/320	12 x 9	32

Wender, flexibel

aus flexiblem 0,8 mm starkem Edelstahl, seidenmatt
poliert, vernietet und verschweißter Griff aus POM-
Kunststoff, schwere Profi-Qualität

Spatula

flexible 0.8 mm thick stainless steel,
satin polished finish, riveted POM handle,
heavy gauge, made in Solingen, Germany



Art-Nr. Part No.	Spatelmaß Blade cm	Länge gesamt Total Length cm
3726/200	20 x 7,5	37



Art-Nr. Part No.	Spatelmaß Blade cm	Länge gesamt Total Length cm
4058/115	14 x 5	31



Wender, flexibel

aus Edelstahl 18/0, matt poliert, mit Griff aus schwarzem Polypropylen, stark angewinkeltes Blatt

Cranked Turner

18/0 stainless steel blade, matt polished finish, with polypropylene handle



Art-Nr. Part No.	Spatelmaß Blade cm	Länge gesamt Total Length cm
2252/065	10 x 6,5	26
2252/090	12 x 9	28
2252/100	12,5 x 10	30



Wender, flexibel

aus flexiblem Edelstahl 18/0, mit schwarzem glasfaser-verstärkten Polyamid-Griff

Cranked Turner

18/0 tempered stainless steel, flexible blade, black fibreglass reinforced polyamide handle,



Art-Nr. Part No.	Spatelmaß Blade cm	Länge gesamt Total Length cm
4062/350	20 x 7,5	40



Bratenwender

perforiert, aus starrem Edelstahl 18/0, seidenmatt poliert, mit Griff aus weißem Polypropylen, 7 mm Lochung, stark angewinkeltes Blatt

Cranked Turner

stainless steel blade, perforated and rigid, satin polished finish, with white polypropylene handle, 7 mm perforations



Art-Nr. Part No.	Spatelmaß Blade cm	Länge gesamt Total Length cm
4064/350	20 x 7,5	40



Bratenwender

aus starrem Edelstahl 18/0, seidenmatt poliert, mit Griff aus schwarzem Polypropylen, stark angewinkeltes Blatt, schwere Qualität

Cranked Turner

rigid 18/0 stainless steel blade, satin polished finish, with black polypropylene handle



Art-Nr. Part No.	Spatelmaß Blade cm	Länge gesamt Total Length cm
8945/350	7,5 x 9,5	35



Pfannenwender

Serie BUFFET NOIR, mit Griff aus schwarzem Polyamid, Arbeitsteil aus Edelstahl, temperaturbeständig bis +120°C, spülmaschinengeeignet

Slice

BUFFET NOIR range, stainless steel, with black polyamide handle, heat resistant up to +120°C, dishwasher safe



Art-Nr. Part No.	Spatelmaß Blade cm	Länge gesamt Total Length cm
4170/115	14 x 9,5	30,5



Bratenwender

aus Edelstahl 18/0, hochglänzend, starres Blatt, mit Griff aus schwarzem Polypropylen

Cranked Turner

18/0 stainless steel, rigid, slotted, mirror polished, with black polypropylene handle



Pizzaheber, groß

aus Edelstahl 18/0, matt poliert, linke und vordere Kante schräg angeschliffen, mit schwarzem Griff aus Polypropylen, schwere Qualität

Pizza Slice

18/0 stainless steel blade, matt polished finish, sharp left and front edge, with black polypropylene handle, heavy gauge



Art-Nr. Part No.	Spatelmaß Blade cm	Länge gesamt Total Length cm
4069/190	19 x 15	32

Bratenwender

aus Edelstahl 18/0, hochglänzend, starres Blatt, vorne angeschliffen, mit Griff aus schwarzem Polypropylen

Cranked Turner

rigid, 18/0 stainless steel blade, sharpened front, mirror polished, with black polypropylene handle



Art-Nr. Part No.	Spatelmaß Blade cm	Länge gesamt Total Length cm
4167/160	14 x 9,5	30,5

Bratenspachtel /-wender

aus starrem Edelstahl, matt, mit Griff aus schwarzem Polypropylen

Pizza Server

stainless steel, with black polypropylene handle



Art-Nr. Part No.	Spatelmaß Blade cm	Länge gesamt Total Length cm
4065/280	11,5 x 9	27,5

Bratenspachtel / Fettabstecher

aus Edelstahl, starkes starres Blatt, an allen Kanten angeschliffen, mit Holzgriff, schwere Qualität

Cranked Turner

stainless steel, very rigid, sharpened edges, wooden handle



Art-Nr. Part No.	Spatelmaß Blade cm	Länge gesamt Total Length cm
4173/135	13,5 x 11	30

Bratenspachtel/ Fettabstecher

aus starrem Edelstahl, hochglänzend, stark angewinkeltes Blatt an Kanten schräg angeschliffen, mit Griff aus schwarzem Polypropylen

Turner/Scraper

rigid stainless steel blade, mirror polished finish, with black polypropylene handle



Art-Nr. Part No.	Spatelmaß Blade cm	Länge gesamt Total Length cm
4066/300	12 x 7	30

Bratenspachtel

aus starrem Edelstahl 18/0, hochglänzend, mit Griff aus weißem Polypropylen, mit geschärfter Vorderkante

Griddle Scraper

rigid 18/0 stainless steel blade, mirror polished finish, with white polypropylene handle, sharpened leading edge



Art-Nr. Part No.	Spatelmaß Blade cm	Länge gesamt Total Length cm
4060/080	12 x 8	25
4060/100	11,5 x 10	25



Art-Nr. Part No.	Spatelmaß Blade cm	Länge gesamt Total Length cm
2250/060	12 x 6	24
2250/080	12 x 8	24
2250/100	12 x 10	24



Bratenspachtel

mit starrem Blatt aus gehärtetem Edelstahl 18/0, mit schwarzem glasfaserverstärktem Polyamid-Griff, vielseitiges Utensil zum Reinigen, Abstechen, Glätten, Wenden usw.

Griddle Scraper

18/0 stainless steel tempered blade, black fibreglass reinforced polyamide handle, heavy gauge



Art-Nr. Part No.	Spatelmaß Blade cm	Länge gesamt Total Length cm
3030/100	11,5 x 10	21,5



Bratenspachtel

aus starrem Edelstahl 18/0, hochglänzend, Holzgriff lackiert

Griddle Scraper

rigid stainless steel blade, mirror polished finish, lacquered wooden handle



Art-Nr. Part No.	Spatelmaß Blade cm	Länge gesamt Total Length cm
2254/240	9 x 6,5	24



Pfannenspachtel

starres Blatt aus gehärtetem Edelstahl 18/0, mit schwarzem glasfaserverstärktem Polyamid-Griff, zur vielseitigen Anwendung

Short Spatula

rigid 18/0 stainless steel tempered blade, black fibreglass reinforced polyamide handle, heavy gauge



Art-Nr. Part No.	Breite Width cm	Länge gesamt Total Length cm
3477/300	5	30
3477/375	7,5	37,5



Pfannenspatel, Polyamid

ganz aus schwarzem Polyamid, hitzebeständig bis +220°C, lebensmittelgeeignet, spülmaschinene geeignet, geeignet zum Reinigen von Antihaft-Oberflächen

Griddle Scraper

black polyamide, heat resistant up to +220°C, food safe, dishwasher safe, ideal for cleaning non-stick surfaces



Art-Nr. Part No.	Spatelmaß Blade cm	Länge gesamt Total Length cm	Stärke Thickness cm
836/030	12 x 6	30	0,5



Pfannenwender

aus unbehandeltem naturbelassenem Buchenholz, mit verjüngter Vorderkante

Wooden Spatula

unlacquered smooth beechwood, not dishwasher proof



Art-Nr. Part No.	Spatelmaß Blade cm	Länge gesamt Total Length cm
831/130	5 x 4	13



Raclettespachtel

aus unbehandeltem naturbelassenem Buchenholz, abgeflachte Vorderkante, nicht spülmaschinene geeignet

Raclette Spatula

unlacquered smooth beechwood, not dishwasher proof



Spaghettiheber

Serie BUFFET ONE, aus Edelstahl 18/10, fugenlos, hochglänzend poliertes Arbeitsteil, seidenmatt polierter, angewinkelter Stiel

Spaghetti Server

BUFFET ONE range, 18/10 stainless steel, one piece, mirror polished, satin polished angled handle

18/10
EDELSTAHL
STAINLESS STEEL



Art-Nr. Part No.	Löffelmaß Bowl Size cm	Länge gesamt Total Length cm
3359/315	10 x 6,5	31,5

Spaghettiheber

Serie POLARIS, seidenmatt polierter Griff, ganz aus Edelstahl 18/10, hochglänzend

Spaghetti Server

with hanging loop, mirror polished with, satin polished handle, all 18/10 stainless steel

18/10
EDELSTAHL
STAINLESS STEEL



Art-Nr. Part No.	Löffelmaß Bowl Size cm	Länge gesamt Total Length cm
944/300	8 x 7	30

Spaghettiheber

Serie ERGONOM, aus Edelstahl 18/0, hochglänzend, ergonomisch profilierter Griff aus Edelstahl 18/10, fugenlos

Spaghetti Server

18/10 stainless steel handle, 18/0 stainless steel bowl, one piece, mirror polished finish

18/10
EDELSTAHL
STAINLESS STEEL

18/0
EDELSTAHL
STAINLESS STEEL



Art-Nr. Part No.	Löffelmaß Bowl Size cm	Länge gesamt Total Length cm
7791/310	8 x 6,5	31

Spaghettiheber

aus Edelstahl 18/10, hochglänzend, mit 3 mm starkem, seidenmatt polierten Stiel extra schwere Qualität

Spaghetti Server

18/10 stainless steel, mirror polished, with 3 mm thick satin polished handle, one piece, extra heavy gauge

18/10
EDELSTAHL
STAINLESS STEEL



Art-Nr. Part No.	Löffelmaß Bowl Size cm	Länge gesamt Total Length cm
1860/290	7 cm	32 cm

Spaghettiheber

aus Edelstahl, fugenlos, hochglänzend, mit Hakengriff

Spaghetti Server

stainless steel, one piece, mirror polished finish

INOX
EDELSTAHL
STAINLESS STEEL



Art-Nr. Part No.	Löffelmaß Bowl Size cm	Länge gesamt Total Length cm
1887/340	10 x 7	34

Spaghettiheber, lang

aus Edelstahl, schwere Qualität

Large Spaghetti Server

stainless steel, heavy gauge

INOX
EDELSTAHL
STAINLESS STEEL



Art-Nr. Part No.	Schaufelmaß Scoop dimension cm	Länge gesamt Total Length cm
1809/480	10 x 8,5	48

Art-Nr. Part No.	Löffelmaß Bowl Size cm	Länge gesamt Total Length cm
8951/320	10 x 7	32



Spaghettiheber

Serie BUFFET NOIR, mit Griff aus schwarzem Polyamid, Arbeitsteil aus Edelstahl, temperaturbeständig bis +120°C, spülmaschinengeeignet

Spaghetti Lifter

BUFFET NOIR range, stainless steel, with black polyamide handle, heat resistant up to +120°C, dishwasher safe



Art-Nr. Part No.	Länge Length cm
173/200	20



Spaghetzzange

aus Edelstahl 18/0, fugenlos, mit Lasche am Griffende zum Auflegen auf den Gefäßbrand

Spaghetti Tongs

18/0 stainless steel, one piece



Art-Nr. Part No.	Länge Length cm
3493/001	24



Spaghetzzange

aus Edelstahl, hochglänzend, fugenlos

Spaghetti Tongs

stainless steel, mirror polished finish, one piece



Art-Nr. Part No.	Länge Length cm
5633/270	27



Spaghetzzange

aus hochglänzendem Edelstahl 18/10

Spaghetti Tongs

18/10 stainless steel, mirror polished



Art-Nr. Part No.	Länge Length cm
511/300	30



Spaghetzzange

aus Edelstahl 18/10, hochglänzend, mit Stopper speziell zum Einsatz in Chafing Dishes, schwere Qualität

Buffet Tongs

18/10 stainless steel, mirror polished finish, heavy gauge



Art-Nr. Part No.	Länge Length cm
5635/310	31



Spaghetzzange, extra lang

aus Edelstahl, extra lange Ausführung zum Greifen in tiefe Nudeltöpfe

Spaghetti Tongs, long

stainless steel



Bratzange

aus Edelstahl 18/0, hochglänzend, mit Feder und Verschlusschieber, Greifer aus schwarzem Polyamid ermöglicht einen kratzfreien Einsatz in beschichteten Kochgeschirren, spülmaschinengeeignet, temperaturresistent bis +220°C, schwere Qualität



Art-Nr. Part No.	Länge Length
217/230	23 cm
217/300	30 cm
217/400	40 cm

Scalloped Tongs

18/0 stainless steel, mirror polished finish, with spring and retaining clip, the black polyamide blade avoids scratching of cookware, heat resistant up to +220°C, dishwasher proof, heavy gauge



Küchenzange

aus 0,8 mm starkem Edelstahl, hochglänzend, mit Feder und Verschlusschieber, dekorative Greiferform, mittelschwere Qualität



Art-Nr. Part No.	Länge Length
1450/240	24 cm
1450/300	30 cm
1450/400	40 cm

Scalloped Tongs

0.8 mm thick stainless steel, mirror polished finish, with spring and retaining clip, heavy gauge



Küchenzange

aus 0,9 mm starkem Edelstahl 18/10, seidenmatt gebürstet, mit Feder und kunststoffummanteltem Zugverschluss, mittelschwere Qualität



Art-Nr. Part No.	Länge Length
1451/230	23 cm
1451/300	30 cm
1451/400	40 cm

Scalloped Tongs

0.9 mm thick 18/10 stainless steel, satin polished finish, with spring and black rubber coated lock



Küchenzange

aus Edelstahl, mit schwarzem Vinyl-ummantelten Griff, mittelschwere Qualität



Art-Nr. Part No.	Länge Length
1453/240	23,5 cm
1453/300	30 cm
1453/400	40 cm

Scalloped Tongs

stainless steel, mirror polished finish, black vinyl coated handle



Küchenzange HACCP

aus Edelstahl, mit farbigem Vinyl-ummantelten Griff, schwere Qualität

Scalloped Tongs

stainless steel, mirror polished handle, HACCP coloured vinyl coated handle heavy gauge



Art-Nr. Part No.	Länge Length cm	Farbe Colour
1454/241	24	weiß/white
1454/242	24	gelb/yellow
1454/243	24	blau/blue
1454/244	24	braun/brown
1454/246	24	grün/green
1454/248	24	violett/purple
1454/249	24	rot/red
1454/301	30	weiß/white
1454/302	30	gelb/yellow
1454/303	30	blau/blue
1454/304	30	braun/brown
1454/306	30	grün/green
1454/308	30	violett/purple
1454/309	30	rot/red

Art-Nr. Part No.	Länge Length cm
3200/230	23



Küchenzange

aus Edelstahl, hochglänzend, vinyl-ummantelter Griff, hitzeresistent bis +120°C

Tongs

stainless steel, mirror polished finish, black vinyl coated handle, heat resistant up to +120°C



Art-Nr. Part No.	Länge Length cm
181/200	20 cm
181/250	25 cm
181/300	30 cm



Koch-Pinzette

aus Edelstahl, schwere Qualität, die gerändelte Grifffläche ermöglicht ein gezieltes Aufnehmen und Servieren von Speisen

Chefs Tongs / Tweezers

stainless steel, mirror polished finish, heavy gauge, the grooved surface enables easy lifting and serving



Art-Nr. Part No.	Länge Length cm
229/295	29,5 cm



Koch-Pinzette

aus glasfaserverstärktem Polyamid, mit kreuzgerändelter Grifffläche, temperaturresistent bis +240°C, besonders geeignet für Antihaft-Oberflächen

Chefs Tongs / Tweezers

fibreglass enforced polyamide, heat resistant up to +240°C, especially for use on non-slip surfaces



Art-Nr. Part No.	Länge Length cm
193/200	20



Koch-Pinzette

aus Edelstahl

Chefs Tongs / Tweezers

stainless steel



Art-Nr. Part No.	Länge Length cm
185/160	16



Dekorations-Pinzette

aus Edelstahl, gekrümmte Spitze

Sushi Tweezers

stainless steel



Art-Nr. Part No.	Länge Length cm
3479/190	19
3479/285	28,5



Koch-Pinzette

ganz aus schwarzem Polyamid, hitzebeständig bis +220°C, lebensmittelgeeignet, mit gerillter Greiffläche

Chefs Tongs / Tweezers

black polyamide, heat resistant up to +220°C, food safe



Grillzange

aus 1,5 mm starkem Edelstahl 18/10, hochglänzend, mit seidenmattem ovalen Rohrgriff, gezahnte Greifer, hochwertige Qualität

Barbecue Tongs

1.5 mm thick 18/10 stainless steel, mirror polished, with satin polished oval handles, serrated blades, heavy gauge



Art-Nr.	Länge
Part No.	Length
5660/420	42 cm

Grillzange

aus Edelstahl 18/10, hochglänzend, mit Rohrgriff, eine gezahnte Zangenfläche erleichtert das Greifen, extra hochwertige und robuste Qualität

Perforated Steak Tongs

18/10 stainless steel, with tubular handles and one blade serrated, mirror polished finish, heavy gauge, high quality



Art-Nr.	Länge
Part No.	Length
5686/510	53 cm

Grillzange

aus Edelstahl, hochglänzend, mit Rohrgriff, eine gezahnte Zangenfläche erleichtert das Greifen, schwere Qualität

Steak Tongs

stainless steel, with tubular handles and one blade serrated, mirror polished finish



Art-Nr.	Länge
Part No.	Length
5685/380	38 cm

Wurst-/ Grillzange

aus Edelstahl 18/10, hochglänzend, fugenlos, gerade Ausführung, schwere Qualität

Sausage Tongs

18/10 stainless steel, mirror polished finish, heavy gauge



Art-Nr.	Breite	Länge gesamt
Part No.	Width	Total Length
5665/370	1,5 cm	37 cm

Wurst-/ Grillzange

aus Edelstahl 18/10, hochglänzend, fugenlos, ideal zum Wenden von Bratwürsten u.ä., schwere Qualität

Sausage Tongs

18/10 stainless steel, mirror polished finish, heavy gauge



Art-Nr.	Breite	Länge gesamt
Part No.	Width	Total Length
5666/350	1,5 cm	35 cm

Wurst-/ Grillzange

aus Edelstahl 18/10, fugenlos

Sausage Tongs

18/10 stainless steel, one piece



Art-Nr.	Länge
Part No.	Length
198/160	16 cm
198/240	24 cm

Art-Nr.	Länge
Part No.	Length
209/190	19 cm
209/230	23 cm
209/260	26 cm
209/300	30 cm
209/350	35 cm
209/380	38 cm



Grillzange

aus Edelstahl 18/10, 5 mm Drahtstärke, Greiffläche geriffelt, mit Gelenk, spülmaschinenfest

Barbecue Tongs

18/10 stainless steel, 5 mm thick, with ridged blades, dishwasher safe



Art-Nr.	Länge
Part No.	Length
211/230	23 cm
211/300	30 cm



Grillzange

aus Edelstahl 18/0, 4,5 mm Drahtstärke, mit Gelenk, spülmaschinengeeignet

Barbecue Tongs

18/0 stainless steel, 4,5 mm thick, dishwasher safe



Art-Nr.	Länge
Part No.	Length
6335/230	26 cm



Grillzange

hochglanzverchromter Draht, mit vinyl-ummanteltem Griff, mit Gelenk, nicht spülmaschinengeeignet

Barbecue Tongs

chrome plated wire, vinyl coated handles, not dishwasher safe



Art-Nr.	Länge
Part No.	Length
5656/225	22,5 cm



Bratzange

aus Edelstahl 18/0, hochglänzend, fugenlos, perforiert, gut geeignet für Frikadellen, Hamburger-Sandwich u.ä., schwere Qualität

Burger Tongs

18/0 stainless steel, mirror polished finish, perforated, one piece



Art-Nr.	Länge
Part No.	Length
5625/220	22 cm



Bratzange

aus Edelstahl 18/0, hochglänzend, perforiert, fugenlos, schwere Qualität

Perforated Sandwich Tongs

18/0 stainless steel, mirror polished finish, perforated, one piece, heavy gauge



Art-Nr.	Länge
Part No.	Length
175/260	26 cm



Bratzange

aus Edelstahl 18/10, hochglänzend, geschlitzt, fugenlos, schwere Qualität

Slotted Tongs

18/10 stainless steel, mirror polished finish, slotted, one piece, heavy gauge



Fischzange

aus Edelstahl 18/10, hochglänzend, geschlitzt, fugenlos, schwere Qualität

Slotted Tongs

18/10 stainless steel, mirror polished, one piece, heavy gauge



Art-Nr. Part No.	Länge Length
366/260	26 cm

Fischzange

aus Edelstahl 18/0, hochglänzend, fugenlos, gelocht, schwere Qualität, ideal zum Greifen, Wenden und Servieren von Fisch

Perforated Fish Tongs

18/0 stainless steel, mirror polished finish, perforated, one piece, heavy gauge



Art-Nr. Part No.	Greiffläche Grip size cm	Länge gesamt Total Length cm
5677/225	7,5 x 6,5	24

Fischzange

längs perforiert, aus Edelstahl, hochglänzend

Slotted Fish Tongs

stainless steel, mirror polished finish



Art-Nr. Part No.	Greiffläche Grip size cm	Länge gesamt Total Length cm
178/235	11 x 6,5	23,5

Fischzange

aus Edelstahl 18/0, hochglänzend, fugenlos, gelocht, schwere Qualität

Fish Tongs

18/0 stainless steel, mirror polished finish, perforated, heavy gauge



Art-Nr. Part No.	Greiffläche Grip size cm	Länge gesamt Total Length cm
5678/150	15 x 7	24

Heringszange

aus unbehandeltem naturbelassenen Buchenholz, nicht spülmaschinengeeignet

Wooden Tongs

unlacquered smooth beechwood, not dishwasher proof



Art-Nr. Part No.	Breite Width	Länge gesamt Total Length
839/030	2 cm	30 cm
839/040	2 cm	40 cm

Gurkenzange

aus unbehandeltem naturbelassenen Buchenholz, mit Gelenk, nicht spülmaschinengeeignet

Wooden Spaghetti Tongs

unlacquered, smooth beechwood, not dishwasher proof



Art-Nr. Part No.	Breite Width	Länge gesamt Total Length
838/028	2 cm	28 cm

Art-Nr. Part No.	Länge Length
177/230	23 cm



Vorlegezange

aus Edelstahl, hochglänzend, schwere Qualität

General Tongs

stainless steel, mirror polished finish, heavy gauge



Art-Nr. Part No.	Löffelmaß Bowl Size	Länge gesamt Total Length
218/270	8 x 5 cm	27 cm



Vorlegezange

aus Edelstahl 18/10, hochglänzend, fugenlos, schwere Qualität

Buffet Tongs

18/10 stainless steel, mirror polished finish, one piece, heavy gauge



Art-Nr. Part No.	Länge Length
514/195	19,5 cm
514/245	24,5 cm



Vorlegezange

aus 2,6 mm starkem Edelstahl 18/0, hochglänzend, fugenlos, schwere Qualität

Serving Tongs

2.6 mm thick 18/0 stainless steel, mirror polished finish, one piece, heavy gauge



Art-Nr. Part No.	Länge Length
221/210	21 cm



Vorlegezange

aus Edelstahl, fugenlos, hochglänzend poliert

Serving Tongs

stainless steel, one piece, mirror polished finish



Art-Nr. Part No.	Länge Length
5667/160	21 cm



Vorlegezange

aus Edelstahl 18/0, hochglänzend, fugenlos, schwere Qualität

Catering Tongs

18/0 stainless steel, mirror polished finish, one piece, heavy gauge



Art-Nr. Part No.	Länge Length
5631/270	27 cm



Vorlegezange

aus Edelstahl 18/10, hochglänzend, fugenlos, schwere Qualität

Serving Tongs

18/10 stainless steel, mirror polished finish, one piece, heavy gauge



Art-Nr. Part No.	Länge Length
186/235	23,5 cm



Vorlegezange

aus Edelstahl 18/0, hochglänzend

Serving Tongs

18/0 stainless steel, mirror polished finish



Servierzange

aus Edelstahl 18/0, hochglänzend, ideal zum Greifen, Wenden und Servieren

General Tongs

18/0 stainless steel, mirror polished finish

18/0
EDELSTAHL
STAINLESS STEEL



Art-Nr. Part No.	Länge Length
197/240	24 cm

Servierzange

aus Edelstahl 18/10, hochglänzend

Salad Tongs

18/10 stainless steel, mirror polished finish

18/10
EDELSTAHL
STAINLESS STEEL



Art-Nr. Part No.	Länge Length
199/240	24 cm

Servierzange

aus Edelstahl, hochglänzend, elegantes modernes Design, schwere Qualität

Salad Tongs

stainless steel, mirror polished finish, heavy gauge

INOX
EDELSTAHL
STAINLESS STEEL



Art-Nr. Part No.	Länge Length
184/240	24 cm

Servierzange

Serie BUFFET ONE, aus Edelstahl 18/10, hochglänzend polierter Arbeitsteil, angewinkelter seidenmatt polierter Stiel

Serving Tongs

BUFFET ONE range, 18/10 stainless steel, mirror polished, angled satin polished handle

18/10
EDELSTAHL
STAINLESS STEEL



Art-Nr. Part No.	Länge Length
3362/300	30 cm

Servierzange

aus Edelstahl 18/10, hochglänzend, fugenlos, schwere Qualität

Serving Tongs

18/10 stainless steel, mirror polished finish, one piece, heavy gauge

18/10
EDELSTAHL
STAINLESS STEEL



Art-Nr. Part No.	Länge Length
5632/230	23,5 cm

Servierzange

aus Edelstahl 18/10

Tongs

18/10 stainless steel

18/10
EDELSTAHL
STAINLESS STEEL



Art-Nr. Part No.	Länge Length
5636/180	18 cm

Servierzange

aus Edelstahl 18/10, hochglänzend poliert

Multipurpose Tongs

18/10 stainless steel, mirror polished finish

18/10
EDELSTAHL
STAINLESS STEEL



Art-Nr. Part No.	Länge Length
227/210	21 cm

Art-Nr.	Länge
Part No.	Length
5659/250	25 cm



Salatzange

aus Edelstahl 18/10, hochglänzend, mit Gelenk, schwere Qualität

Salad Tongs

18/10 stainless steel, mirror polished finish, heavy gauge



Art-Nr.	Länge
Part No.	Length
5668/250	25 cm



Salatzange

aus Edelstahl 18/10, hochglänzend, mit Gelenk, schwere Qualität

Salad Tongs

18/10 stainless steel, mirror polished finish, heavy gauge



Art-Nr.	Länge
Part No.	Length
180/250	25 cm



Salatzange

aus Edelstahl 18/10, hochglänzend, mit Gelenk

Salad Tongs

18/10 stainless steel, mirror polished finish



Art-Nr.	Länge
Part No.	Length
Transparent: / Clear:	
236/310	31 cm
Schwarz: / Black:	
236/311	31 cm



Salatzange

aus Polycarbonat, spülmaschinengeeignet, temperaturbeständig bis +95°C

Multi Purpose Tongs

polycarbonate, dishwasher safe, heat resistant up to +95°C



Art-Nr.	Länge
Part No.	Length
5360/165	15 cm
5360/240	23 cm
5360/305	30 cm



Salatzange

aus glasklarem Polycarbonat, spülmaschinengeeignet, temperaturbeständig bis +95°C

Salad Tongs

clear polycarbonate, dishwasher safe, heat resistant up to +95°C



Salatzange

aus Edelstahl, seidenmatt gebürstet, fugenlos, schwere Qualität

Salad Tongs

stainless steel, satin polished finish, one piece, heavy gauge



Art-Nr. Part No.	Länge Length
219/220	22 cm

Salatzange

aus Edelstahl 18/10, hochglänzend, fugenlos

Salad Tongs

18/10 stainless steel, mirror polished finish, one piece



Art-Nr. Part No.	Länge Length
5664/320	32 cm

Spargelzange

aus Edelstahl, hochglänzend

Asparagus Tongs

stainless steel, mirror polished finish



Art-Nr. Part No.	Länge Length
513/185	18,5 cm

Spargelzange

aus Edelstahl 18/10, hochglänzend, Griff aus Edelstahl 18/0, hochglänzend

Asparagus Tongs

18/10 stainless steel, with 18/0 stainless steel handle, mirror polished finish



Art-Nr. Part No.	Länge Length
172/203	20 cm

Aufschnittzange

aus Edelstahl 18/10, hochglänzend, mit Feder, zum Greifen von Einzelscheiben oder ganzen Aufschnittlagen

Sliced Meat Tongs

18/10 stainless steel, mirror polished finish, with spring



Art-Nr. Part No.	Länge Length	Breite Width
189/105	10,5 cm	5 cm

Brotzange

aus Edelstahl 18/10, hochglänzend, fugenlos, schwere Qualität

Bread/Buffer Tongs

18/10 stainless steel, mirror polished finish, one piece, heavy gauge



Art-Nr. Part No.	Löffelmaß Bowl Size	Länge gesamt Total Length
5630/250	5 x 8 cm	25 cm

Art-Nr.	Länge
Part No.	Length
238/180	18 cm



Toastzange

aus Edelstahl, hochglänzend poliert

Sandwich Tongs

stainless steel, mirror polished finish



Art-Nr.	Länge
Part No.	Length
5627/230	23 cm



Muffinzange

aus Edelstahl 18/10, matt poliert, zum Greifen von vorzugsweise runden oder zylindrischen Lebensmitteln von etwa 4 - 8 cm Breite

Muffin Tongs

18/10 stainless steel, matt polished, grips round and cylindrical food of about 4-8 cm dia.



Art-Nr.	Länge
Part No.	Length
98/195	19,5 cm



Gebäckzange

längs perforiert, aus Edelstahl, hochglänzend

Slotted Tongs

stainless steel, mirror polished finish



Art-Nr.	Länge
Part No.	Length
174/180	18 cm



Gebäckzange

aus Edelstahl 18/10, hochglänzend, fugenlos, mit verziertem Griff, mit Gelenk, schwere Qualität

Pastry Tongs

18/10 stainless steel, mirror polished finish, with decorated handle, heavy gauge



Art-Nr.	Länge
Part No.	Length
187/175	17,5 cm



Gebäckzange

aus Edelstahl, hochglänzend, fugenlos, mit Gelenk, mit glattem Griff

Pastry Tongs

stainless steel, mirror polished finish, with plain handle



Art-Nr.	Länge
Part No.	Length
176/200	20 cm



Gebäckzange

aus Edelstahl 18/10, hochglänzend, mit Gelenk, mit ergonomischem Griff

Pastry Tongs

18/10 stainless steel, mirror polished finish



Eiszange

aus Edelstahl 18/10, hochglänzend, fugenlos

Serrated Ice Tongs

18/10 stainless steel, mirror polished finish, one piece



Art-Nr.	Länge
Part No. 179/180	Length 18 cm

Eiszange

aus Edelstahl, hochglänzend, fugenlos

Ice Tongs

stainless steel, mirror polished finish, one piece



Art-Nr.	Länge
Part No. 182/180	Length 18 cm

Eiszange

aus Edelstahl 18/10, hochglänzend, fugenlos, schwere Qualität

Serrated Ice Tongs

18/10 stainless steel, mirror polished finish, one piece, heavy gauge



Art-Nr.	Länge
Part No. 164/160	Length 16 cm

Eiszange

aus Edelstahl, außen matt poliert, fugenlos

Ice Tongs

stainless steel, satin finished outside, one piece



Art-Nr.	Länge
Part No. 2370/140	Length 14 cm

Zuckerzange

aus Edelstahl 18/0, hochglänzend, fugenlos

Serrated Sugar Tongs

18/0 stainless steel, mirror polished finish, one piece



Art-Nr.	Länge
Part No. 171/135	Length 12 cm

Zuckerzange

Edelstahl, hochglänzend, fugenlos

Sugar Tongs

stainless steel, mirror polished finish, one piece



Art-Nr.	Länge
Part No. 183/115	Length 11,5 cm

Zuckerzange

aus Edelstahl 18/0, fugenlos, Greifer mit Muscheldecor

Sugar Tongs

18/0 stainless steel, one piece



Art-Nr.	Länge
Part No. 1455/105	Length 10,5 cm

Zuckerzange

Besteckserie LOUISA, aus Edelstahl 18/10, hochglänzend, fugenlos

Sugar Tongs

18/10 stainless steel, mirror polished finish, one piece



Art-Nr.	Länge
Part No. 1999/077	Length 10,5 cm



Art-Nr. Part No.	Länge gesamt Total Length cm	∅ Rohr ∅ Tube cm
1889/455	45,5	1,4



Hängeleiste

aus Edelstahl, hochglänzend, stabile Qualität

Hanging Rack

stainless steel, mirror polished finish, heavy gauge

Art-Nr. Part No.	Löffelmaß Bowl Size cm	Stiellänge Handle Length cm
1881/090	0,1 l 9,8 x 9,8	30



Schöpfkelle

aus Edelstahl, fugenlos, hochglänzend, mit Hakengriff, ohne Maßstempelung, schwere Qualität

Soup Ladle

stainless steel, mirror polished finish, one piece, heavy gauge

Art-Nr. Part No.	Löffelmaß Bowl Size cm	Länge gesamt Total Length cm
1882/350	10 x 7	35



Servierlöffel

aus Edelstahl, fugenlos, hochglänzend, mit Hakengriff, schwere Qualität

Serving Spoon

stainless steel, mirror polished finish, heavy gauge

Art-Nr. Part No.	Löffelmaß Bowl Size cm	Länge gesamt Total Length cm
1883/350	10 x 7	35



Servierlöffel, längs perforiert

aus Edelstahl, fugenlos, hochglänzend, mit Hakengriff, schwere Qualität

Slotted Serving Spoon

stainless steel, mirror polished finish, heavy gauge

Art-Nr. Part No.	∅ dia. cm	Länge gesamt Total Length cm
1884/010	10	36,5



Schaumlöffel

aus Edelstahl, fugenlos, hochglänzend, mit Hakengriff, Lochdurchmesser 3 mm

Skimmer

stainless steel, mirror polished finish, with 3 mm perforations

Art-Nr. Part No.	Löffelmaß Bowl Size cm	Länge gesamt Total Length cm
1887/340	10 x 7	34



Spaghettiheber

aus Edelstahl, fugenlos, hochglänzend, mit Hakengriff

Spaghetti Server

stainless steel, one piece, mirror polished finish

Art-Nr. Part No.	Spatelmaß Blade cm	Länge gesamt Total Length cm
1886/380	10 x 7,5	38



Bratenwender, längs perforiert

aus Edelstahl, fugenlos, hochglänzend, mit Hakengriff

Slotted Slice

stainless steel, one piece, mirror polished finish

Art-Nr. Part No.	Zinkenlänge Prongs Length cm	Länge gesamt Total Length cm
1885/350	6,5	35



Fleischgabel

aus Edelstahl, fugenlos, hochglänzend, mit Hakengriff, schwere Qualität

Meat Fork

stainless steel, one piece, mirror polished finish, heavy gauge

Polaris

Die Serie Polaris bietet einen breiten Bereich an formschönen Küchenwerkzeugen und Servierutensilien zu einem hervorragendem Preis-Leistungsverhältnis.

Polaris

The Polaris series offers a wide range of elegant kitchen tools and serving utensils that represent great value for money.

Die Serie Polaris ist von robuster Qualität und spülmaschinenfest. Die Arbeitsteile sind zumeist aus hochwertigem, hochglänzenden Edelstahl 18/10 gefertigt; die Schneidwerkzeuge aus rostfreien Edelstahl 18/10. Alle Teile haben einen 10 cm langen seidenmatt polierten Griff aus rostfreien Edelstahl 18/10 und sind mit einer kräftigen Öse zum Aufhängen versehen. Der Übergang zwischen Griff und Arbeitsteil ist 100% wasserdicht.

The Polaris range is of robust quality and dishwasher-safe. The working parts are mostly made of high quality, mirror polished 18/10 stainless steel; the cutting tools are made of stainless blade steel. All items have a 10 cm long satin polished handle made of 18/10 stainless steel and are provided with a strong hanging loop. The seal between handle and blade is 100% watertight.



- sehr vielseitig
- Griffe aus Edelstahl 18/10
- schwere, robuste Qualität
- spülmaschinenfest
- starke Aufhängeösen
- *huge range*
- *tubular handles*
- *tough and robust*
- *dishwasher safe*
- *strong hanging loops*

Hängeleiste

mit verschiebbaren Haken, ganz aus Edelstahl 18/10

Hanging Rack



Art-Nr. Part No.	Länge Length cm	Breite Width cm
Mit 6 Haken: / With 6 hooks:		
995/330	33,5	2,3
Mit 10 Haken: / With 10 hooks:		
995/700	70	2,3
995/901	Zusätzliche Haken / Extra hooks	

Schöpfkelle, oval

ganz aus Edelstahl 18/10, hochglänzend

Soup Ladle

all 18/10 stainless steel



Art-Nr. Part No.	Löffelmaß Bowl Size cm	Stiellänge Handle Length cm
960/300	0,06 l 6 x 7	23
960/320	0,1 l 8 x 9	24

Saucengießlöffel

ganz aus Edelstahl 18/10, mit einseitiger Ausgusschnaupe

Sauce/Gravy Ladle

all 18/10 stainless steel, with one pouring lip



Art-Nr. Part No.	Löffelmaß Bowl Size cm	Stiellänge Handle Length cm	
974/280	7 x 5	21	0,02 l



Art-Nr. Part No.	∅ dia. cm	Länge gesamt Total Length cm
969/350	11	35



Schaumlöffel, rund

Löffel aus Edelstahl 18/0, hochglänzend

Skimmer

bowl 18/0 stainless steel mirror polished

Art-Nr. Part No.	Löffelmaß Bowl Size cm	Länge gesamt Total Length cm
970/350	11 x 10	33



Fisch-/ Schaumlöffel, oval

ganz aus Edelstahl 18/10, hochglänzend

Oval Skimmer / Fish Lifter

all 18/10 stainless steel

Art-Nr. Part No.	Schaufelmaß Scoop dimension cm	Länge gesamt Total Length cm
973/330	9 x 8,5	33



Woklöffel

ganz aus Edelstahl 18/10, hochglänzend

Chinese Spatula

all 18/10 stainless steel

Art-Nr. Part No.	Zinkenlänge Prongs Length cm	Länge gesamt Total Length cm
984/310	8	32



Tranchiergabel

Zinken aus hochglänzendem Edelstahl 18/0

Carving Fork

18/0 stainless steel prongs mirror polished

Art-Nr. Part No.	Zinkenlänge Prongs Length cm	Länge gesamt Total Length cm
985/330	9	30



Fleischgabel

ganz aus Edelstahl 18/10, hochglänzend

Fork

all 18/10 stainless steel mirror polished

Art-Nr. Part No.	Löffelmaß Bowl Size cm	Länge gesamt Total Length cm
971/300	8,5 x 7	30



Salat-/ Risottolöffel

ganz aus Edelstahl 18/10, hochglänzend

Salad Spoon

all 18/10 stainless steel

Art-Nr. Part No.	Löffelmaß Bowl Size cm	Länge gesamt Total Length cm
972/300	8,5 x 7	30



Salatgabel

ganz aus Edelstahl 18/10, hochglänzend

Salad Fork

all 18/10 stainless steel

Servierlöffel, längs perforiert

ganz aus Edelstahl 18/10, hochglänzend

Slotted Spoon

all 18/10 stainless steel



Art-Nr. Part No.	Löffelmaß Bowl Size cm	Länge gesamt Total Length cm
943/310	10 x 7,5	31

Servierlöffel

ganz aus Edelstahl 18/10, hochglänzende Laffe

Serving Spoon

all 18/10 stainless steel, mirror polished spoon



Art-Nr. Part No.	Löffelmaß Bowl Size cm	Länge gesamt Total Length cm
945/320	10 x 7,5	30,5

Servierlöffel, oval, perforiert

ganz aus Edelstahl 18/10

Perforated Spoon

all 18/10 stainless steel



Art-Nr. Part No.	Löffelmaß Bowl Size cm	Länge gesamt Total Length cm
901/310	9 x 6,5	31

Servierlöffel, oval

ganz aus Edelstahl 18/10, hochglänzende Laffe

Serving Spoon

all 18/10 stainless steel, mirror polished spoon



Art-Nr. Part No.	Löffelmaß Bowl Size cm	Länge gesamt Total Length cm
902/310	9 x 6,5	31

Servierlöffel, Polyamid

Arbeitsteil aus schwarzem Polyamid, spülmaschinen-geeignet, hitzebeständig bis +220°C, ideal für beschichtete Pfannen

Serving Spoon

black polyamide, dishwasher proof, heat resistant up to +220°C, for use with non-stick pans



Art-Nr. Part No.	Löffelmaß Bowl Size cm	Länge gesamt Total Length cm
910/310	10 x 6,5	31

Spaghettiheber

ganz aus Edelstahl 18/10, hochglänzend

Spaghetti Server

all 18/10 stainless steel



Art-Nr. Part No.	Löffelmaß Bowl Size cm	Länge gesamt Total Length cm
944/300	8 x 7	30

Servierlöffel

Löffel hochglänzend, ganz aus Edelstahl 18/10

Rice spoon

all 18/10 stainless steel



Art-Nr. Part No.	Löffelmaß Bowl Size cm	Länge gesamt Total Length cm
968/275	9,5 x 6,5	26



Art-Nr. Part No.	Spatelmaß Blade cm	Länge gesamt Total Length cm
904/090	9 x 7	34



Pfannenwender

ganz aus Edelstahl 18/10,
mit kurzem sehr stark angewinkeltem Blatt

Slice / Lifter

all 18/10 stainless steel

Art-Nr. Part No.	Spatelmaß Blade cm	Länge gesamt Total Length cm
909/130	13 x 7	38



Pfannenwender

ganz aus Edelstahl 18/10,
mit langem sehr stark angewinkeltem Blatt

Perforated Slice / Lifter

all 18/10 stainless steel

Art-Nr. Part No.	Spatelmaß Blade cm	Länge gesamt Total Length cm
977/330	8,5 x 8	33



Pfannenwender

Spatel aus hochglänzendem Edelstahl 18/0,
angewinkeltes Blatt

Slotted Slice

blade 18/0 stainless steel

Art-Nr. Part No.	Spatelmaß Blade cm	Länge gesamt Total Length cm
975/320	13 x 8	29



Pfannenwender

Spatel aus hochglänzendem Edelstahl 18/0,
leicht angewinkeltes Blatt

Slotted Slice

blade 18/0 stainless steel

Art-Nr. Part No.	Spatelmaß Blade cm	Länge gesamt Total Length cm
936/250	13,5 x 7	25



Pfannenwender

Spatel aus Edelstahl 18/0, hochglänzend,
vorderer Blattbereich angewinkelt

Egg Lifter

blade 18/0 stainless steel

Art-Nr. Part No.	Spatelmaß Blade cm	Länge gesamt Total Length cm
966/320	17 x 8	32



Pfannenwender

spülmaschinengeeignet, hitzebeständig bis +220°C,
gut geeignet für antihaft-beschichtete Pfannen

Slotted Egg Lifter

black polyamide blade especially for use on non-stick
pans heat resistant up to +220°C

Art-Nr. Part No.	Spatelmaß Blade cm	Länge gesamt Total Length cm
942/340	21 x 3	34



Konditorpalette

flexibler Spatel aus Edelstahl 18/0, hochglänzend

Palette Knife

flexible blade 18/0 stainless steel

Teigspatel

mit weichem Silikon-Spatel

Spatula

silicon blade



Art-Nr. Part No.	Spatelmaß Blade cm	Länge gesamt Total Length cm
976/290	9 x 5	29

Schneebeesen

ganz aus Edelstahl 18/10, 14 dünne Drähte

Whisk

all 18/10 stainless steel, 7 piano wires



Art-Nr. Part No.	Länge Length cm	∅ Draht ∅ Wire mm
949/200	22,5	1,4
949/250	27	1,4
949/300	32	1,4

Tellerschneebeesen

ganz aus Edelstahl 18/10, 8 dünne Drähte

Flat Whisk

all 18/10 stainless steel, 4 piano wires



Art-Nr. Part No.	Länge Length cm	∅ Draht ∅ Wire mm
940/210	21,5	1,4
940/260	26	1,4

Rührbesen, Polyamid

Drähte aus Polyamid, hitzeresistent bis +220°C, ideal für beschichtete Pfannen und Sauteusen

Whisk

polyamide head, heat resistant up to +220°C



Art-Nr. Part No.	Länge Length cm	∅ Draht ∅ Wire mm
907/310	31	4

Siebschaufel, groß

mit seidenmatt poliertem Griff aus Edelstahl, Arbeitsteil aus Polyamid

Perforated Scoop

with hanging loop, handle stainless steel, polyamide skimmer



Art-Nr. Part No.	Länge Length cm	∅ dia. cm

PRODUKTION
EINGESTELLT
PRODUCTION
DISCONTINUED

Passiersieb, spitz

ganz aus Edelstahl 18/10, mit breitem hochglänzenden Rahmen, Drahtstiel mit handlichem Rohrgriff, Gewebe extrafein, Maschenweite 0,6 mm, schwere Qualität

Strainer

wide mirror polished edge, all 18/10 stainless steel, extra fine mesh (12 holes/cm), heavy gauge



Art-Nr. Part No.	∅ außen ∅ Outside cm	Höhe Height cm	Stiellänge Handle Length cm	1 l
987/175	18	10	18	1 l

Kartoffelreibe

große Reibfläche aus hochglänzendem, geschärften Edelstahl 18/0

Potato Grater

blade 18/0 stainless steel



Art-Nr. Part No.	Fläche Size cm	Länge gesamt Total Length cm
991/300	10,5 x 9	30

Art-Nr. Part No.	Fläche Size cm	Länge gesamt Total Length cm
948/250	10 x 6	25



Muskatnussreibe

Reibfläche aus hochglänzendem Edelstahl 18/0, gewölbte Form

Nut Grater

curved blade 18/0 stainless steel

Art-Nr. Part No.	Fläche Size cm	Länge gesamt Total Length cm
962/032	11,5 x 6	24



Rohkost-/Bircherreibe

Reibfläche aus hochglänzendem Edelstahl 18/0

Vegetable Grater

blade 18/0 stainless steel

Art-Nr. Part No.	Fläche Size cm	Länge gesamt Total Length cm
947/235	11 x 6	23,5



Zitronen-/Parmesanreibe, extra fein

Reibfläche aus hochglänzendem Edelstahl 18/0

Zester/Parmesan Grater

blade 18/0 stainless steel

Art-Nr. Part No.	Klingenlänge Blade Length cm	Länge gesamt Total Length cm
954/190	7	19



Küchenmesser, glatt

mit ovalem Griff aus Edelstahl 18/10, Klinge aus Edelstahl 18/0

Paring Knife

blade 18/0 stainless steel

Art-Nr. Part No.	Klingenlänge Blade Length cm	Länge gesamt Total Length cm
955/225	8	22,5



Käsemesser

mit ovalem Edelstahl-Griff, glatte Klinge aus hochglänzendem Edelstahl 18/0

Cheese Knife

blade 18/0 stainless steel

Art-Nr. Part No.	Klingenbreite Blade Width cm	Klingenlänge Blade Length cm	Länge gesamt Total Length cm
950/250	2,5	15,5	27



Käsemesser

Klinge aus 1,5 mm Edelstahl 18/0, mit ovalem Griff aus Edelstahl 18/10, die Lochung verhindert das Festkleben der Käsescheiben an der Klinge, die Zinken ermöglichen das Aufnehmen der Scheiben

Cheese Knife

serrated blade 18/0 stainless steel, the perforation prevents cheese from adhering to the blade

Art-Nr. Part No.	Klingenlänge Blade Length cm	Klingenbreite Blade Width cm	Länge gesamt Total Length cm
932/210	8,5	4	20



Käse-/Hackbeil

Arbeitsteil aus Edelstahl 18/0, hochglänzend

Cheese Knife

blade 18/0 stainless steel

Käsehobel

Hobel aus Edelstahl 18/0, hochglänzend

Cheese Slicer

blade 18/0 stainless steel



Art-Nr. Part No.	Schneidbreite Cutting Width cm	Länge gesamt Total Length cm
933/200	5	18,5

Cocktailmesser

gezahnte Klinge aus hochglänzendem geschärften
Edelstahl 18/0, mit zwei Zinken zum Aufspießen von
Zitrusseiben

Bar Knife

blade 18/0 stainless steel serrated with two prongs



Art-Nr. Part No.	Länge Length cm	Klingenlänge Blade Length cm
994/220	22	10,5

Zitrusfruchtmesser mit Ziselierhaken

leicht gebogene Klinge aus Edelstahl 18/0,
feiner beidseitiger Sägeschliff, Ziselierhaken zum
Aufreißen der Schale

Grapefruit Knife

curved blade 18/0 stainless steel serrated



Art-Nr. Part No.	Länge Length cm	Klingenlänge Blade Length cm
908/210	21	10

Messerschärfer

sechs gehärtete Schleifradchen aus hochglänzendem
Edelstahl 18/0, mit Loch - daher auch zum Festschrau-
ben auf Arbeitsplatten geeignet

Knife Sharpener

18/0 stainless steel wheels,
with screw hole for table-top mounting



Art-Nr. Part No.	Länge Length cm	∅ Rädchen ∅ Wheel cm
979/190	19	2,5

Dosenlocher

mit extra spitzem Dorn (4 mm) aus Edelstahl 18/0

Tin/Can Punch

punch 18/0 stainless steel



Art-Nr. Part No.	Länge Length cm
965/130	13

Konservenöffner

Klinge aus Edelstahl 18/0, Bügel aus Edelstahl 18/10

Can Opener

blade 18/0 stainless steel



Art-Nr. Part No.	Länge Length cm
982/180	18

Deckelöffner

Arbeitsteil hochglänzend verchromt

Jar Opener

chrome plated opener



Art-Nr. Part No.	Länge Length cm	∅ max. cm
929/230	23,5	8



Art-Nr. Part No.	Länge Length cm
930/200	20



Dosenöffner
Arbeitsteil hochglänzend verchromt
Can Opener
chrome plated opener

Art-Nr. Part No.	Länge Length cm
925/185	18,5



Kapselheber / Dosenlocher
Arbeitsteil aus hochglänzendem Edelstahl 18/0
Bottle Opener
opener 18/0 stainless steel mirror polished

Art-Nr. Part No.	Länge Length cm	Schneidbreite Cutting Width cm
998/180	16	4,5



Gemüseschäler
hochglänzend, mit beweglicher Klinge
aus Edelstahl 18/0, handliches formschönes Design
Speed Peeler
blade 18/0 stainless steel

Art-Nr. Part No.	Länge Length cm	Klingenlänge Blade Length cm
922/185	18,5	5



Pendelschäler
Arbeitsteil aus Edelstahl 18/0, mit beweglicher Klinge,
für Rechtshänder
Swivel Peeler
blade 18/0 stainless steel

Art-Nr. Part No.	Länge Length cm	Klingenlänge Blade Length cm
961/200	20	4



Pendelschäler
mit beweglicher Klinge aus Edelstahl 18/0
Swivel Peeler
18/0 stainless steel flexible blade

Art-Nr. Part No.	Länge Length cm	Klingenlänge Blade Length cm
923/185	18,5	7



Sparschäler
Arbeitsteil aus Edelstahl 18/0
Peeler
blade 18/0 stainless steel

Art-Nr. Part No.	Länge Length cm	Schneidbreite Cutting Width cm
958/155	15,5	2



Fadenschneider
Arbeitsteil aus geschärftem Edelstahl 18/0,
hochglänzend
Zester
blade 18/0 stainless steel

Art-Nr. Part No.	Länge Length cm	Ø dia. cm
928/230	18	2,3
928/290	18,5	2,9



Kugelausstecher
ganz aus Edelstahl 18/10, matt poliert,
zum Ausstechen von Melonen, Kartoffeln usw.
Melon Baller
all 18/10 stainless steel

Apfelentkerner

Arbeitsteil aus Edelstahl 18/0, hochglänzend

Apple Corer

corer 18/0 stainless steel



Art-Nr. Part No.	Länge Length cm	Ø dia. cm
921/195	19,5	1,8

Knoblauchpresse

Arbeitsteil aus hochglänzendem Edelstahl 18/0, Einsatz herausnehmbar, 1,5 mm Lochung

Garlic Press

press 18/0 stainless steel with removable insert 1.5 mm perforations



Art-Nr. Part No.	Größe Size cm	Länge gesamt Total Length cm
931/160	3,5 x 2,5	17

Tomatenschneider

Sägen aus Edelstahl 18/0, ideal auch für Eier und Pilze

Tomato Slicer

18/0 stainless steel serrated blades



Art-Nr. Part No.	Fläche Size cm	Länge gesamt Total Length cm
978/295	15 x 9	29,5
Scheibendicke: 7 mm		
Slices: 7 mm		

Pellkartoffelgabel

mit drei Drahtzinken aus Edelstahl 18/10, Drahtdicke 1,4 mm, hochglänzend

Potato Fork

all 18/10 stainless steel, three prongs Ø 1.4 mm



Art-Nr. Part No.	Zinkenlänge Prongs Length cm	Länge gesamt Total Length cm
906/165	2,5	16,5

Kraut-/ Röstgabel

ganz aus Edelstahl 18/10, Zinken hochglänzend

Roasting/Lifting Fork

all 18/10 stainless steel



Art-Nr. Part No.	Zinkenlänge Prongs Length cm	Länge Length cm	Breite Width cm
959/100	13	30,5	10

Austernbrecher

eingelassene Klinge aus hochglänzendem Edelstahl 18/0, Materialstärke 1,8 mm, mit Fingerschutz

Oyster Knife

handle and guard 1.8 mm thick



Art-Nr. Part No.	Länge Length cm	Klingenlänge Blade cm
956/180	18	6

Eiertrenner

Arbeitsteil aus hochglänzendem Edelstahl 18/0, trennt schonend und sicher Eidotter von Eiweiß

Egg Separator

separator 18/0 stainless steel



Art-Nr. Part No.	Länge Length cm	Ø dia. cm
993/210	21	7

Teigrad

glattes Rädchen aus matt poliertem Edelstahl 18/0, mit Fingerschutz

Pastry Cutter

plain wheel 18/0 stainless steel with finger guard



Art-Nr. Part No.	Länge Length cm	Ø Rad Ø Wheel cm
934/057	18,5	5,7
934/067	19	6,7



Art-Nr. Part No.	Länge Length cm	∅ Rad ∅ Wheel cm
935/057	18,5	5,7



Teigrad

gewelltes Rädchen aus matt poliertem Klingenstahl, mit Fingerschutz

Pastry Cutter

fluted wheel 18/0 stainless steel with finger guard

Art-Nr. Part No.	Länge Length cm	∅ Rad ∅ Wheel cm
939/180	18	3,5



Teigrädchen

gewelltes Rädchen aus hochglänzend poliertem Edelstahl 18/0

Pastry Cutter

stainless steel fluted wheel

Art-Nr. Part No.	Fläche Size cm	Länge Length cm
983/155	6,5 x 6,5	15,5



Ravioliusstecher, quadratisch

Ausstecher aus hartverchromtem Zinkguss

Square Ravioli Cutter

chrome plated zinc alloy

Art-Nr. Part No.	Länge Length cm	∅ dia. cm
986/155	15,5	6



Ravioliusstecher, rund

Ausstecher aus hartverchromten Zinkguss

Round Ravioli Cutter

chrome plated zinc alloy

Art-Nr. Part No.	Löffelmaß Bowl Size cm	Länge gesamt Total Length cm
946/215	6 x 4	21,5



Eisdipper

Arbeitsteil aus hochglänzendem Edelstahl 18/0

Ice Cream Scoop

bowl 18/0 stainless steel suitable for soft scoop ice cream only

Art-Nr. Part No.	Spatelmaß Blade cm	Länge gesamt Total Length cm
937/255	10 x 5,5	26



Tortenheber, gezahnt

leicht gekröpfter Heber aus hochglänzendem Edelstahl 18/0, mit einer gezahnten Kante

Cake/Pie Lifter

blade 18/0 stainless steel one edge serrated slightly cranked

Art-Nr. Part No.	Spatelmaß Blade cm	Länge gesamt Total Length cm
905/255	13,5 x 5	25,5



Tortenheber mit Messer

stark angewinkelter Spatel aus hochglänzendem Edelstahl 18/0, mit einer gezahnten Kante

Cake/Pie Knife/Lifter

blade 18/0 stainless steel mirror polished one edge serrated

Art-Nr. Part No.	Spatelmaß Blade cm	Länge gesamt Total Length cm
996/270	12 x 6	27



Tortenheber

ganz aus Edelstahl 18/10, hochglänzend, leicht gekröpfte Klinge

Cake/Pie Lifter

all 18/10 stainless steel

Dosenöffner, Standard

Gestell aus Edelstahl 18/0, Kurbel aus ABS, variabel für runde, ovale und abgerundete Dosen bis maximal 56 cm Höhe, für Tischplatten bis 6,5 cm, schwere Ausführung

Can Opener

18/0 stainless steel stem, ABS crank handle, adjustable for round or oval cans up to 56 cm height and work surfaces up to 6.5 cm thick, heavy gauge



Art-Nr.	Länge
Part No.	Length
339/075	75 cm
Tischauflage: 25 x 10 x 1,5 cm	
Clamp size: 25 x 10 x 1.5 cm	

339/901	Radausrüstung / Wheel
339/902	Ersatzmesser / Spare blade

Weitere Ersatzteile auf Anfrage.
Other spare parts on request.

Dosenöffner, robust

mit größerer robuster Radausrüstung, Gestell aus Edelstahl 18/0, Kurbel aus ABS, variabel für runde, ovale und abgerundete Dosen bis maximal 56 cm Höhe, für Tischplatten bis 6,5 cm, extra schwere Ausführung

Can Opener

with larger robust wheel, 18/0 stainless steel stem, ABS crank handle, adjustable for round or oval cans up to 56 cm height and work surfaces up to 6.5 cm thick, extra heavy gauge



Art-Nr.	Länge
Part No.	Length
346/075	75 cm
Tischauflage: 25 x 10,5 x 1,5 cm	
Clamp size: 25 x 10 x 1.5 cm	

346/901	Große Radausrüstung / Large wheel
339/902	Ersatzmesser / Spare blade

Weitere Ersatzteile auf Anfrage.
Other spare parts on request.

Dosenöffner

verchromt mit ABS-Griff, stabile Qualität

Can Opener

chrome plated with ABS handles



Art-Nr.	Länge
Part No.	Length
4690/180	18 cm

Dosenöffner

Serie POLARIS, mit seidenmatt polierten Griffen aus Edelstahl 18/10, Arbeitsteil hochglänzend verchromt, schwere Qualität

Can Opener

with hanging loops, handles 18/10 stainless steel, chrome plated opener



Art-Nr.	Länge
Part No.	Length
930/200	20 cm

Dosenöffner

hochglänzend verchromt

Can Opener

chrome plated, mirror finish



Art-Nr.	Länge
Part No.	Length
320/155	15,5 cm



Art-Nr.	∅ Rädchen	Länge
Part No.	∅ Wheel	Length
357/060	2,5 cm	6 cm

Bedienung: Griff nach links drehen, das Messer öffnet sich, an Dose anlegen und durch Rechtsdrehung schneiden.



Dosenöffner

für professionellen Einsatz, Messer und Rädchen aus gehärtetem, verzintem Stahl, mit handlichem Holzgriff, geeignet für große Dosen

Tin/Can Opener

professional design, for large tins, hardened tinned steel blade and wheel, wooden handle



Art-Nr.	Länge	Breite max.
Part No.	Length	Max. Width
356/170	17 cm	4 cm



Konservenöffner, groß

mit Kapselheber im Griff, große Ausführung für mehr Sicherheit und Effizienz im professionellem Dauereinsatz, aus 2 mm starkem verchromtem Stahl, schwere Qualität

Can / Bottle Opener

2 mm chrome plated steel, heavy gauge



Art-Nr.	Länge
Part No.	Length
982/180	18



Konservenöffner

Serie POLARIS, mit Griff aus Edelstahl 18/10, Klinge aus Edelstahl 18/0, Bügel aus Edelstahl 18/10

Can Opener

with hanging loop, blade 18/0 stainless steel, handle 18/10 stainless steel



Art-Nr.	Länge
Part No.	Length
965/130	13



Dosenlocher

Serie POLARIS, mit seidenmatt poliertem Griff aus Edelstahl 18/10, mit extra spitzem Dorn (∅ 4 mm, 25 mm lang) aus Edelstahl 18/0

Tin/Can Punch

with hanging loop, handle 18/10 stainless steel, punch 18/0 stainless steel (∅ 4 mm, 25 mm length)



Art-Nr.	Länge	Breite	Stärke
Part No.	Length	Width	Thickness
321/010	10,5 cm	2 cm	1,7



Dosenlocher / Kapselheber

vernickelter Stahl

Can / Bottle Opener

nickel plated steel



Art-Nr.	Länge	∅ max.
Part No.	Length	cm
929/230	23,5	8



Deckelöffner

Serie POLARIS, mit seidenmatt polierten Griffen aus Edelstahl 18/10, Arbeitsteil hochglänzend verchromt, schwere Qualität

Jar Opener

with hanging loops, handle 18/10 stainless steel, chrome plated opener



Fisch & Meer

Forelle blau, Sushi, Ceviche oder Poke. Das Meer liefert die Rohstoffe für viele Gerichte. **contacto** hat die Werkzeuge zur Bearbeitung und zum Genießen von Fisch und Schalentieren.

Fish & Seafood

Whatever the occasion, **contacto** has what you need for preparing and serving all types of fish and seafood dishes.

Hummerplatte

aus Edelstahl 18/0, hochglänzend, fugenlos, schwere Qualität

Lobster Dish

18/0 stainless steel, mirror polished finish, one piece, heavy gauge

18/0
EDELSTAHL
STAINLESS STEEL



Art-Nr. Part No.	Fläche Size cm	Länge Length cm
3800/590	28 x 20	59

Mit vergoldetem Kopf und Flosse auf Anfrage lieferbar.
With gold plated head and tail available on request.

Fischplatte

aus Edelstahl 18/0, hochglänzend, fugenlos, schwere Qualität

Fish Platter

18/0 stainless steel, mirror polished finish

18/0
EDELSTAHL
STAINLESS STEEL



Art-Nr. Part No.	Fläche Size cm	Länge Length cm
3801/940	50 x 26,5	94

Fischplatte

aus Edelstahl 18/10, mit gebördeltem Rand, Bodenfläche seidenmatt, schwere Qualität

Fish Platter

18/10 stainless steel, with rolled edge, satin polished base, heavy gauge

18/10
EDELSTAHL
STAINLESS STEEL



Art-Nr. Part No.	Länge Length cm	Breite Width cm	Höhe Height cm
5/055	55	24	3
5/070	75	29	2,4

Fischplatte

aus Edelstahl, hochglänzend poliert, mit gebördeltem Rand

Fish/Salmon Platter

stainless steel, mirror polished finish, with rolled edge

INOX
EDELSTAHL
STAINLESS STEEL



Art-Nr. Part No.	Länge Length cm	Breite Width cm	Höhe Height cm
3845/450	45	18	2,3
3845/600	60	24,5	2,3
3845/650	65	26	2,8
3845/750	75	28	2,8

Art-Nr. Part No.	Länge Length	Breite Width
195/155	15,5 cm	2 cm



Fischgrätenpinzette

aus Edelstahl 18/0, seidenmatt poliert, mit geriffelter Greiffläche, schwere Qualität

Salmon Tweezers

18/0 stainless steel, satin polished finish, with serrated tips, heavy gauge



Art-Nr. Part No.	Länge Length
196/150	15 cm



Fischgrätenzange

aus massivem Edelstahl 18/0, hochglänzend, mit gezahnter Greiffläche

Salmon Tweezers

18/0 stainless steel, mirror polished finish, with serrated tips



Art-Nr. Part No.	Länge Length	Fläche Size
2226/280	30 cm	8 x 6



Fischentschupper

aus Messerstahl, mit blauem ABS-Griff, schwere Qualität

Fish Scaler

stainless steel, with blue ABS handle, heavy gauge



Art-Nr. Part No.	Länge Length	Fläche Size
2227/230	23	8 x 4

Keine Ersatzmesser erhältlich.
No spare parts available.



Fischentschupper

aus gehärtetem Edelstahl 18/0, mit schwarzem glasfaserverstärkten Polyamid-Griff

Fish Scaler

hardened 18/0 stainless steel, one coarse and one fine saw, black fibreglass reinforced polyamide handle



Art-Nr. Part No.	Länge Length	Fläche Size
2218/260	26	10 x 5



Fischentschupper

aus Edelstahl 18/0, schwere Qualität

Fish Scaler

18/0 stainless steel, heavy gauge



Art-Nr. Part No.	Länge Length	Breite Width
2228/210	21 cm	5



Fischentschupper

aus Edelstahl, leichte stabile Qualität

Fish Scaler

stainless steel



Art-Nr. Part No.	Länge Length	Breite Width
2215/195	19,5	3



Fischentschupper

aus Edelstahl, leichte Ausführung

Fish Scaler

stainless steel



Hummerschere

aus massivem Edelstahl 18/0, hochglänzend, schwere Qualität

Lobster Cracker

18/0 stainless steel, mirror polished finish, heavy gauge

18/0
EDELSTAHL
STAINLESS STEEL



Art-Nr.
Part No.
275/190

Länge
Length
19 cm

Hummerschere

aus massivem Edelstahl 18/0, hochglänzend, schwere Qualität

Lobster Pliers

18/0 stainless steel, mirror polished finish heavy gauge

18/0
EDELSTAHL
STAINLESS STEEL



Art-Nr.
Part No.
277/185

Länge
Length
18,5 cm

Hummerbrecher

aus massivem Edelstahl 18/0, seidenmatt poliert, formschönes, handliches Design, schwere Qualität

Lobster Cracker

18/0 stainless steel, satin polished finish, elegant design, heavy gauge

18/0
EDELSTAHL
STAINLESS STEEL



Art-Nr.
Part No.
450/290

Länge
Length
19 cm

Hummerbrecher

aus Aluminiumguss, nicht spülmaschinengeeignet

Lobster Cracker

cast aluminium, not dishwasher proof

ALU
ALUMINIUM
CAST ALUMINIUM
SPÜLMASCHINENUNTAUGLICH
NOT DISHWASHER PROOF



Art-Nr.
Part No.
276/140

Länge
Length
14 cm

Hummergabel

aus 1,2 mm starkem Edelstahl 18/10, hochglänzend poliert, Hummer auf Medaillon abgebildet, hochwertige Qualität

Seafood Pick

1.2 mm thick 18/10 stainless steel, mirror polished finish, lobster design, heavy gauge

18/10
EDELSTAHL
STAINLESS STEEL



Art-Nr.
Part No.
278/001

Länge
Length
21 cm

Hummergabel

aus Edelstahl, seidenmatt poliert, Krabbe auf Medaillon abgebildet, schwere Qualität

Seafood Pick

stainless steel, crab design, satin polished finish

INOX
EDELSTAHL
STAINLESS STEEL



Art-Nr.
Part No.
279/001

Länge
Length
19,5 cm

Art-Nr. Part No.	∅ dia.	Höhe Height
39/240	24 cm	2 cm



Austernplatte

aus Edelstahl 18/0, hochglänzend poliert, für sechs Austern

Oyster Dish

18/0 stainless steel, mirror polished finish, for six oysters



Art-Nr. Part No.	Länge Length	Klingenlänge Blade Length
2220/140	14 cm	4,5 cm



Austernbrecher

aus Messerstahl, mit hell lackiertem Holzgriff und Fingerschutz

Oyster Knife

stainless steel, with guard, wooden handle



Art-Nr. Part No.	Länge Length	Klingenlänge Blade Length
2223/170	17 cm	5,5 cm



Austernbrecher

aus 3.2 mm starkem Edelstahl 18/0, hochglänzend poliert, Klinge extra geschärft, mit Fingerschutz, mit schwarzem glasfaserverstärkten Polyamid-Griff, schwere Profi-Qualität für höchste Belastung

Oyster Knife

3.2 mm thick 18/0 stainless steel, mirror polished finish, extra sharp, with finger guard, heavy gauge, professional quality, black fibreglass reinforced polyamide handle



Art-Nr. Part No.	Länge Length	Klingenlänge Blade
956/180	18 cm	6 cm



Austernbrecher

Serie POLARIS, mit seidenmatt poliertem Griff aus Edelstahl 18/10, eingelassene Klinge aus hochglänzendem Edelstahl 18/0, Materialstärke 1,8 mm, mit Fingerschutz

Oyster Knife

with 18/10 stainless steel handle and guard, mirror polished blade, 1.8 mm thick



Art-Nr. Part No.	Länge Length	Klingenlänge Blade Length
2222/165	16 cm	6,5 cm



Austernbrecher

aus Messerstahl, mit edlem Holzgriff und Messingring, extra schwere Qualität

Oyster Knife

stainless steel, with rosewood handle and brass ring, extra heavy gauge



Art-Nr. Part No.	Länge Length
2221/001	15 cm



Austerngabel

aus Edelstahl 18/10, matt, schwere Qualität

Oyster Fork

18/10 stainless steel, matt polished finish, heavy gauge



Art-Nr. Part No.	Länge Length
2224/012	13,5 cm



Austerngabel

aus Edelstahl 18/0, mit verziertem Griff

Oyster Fork

18/0 stainless steel, with decorated handle



Verpackung und Preis à 12 Stück.
Priced/packed in dozens.

Muschelserviertopf

innen und außen schwarz emailliert,
mit Edelstahl-Ring an Topf und Deckel

Mussels Pot

black enamelled inside and out,
with stainless steel rings



Art-Nr. Part No.	∅ dia. cm	Höhe gesamt Overall Height cm
Für ca. 0,3 kg Muscheln: / holds 0.3 Kg mussels:		
488/120	0,75 l	12
Für ca. 1 kg Muscheln: / holds 1.0 Kg mussels:		
488/180	2,5 l	18
Für ca. 1,5 kg Muscheln: / holds 1.5 Kg mussels:		
488/200	3,5 l	20

Muschelserviertopf

aus Edelstahl 18/10, hochglänzend,
ohne Kompensboden, der Deckel dient als Schüssel
zur Aufnahme der Muschelschalen

Mussels Pot

18/10 stainless steel, mirror polished finish,
lid serves as dish for empty mussel shells



Art-Nr. Part No.	∅ dia. cm	Höhe gesamt Overall Height cm
Für ca. 0,8 kg - 1 kg Muscheln: / holds 0.8-1 kg mussels:		
490/180	2,5 l	18

Servierlöffel, flach

aus Edelstahl 18/10, hochglänzend, fugenlos,
extra flache Form

Spoon

18/10 stainless steel, mirror polished finish,
very shallow bowl



Art-Nr. Part No.	∅ dia. cm	Länge gesamt Total Length cm
491/285	10 cm	28,5 cm

Meeresfruchtschale

aus Edelstahl 18/10, hochglänzend,
mit gebördeltem Rand, schwere Qualität

Seafood Tray

18/10 stainless steel, mirror polished finish,
rolled edge, heavy gauge



Art-Nr. Part No.	∅ dia. cm	Höhe Height cm	∅ Boden ∅ Base cm	∅ oben ∅ Top cm
7624/360	5 l	35	7	26

Buffet-Ständer für Meeresfruchtschale

aus doppelt hochglanzverchromtem 5 mm starkem
Stahldraht

Seafood Stand

5 mm thick chrome plated wire



Art-Nr. Part No.	Höhe Height cm	∅ Boden ∅ Base cm	∅ oben ∅ Top cm
7626/300	21	21	30

passend zur Schale 7624
for 7624 seafood tray

Kaviarkühler

dreiteilig, aus Edelstahl 18/10, hochglänzend,
schwere Qualität, mit zusätzlichem Einsatz (in rechter
Abbildung) auch als Butterkühlschale zu nutzen

Caviar/ Butter Dish

3 piece, 18/10 stainless steel, mirror polished finish,
heavy gauge, can be converted into a butter dish by
replacing caviar insert with perforated butter insert



Art-Nr. Part No.	∅ innen ∅ Inside cm	Höhe gesamt Overall Height cm	∅ außen ∅ Outside cm	
3288/150	8	9	15	0,15 l

Separater perforierter Butterkühlaufsatz: / Perforated butter insert:
3289/135



Art-Nr. Part No.	∅ dia. cm	Höhe Height cm
---------------------	-----------------	----------------------

Für sechs Schnecken: / For six snails:
38/006 13,5 1,5

Für zwölf Schnecken: / For twelve snails:
38/012 18 1,5



Schneckenplatte

aus Edelstahl 18/0, hochglänzend, schwere Qualität

Snail Dish

18/0 stainless steel, mirror polished finish, heavy gauge



Art-Nr. Part No.	∅ dia. cm	Höhe Height cm
---------------------	-----------------	----------------------

Für sechs Schnecken: / For six snails:
6885/006 13 2

Für zwölf Schnecken: / For twelve snails:
6885/012 18,5 2,5



Schneckenplatte

aus Edelstahl 18/10, hochglänzend, schwere Qualität

Snail Dish

18/10 stainless steel, mirror polished finish, heavy gauge



Art-Nr. Part No.	Länge Length
---------------------	-----------------

31/155 16,5 cm



Schneckenzange

aus Edelstahl 18/10, hochglänzend, schwere Qualität

Snail Tongs

18/10 stainless steel, mirror polished finish



Art-Nr. Part No.	Zinkenlänge Prongs Length	Länge gesamt Total Length
---------------------	------------------------------	------------------------------

30/155 4,5 cm 15,5 cm



Aufschnitt-/ Schneckengabel

aus Edelstahl 18/10, seidenmatt

Serving / Snail Fork

18/10 stainless steel, satin polished finish



Art-Nr. Part No.	Zinkenlänge Prongs Length	Länge gesamt Total Length
---------------------	------------------------------	------------------------------

32/150 3 cm 14 cm



Schneckengabel

aus Edelstahl 18/0, hochglänzend

Snail Fork

18/0 stainless steel, mirror polished finish



Art-Nr. Part No.	Länge Length cm	Breite Width cm
---------------------	-----------------------	-----------------------

4853/001 23 24



Sushi-Matte

aus Bambus

Sushi Mat

bamboo





Eisskulpturen

Mit Eisskulpturen holen Sie den glitzernden Chill der legendären Ice Bars auf Ihr Event. Das wird der eiskalte kristallklare Mittelpunkt vieler Abende.

Ice Sculpture Moulds

Easily create stunning ice features in these re-usable moulds and bring a real sparkle to that special event.

Mehrwegformen

aus weißem Polyethylen zur Herstellung von Eisskulpturen, außen mit orangefarbenem Spezialharz verstärkt. Die Formen lassen sich einfach mit Eiskwürfeln und Wasser befüllen und danach einfrieren. Nach zwischenzeitlichem Lockern der Schrauben kann die fertige Skulptur etwa 20 Stunden nach dem Einfrieren entnommen werden.

Re-Usable Ice Sculpture Moulds

white polyethylene, reinforced on the outside with a special orange coloured resin. The mould is easily filled with ice cubes and water. After 15 hours the screws have to be loosened and after 20 hours the mould is removed from the freezer, rested at room temperature, then unscrewed and the ice sculpture carefully removed.



- Eye-Catcher
- einfache Handhabung
- wiederverwendbar
- Farbeffekte möglich
- eye-catcher
- easy handling
- re-usable
- Colour effects possible

Eisskulpturform Schwan

Reusable Ice Sculpture Swan



Art-Nr. Part No.	Länge Length cm	Breite Width cm	Höhe Height cm
5858/001	42	26	53
5858/904	Pumpe / Pump		

Eisskulpturform Delfin

Reusable Ice Sculpture Dolphin



Art-Nr. Part No.	Länge Length cm	Breite Width cm	Höhe Height cm
5858/001	42	26	53
5858/904	Pumpe / Pump		

PRODUKTION
EINGESTELLT
PRODUCTION
DISCONTINUED

Eisskulpturform Muschel

Reusable Ice Sculpture Shell



Art-Nr. Part No.	Länge Length cm	Breite Width cm	Höhe Height cm
5858/004	48	56	15
5858/904	Pumpe / Pump		



Bäckerei & Konditorei

Die ganze Welt des Backens – vom Plätzchenausstecher über Teigschaber und Pralinenformen bis zur Pizzaschaukel. Bäcker, Konditoren und Chocolatiers finden hier das richtige Arbeitsgerät. Mit den Produkten von **contacto** wird Ihre Torte noch ein bisschen runder.

Pastry & Baking

Savoury, sweet, hot, cold, whatever the requirement from pastry cutters to chocolate moulds, chefs, bakers, confectioners and chocolatiers will find the right tools at Contacto.

Seite Page
216

Pizza & Pastabedarf
Pizza & Pasta Utensils

Seite Page
222

Backformen & Bleche
Baking Sheets & Moulds

Seite Page
230

Silikon-Backformen
Silicone Moulds

Seite Page
238

Backformen
Rings & Moulds

Seite Page
249

Backzubehör
Baking Utensils

Seite Page
270

Konfiserie & Schokolade
Chocolate & Confectionery

Seite Page
274

Konditorei
Cake Stands & Knives

Seite Page
281

Eiscafé
Ice Cream

Pizza- & Pastabedarf

Primi piatti: Pappardelle e Pizza arrotolata. Gelingt bestens mit Pizza- und Pastazubehör von **contacto**. Buon appetito!

Pizza & Pasta Utensils

Create pizza and pasta the Italian way with great **contacto** products.

Pizzablech

aus 0,7 mm Schwarzblech, mit gebördeltem Rand, nicht spülmaschinengeeignet. **Pizzableche müssen trocken und eingefettet gelagert werden!**

Pizza Pan

0.7 mm blue steel, rolled edge, not dishwasher safe. **Pizza pans must be kept dry and oiled with cooking oil, avoid metal utensils!**



Art-Nr. Part No.	Höhe Height cm	∅ Boden ∅ Base cm	∅ oben ∅ Top cm
1740/140	2,5	12,5	14
1740/160	2,5	14,5	16
1740/180	2,5	16,5	17,5
1740/200	2,5	18	20
1740/220	2,5	20	22
1740/240	2,5	21,5	24
1740/260	2,5	23,5	26
1740/280	2,5	25,5	28
1740/300	2,5	27,5	31
1740/320	2,5	30	33
1740/360	2,5	34	36
1740/400	2,5	37,5	39
1740/450	3,5	42,5	44,5
1740/500	3,5	47,5	51
1740/600	3,5	57,5	60

Pizzablech, rechteckig

aus 0,7 mm starkem Schwarzblech, mit umgelegtem verstärkten Rand, nicht spülmaschinengeeignet.

Pizzableche müssen trocken und eingefettet gelagert werden!

Rectangular Pizza Pan

0.7 mm thick blue steel, reinforced edge, not dishwasher proof. **Pizza pans must be kept dry and oiled with cooking oil, avoid metal utensils!**



Art-Nr. Part No.	Länge außen Outer Length cm	Breite außen Outer Width cm	Höhe Height cm
1745/400	40	30	3
1745/500	50	35	3

quadratische Maße: / square:

1745/501	50	50	3
1745/601	60	60	3

Backofenmaß 60 x 40 cm:

1745/600	60	40	3
----------	----	----	---

Antihaft-Pizzablech

aus zweifach PTFE-beschichtetem Stahlblech, mit gebördeltem Rand, hitzeresistent bis +230°C, nicht spülmaschinengeeignet

Pizza Pan

with PTFE non-stick double coated blue steel, rolled edge, heat resistant up to 230°C, not dishwasher safe



Art-Nr. Part No.	Höhe Height cm	∅ Boden ∅ Base cm	∅ oben ∅ Top cm
1741/200	2,5	18,5	20
1741/240	2,5	21,5	24
1741/260	2,5	24	26
1741/280	2,5	26,5	28
1741/320	2,5	30,5	32



Art-Nr. Part No.	Höhe Height cm	∅ Boden ∅ Base cm	∅ oben ∅ Top cm
6315/350	1	30	31,5



Antihaft-Pizzablech, perforiert

aus 0,6 mm starkem Stahl, PTFE antihaft-beschichtet, hitzeresistent bis +230°C, mit eingepressten Füßchen, 8 mm Lochdurchmesser, ideal auch für Tiefkühl-Pizza, nicht spülmaschinengeeignet

Perforated Pizza Pan

steel 0.6 mm thick with PTFE non-stick coating, heat resistant up to 230°C, 8 mm holes diameter, with built-in feet, not dishwasher safe



Art-Nr. Part No.	Höhe Height cm	∅ Boden ∅ Base cm	∅ außen ∅ Outside cm
1742/240	1	20,5	25,5
1742/280	1	23	28
1742/320	1	27,5	33,5
1742/360	1	30,5	36
1742/410	1	35,5	41



Gelochtes Pizzablech

aus Aluminium, 10 mm Lochdurchmesser, nicht spülmaschinengeeignet, für extra knusprige Pizzaböden, ideal auch für tiefgekühlte Pizza

Perforated Pizza Pan

aluminium, with 10 mm diameter perforations, not dishwasher safe



Art-Nr. Part No.	∅ dia. cm
1747/200	20
1747/230	23
1747/250	25
1747/280	28
1747/300	30
1747/330	33
1747/360	36
1747/380	38
1747/400	40
1747/450	45
1747/500	50



Pizza Screen/Gitter

aus Aluminium-Streckmetall, nicht spülmaschinengeeignet, beschleunigt die Krustenbildung

Pizza Screen

aluminium, not dishwasher safe



Art-Nr. Part No.	Höhe Height cm	Fläche Size cm	Ablagehöhe Rack height cm	Anzahl Fächer Slots
für tiefe Teile / for deep parts				
1763/011	69	22	6	11

für flache Teile / for shallow parts				
1763/015	69	22	4	15
Anzahl der Fächer einschließlich unterste Ebene. Number of layers includes the bottom one.				



Pizzablechhalter

aus verchromtem Draht, steht selbständig, zur Ablage von Pizza- und Kuchenblechen bis maximal 50 cm Durchmesser

Pizza Pan Rack

chrome-plated wire, for maximum 50 cm dia. pizza pans and baking sheets



Zange für Pizzableche

aus Edelstahl 18/10, hochglänzend, mit Feder, zum Greifen heißer Back- und Pizzableche

Pan Gripper

18/10 stainless steel, mirror polished finish, with spring, heavy gauge



Art-Nr. Part No.	Länge Length
5700/190	19 cm

Zange für Pizzableche

aus Edelstahl 18/10, hochglänzend, zum Greifen heißer Back- und Pizzableche

Pan Gripper

18/10 stainless steel, mirror polished finish



Art-Nr. Part No.	Länge Length
5600/160	15 cm

Zange für Pizzablech

aus Aluminiumguss, mit innenliegender Feder

Pan Gripper

cast aluminium, with internal spring



Art-Nr. Part No.	Länge Length
5674/210	21 cm

Pizzaschaufel

ganz aus Aluminium

Pizza Peel

aluminium



Art-Nr. Part No.	Schaufelmaß Scoop dimension cm	Stiellänge Handle Length cm
4765/270	24 x 17	28

Pizzaschaufel

aus Aluminium, mit Holzstiel

Pizza Peel

aluminium, with wooden handle



Art-Nr. Part No.	Schaufelmaß Scoop dimension cm	Stiellänge Handle Length cm
4765/480	35 x 30,5	43
4765/940	35 x 30,5	94

Pizzaschaufel

rechteckige Form, ganz aus eloxiertem Aluminium, mit rotem abgefachten Stiel, stabile Qualität

Pizza Peel

rectangular, completely made of aluminium, scoop anodized, wide red handle



Art-Nr. Part No.	Schaufelmaß Scoop dimension cm	Stiellänge Handle Length cm
1738/320	32 x 33	120
gelochte Ausführung: / perforated:		
1739/321	32 x 33	120

Pizzaschaufel

rund, ganz aus Edelstahl, seidenmatt poliert, 2 cm Stieldicke

Pizza Peel

round, all stainless steel, satin polished finish, handle Ø 2 cm



Art-Nr. Part No.	∅ Schaufel ∅ Scoop cm	Stiellänge Handle Length cm
1760/200	20	130
1760/300	30	120

Art-Nr. Part No.	Größe Size cm	Länge Length cm
Borsten aus feinem Messingdraht: / with bristles made of fine brass wire:		
1737/174	16,5 x 6	165
Naturborsten aus Palmenfaser: / with natural bristles made of palm fibre:		
1737/175	16,5 x 6	165
1737/901	Ersatzbürste Messingborsten / Spare brush with brass bristles	
1737/902	Ersatzbürste Naturborsten / Spare brush with natural bristles	



Pizzaofenbürste

aus Edelstahl 18/10, Borsten wahlweise aus Palmenfaser oder Messing auf unlackiertem Buchenholz, starre Stange (Ø 1,8 cm) mit zwei lackierten Buchengriffen, davon einer frei beweglich, Schnellwechselvorrichtung für Bürste, nicht spülmaschinengeeignet

Pizza Oven Brush

18/10 stainless steel, choice of brushes with bristles made of palm fibre or brass on unlacquered beechwood, two beech handles, one slides up and down, quick to change brushes, not dishwasher proof



Art-Nr. Part No.	Spatelmaß Blade cm	Länge gesamt Total Length cm
4069/190	19 x 15	32



Pizzaheber, groß

aus Edelstahl 18/0, matt poliert, linke und vordere Kante schräg angeschliffen, mit schwarzem Griff aus Polypropylen, schwere Qualität

Pizza Slice

18/0 stainless steel blade, matt polished finish, sharp left and front edge, with black polypropylene handle, heavy gauge



Art-Nr. Part No.	Ø dia. cm	Stiellänge Handle Length cm
4760/260	25,5	15



Pizzaheber, rund

aus 1,2 mm starkem Edelstahl 18/0, seidenmatt poliert, vorderes Segment angeschliffen, hinteres Segment mit Verstärkungsrand, mit schwarzem Griff aus Polypropylen, schwere Qualität

Pizza Peel

1.2 mm thick 18/0 stainless steel, satin polished finish, black polypropylene handle, sharp front edge, heavy gauge



Art-Nr. Part No.	Länge Length cm	Breite max. Max. Width cm
5683/560	55,5	13



Pizza-Wiegemesser

aus Edelstahl, mit Aufhängeloch

Pizza Cutter

stainless steel, with hanging hole



Art-Nr. Part No.	Länge Length cm	Ø Rad Ø Wheel cm
4061/100	24	10



Pizzaschneider

aus Edelstahl, hochglänzend poliert, mit Griff aus weißem Polypropylen, ergonomisch geformt

Pizza Cutter

stainless steel wheel, mirror polished finish, with white polypropylene handle, ergonomically designed



Art-Nr. Part No.	Länge Length cm	Ø Rad Ø Wheel cm
5675/100	25,5	10



Pizzaschneider

aus Edelstahl, mit Holzgriff und Fingerschutz

Pizza Cutter

stainless steel wheel, with finger guard and wooden handle



Pizzaschneider

ganz aus Edelstahl 18/10, hochglänzend, besonders handlich durch breiten, ergonomischen Hohlgriff, schwere Qualität

Pizza Cutter

18/10 stainless steel, mirror polished finish, ergonomic hollow handle, heavy gauge



Art-Nr. Part No.	Länge Length	Ø Rad Ø Wheel
1730/085	22 cm	8,5 cm
1730/110	24 cm	11 cm

Teigrad

Serie POLARIS, mit seidenmatt poliertem Griff aus Edelstahl 18/10, glattes Rädchen aus matt poliertem Edelstahl 18/0, mit Fingerschutz

Pastry Cutter

with hanging loop, handle 18/10 stainless steel, plain wheel 18/0 stainless steel, with finger guard



Art-Nr. Part No.	Länge Length	Ø Rad Ø Wheel
934/057	18,5 cm	5,7 cm
934/067	19 cm	6,7 cm

Teigrad

Serie POLARIS, mit seidenmatt poliertem Griff aus Edelstahl 18/10, gewelltes Rädchen aus matt poliertem Edelstahl 18/0, mit Fingerschutz

Pastry Cutter

with hanging loop, handle 18/10 stainless steel, fluted wheel 18/0 stainless steel, with finger guard



Art-Nr. Part No.	Länge Length	Ø Rad Ø Wheel
935/057	18,5 cm	5,7 cm

Teigrädchen

Serie POLARIS, mit Griff aus Edelstahl 18/10, schwere Qualität, gewelltes Rädchen aus hochglänzend poliertem Edelstahl 18/0

Pastry Cutter

with 18/10 stainless steel handle and 18/0 stainless steel fluted wheel



Art-Nr. Part No.	Länge Length	Ø Rad Ø Wheel
939/180	18 cm	3,5 cm

Pizzaschere

angewinkelte Form, zerlegbar, spülmaschinengeeignet

Pizza Scissors

can be taken apart, dishwasher safe



Art-Nr. Part No.	Länge Length	Klingenlänge Blade Length
1086/230	23 cm	12 cm

Pizzaballenbehälter

aus weißem HD-Polyethylen, lebensmittelgeeignet, schwere Qualität

Pizza Dough Box

white high density polyethylene, food safe, heavy gauge



Art-Nr. Part No.	Länge außen Outer Length	Breite außen Outer Width	Höhe außen Outer Height
2510/600	60 cm	40 cm	7,5 cm
Deckel separat bestellen: / Please order lid separately:			
2510/601	60 cm	40 cm	2,5 cm

Art-Nr. Part No.	Länge Length cm	Breite Width cm	Höhe Height cm
3102/001	18	19	13



Nudelmaschine

Gehäuse aus Edelstahl 18/0, zur Herstellung von Teigwaren, Walzenbreite 140 mm, Schnittbreiten wahlweise 1,5 und 6 mm, Teigstärke bis 3 mm in 9 Stufen einstellbar

Pasta Machine

18/0 stainless steel frame, 140 mm roller width, cuts pastry in 1.5 or 6 mm widths, pastry thickness adjustable up to 3 mm



Art-Nr. Part No.	Fläche Size cm	Länge Length cm
983/155	6,5 x 6,5	15,5



Ravioliusstecher, quadratisch

Serie POLARIS, mit seidenmatt poliertem Griff aus Edelstahl 18/10, Ausstecher aus hartverchromtem Zinkguss

Square Ravioli Cutter

with hanging loop, handle 18/10 stainless steel, chrome plated zinc alloy



Art-Nr. Part No.	Länge Length cm	∅ dia. cm
986/155	15,5	6



Ravioliusstecher, rund

Serie POLARIS, mit seidenmatt poliertem Griff aus Edelstahl 18/10, Ausstecher aus hartverchromtem Zinkguss

Round Ravioli Cutter

with hanging loop, handle 18/10 stainless steel, chrome plated zinc alloy



Art-Nr. Part No.	∅ dia. cm	Höhe Height cm	Länge Length cm
3105/100	10	2,5	17,5



Ravioliformer

aus Edelstahl 18/10, hochglänzend poliert, zum Formen von Maultaschen und Ravioli

Ravioli Mould

18/10 stainless steel, mirror polished finish



Art-Nr. Part No.	Höhe Height cm
6070/050	15
6070/100	16,5
6070/200	21,5



Ölkanne

aus Edelstahl 18/10, hochglänzend, mit Scharnierdeckel, lebensmittelgeeignet

Oil Can

18/10 stainless steel, mirror polished finish, with hinged lid, food safe





Backformen & Bleche

Mit den **contacto** Backformen können Sie Ihrer Fantasie freien Lauf lassen. Ob Kuchen vom Blech, Gugelhupf oder herzhaften Pasteten, hier werden Sie fündig.

Baking Trays & Sheets

The variety of **contacto**'s bakeware will enable you to come up with exciting, innovative cakes and pastries.

Muffinform

aus 0,38 mm starkem Stahl, PTFE antihaf-beschichtet, nicht spülmaschinengeeignet, 12 Formen Ø 70 x 30 mm

Muffin Tin

steel 0.38 mm thick, with PTFE non-stick coating, not dishwasher proof, 12 moulds 70 mm dia. x 30 mm



Art-Nr. Part No.	Länge Length cm	Breite Width cm
6313/012	35	26,5

Mini-Muffinform

aus 0,38 mm starkem Stahl, PTFE antihaf-beschichtet, nicht spülmaschinengeeignet, 24 Formen Ø 42 x 20 mm

Mini Muffin Tin

steel 0.38 mm thick, with PTFE non-stick coating, not dishwasher proof, 24 moulds 42 mm dia. x 20 mm



Art-Nr. Part No.	Länge Length cm	Breite Width cm
6314/024	38	26

Mini-Donutform

aus 0,4 mm starkem Stahl, PTFE antihaf-beschichtet, nicht spülmaschinengeeignet, 12 Formen Ø 43 x 15 mm

Mini Doughnut Tin

steel 0.4 mm thick, with PTFE non-stick coating, not dishwasher proof, 12 moulds 43 mm dia. x 15 mm



Art-Nr. Part No.	Länge Length cm	Breite Width cm

PRODUKTION
EINGESTELLT
PRODUCTION
DISCONTINUED

Macaronform

aus 0,38 mm starkem Stahl, PTFE antihaf-beschichtet, nicht spülmaschinengeeignet, 35 Formen mit Ø 36 mm

Macaron Tin / Tray

steel 0.38 mm thick, with PTFE non-stick coating, not dishwasher proof, 35 moulds at 36 mm dia.



Art-Nr. Part No.	Länge Length cm	Breite Width cm

PRODUKTION
EINGESTELLT
PRODUCTION
DISCONTINUED



Art-Nr.	∅ innen	Höhe
Part No.	∅ Inside	Height
6301/240	22,5 cm	6,5 cm
6301/260	24,5 cm	6,5 cm
6301/280	26,5 cm	6,5 cm



Springform

aus 0,38 mm starkem Stahl, PTFE antihaft-beschichtet, nicht spülmaschinengeeignet

Springform Tin

steel 0.38 mm thick, with PTFE non-stick coating, not dishwasher safe



Art-Nr.	∅ innen	Höhe
Part No.	∅ Inside	Height
6302/120	11,5 cm	4 cm
6302/160	15 cm	4,5 cm
6302/240	22,5 cm	6,5 cm
6302/260	24,5 cm	6,5 cm
6302/280	26,5 cm	6,5 cm



Springform

aus 0,38 mm starkem Stahl, PTFE antihaft-beschichtet, mit zwei auswechselbaren Böden, einem Flach- und einem Rohrboden, beide tropfsicher, nicht spülmaschinengeeignet

Springform Tin

0.38 mm steel, with PTFE non-stick coating, with two interchangeable bases, one plain and the other with tube, both spill safe, not dishwasher safe



Art-Nr.	∅ innen	Höhe
Part No.	∅ Inside	Height
6303/280	27,5 cm	5,5 cm



Käsekuchenform

aus 0,6 mm starkem Stahl, PTFE antihaft-beschichtet, nicht spülmaschinengeeignet

Flan Tin

steel 0.6 mm thick, with PTFE non-stick coating, not dishwasher safe



Art-Nr.	∅	Höhe
Part No.	dia.	Height
6304/260	26 cm	6,5 cm



Rosettenbackform

aus 0,6 mm starkem Stahl, PTFE antihaft-beschichtet, nicht spülmaschinengeeignet

Swiss Rosette Tin

steel 0.6 mm thick, with PTFE non-stick coating, not dishwasher safe



Art-Nr.	Länge	Breite	Höhe
Part No.	Length	Width	Height
6305/260	26 cm	25 cm	4,5 cm



Herzbackform

aus 0,6 mm starkem Stahl, PTFE antihaft-beschichtet, nicht spülmaschinengeeignet

Heart Tin

steel 0.6 mm thick, with PTFE non-stick coating, not dishwasher safe



Art-Nr.	∅	Höhe
Part No.	dia.	Height
6308/230	23 cm	9 cm



Briocheform

aus 0,6 mm starkem Stahl, PTFE antihaft-beschichtet, nicht spülmaschinengeeignet

Brioche Mould

steel 0.6 mm thick, with PTFE non-stick coating, not dishwasher proof



Rehrückenform

aus 0,8 mm starkem Stahl, PTFE antihaft-beschichtet, mit verstärktem Rand, nicht spülmaschinengeeignet

Ridged Mould

0.8 mm steel, with PTFE non-stick coating, with reinforced edge, not dishwasher safe



Art-Nr. Part No.	Länge Length cm	Breite Width cm	Höhe Height cm	
6366/300	30	11	5	1,2 l

Obsttortenform

aus 0,6 mm starkem Stahl, PTFE antihaft-beschichtet, mit geripptem Rand, nicht spülmaschinengeeignet

Flan Tin

steel 0.6 mm thick, with PTFE non-stick coating, corrugated rim, not dishwasher proof



Art-Nr. Part No.	∅ innen ∅ Inside cm	Höhe Height cm
6306/280	27,5	4

Sandkranzform

aus 0,6 mm starkem Stahl, PTFE antihaft-beschichtet, nicht spülmaschinengeeignet

Ring Mould

steel 0.6 mm thick, with PTFE non-stick coating, not dishwasher proof



Art-Nr. Part No.	∅ dia. cm	Höhe Height cm
6307/250	24	6,5 cm

Bundform/Rodonform

aus 0,6 mm starkem Stahl, PTFE antihaft-beschichtet, nicht spülmaschinengeeignet

Gugelhupf Mould

steel 0.6 mm thick, with PTFE non-stick coating, not dishwasher proof



Art-Nr. Part No.	∅ dia. cm	Höhe Height cm
6309/220	21	11

Antihaft-Backblech

aus 0,6 mm starkem Stahl, PTFE antihaft-beschichtet, nicht spülmaschinengeeignet

Baking Sheet

steel 0.6 mm thick, with PTFE non-stick coating, not dishwasher proof



Art-Nr. Part No.	Länge außen Outer Length cm	Breite außen Outer Width cm	Höhe Height cm
6311/300	39,5	30	2,5
6311/360	39,5	35,5	2,5

Lasagneform

aus 0,6 mm starkem Stahl, PTFE antihaft-beschichtet, mit breiten Rändern als Grifffläche, nicht spülmaschinengeeignet

Lasagne Tin

steel 0.6 mm thick, with PTFE non-stick coating, not dishwasher proof



Art-Nr. Part No.	Länge außen Outer Length cm	Breite außen Outer Width cm	Höhe außen Outer Height cm	
6312/280	32	24,5	5	3 l
6312/320	36	26,5	5	3,5 l



Art-Nr. Part No.	Größe Size cm	Höhe Height cm
Schiffchenform: / Boat mould plain:		
721/030	6,5	1
Briocheform: / Brioche mould:		
721/070	4,5	1,6
Tortelette rund: / Round fluted tartlet:		
721/270	4,8	1,1
Glatte Tortelette rund: / Round plain tartlet:		
721/380	4	1



Petits-Fours

aus Weißblech

Petit Four Moulds

tin



Art-Nr. Part No.	Größe Size cm	Höhe Height cm
6379/050	50 St./10 versch. Formen / 50 pcs./10 diff. shapes	

bestehend aus je 5 Stück Schiffchen (65mm), Marguerite (46mm), Cannelé quadratisch (38mm), Cannelé oval (50mm), Brioche (46mm), Gênois (48mm), Tortelette flach (40mm), Tortelette tief (36mm), Dreieck (45mm), Carré gestreift (40mm)
5 of each: boat (65mm), marguerita (46mm), square cannelé (38mm), brioche (46mm), oval cannelé (50mm), shallow tartlet (40mm), genois (48mm), carré striped (40mm), deep tartlet (36mm), triangles (45mm)



Antihaft-Petits-Fours-Set

aus Stahl, beschichtet mit hochwertiger EXOPAN®-PTFE-Antihftbeschichtung

Non-Stick Petit Four Moulds

steel, with EXOPAN® PTFE non-stick coating, complete set in box



Art-Nr. Part No.	Länge Length cm	Breite Width cm	Höhe Height cm
6372/100	10	4,5	1,2



Antihaft-Schiffchenform

aus Stahl, beschichtet mit hochwertiger EXOPAN®-PTFE-Antihftbeschichtung

Non-Stick Boat Mould

steel, with EXOPAN® PTFE non-stick coating



Art-Nr. Part No.	Ø dia. cm	Höhe Height cm	Ø Boden Ø Base cm
6378/100	10	2	9



Antihaft-Tarteletteform, glatt

ganz aus Exoglass®, mit gebördeltem Rand, spülmaschinenfest

Non-Stick Tartlet Mould, plain

Exoglass®, rolled edge, dishwasher safe



Art-Nr. Part No.	Ø dia. cm	Höhe Height cm
6373/060	6	1
6373/080	8	1,2
6373/100	10	1,8
6373/120	12	2



Antihaft-Tarteletteform

aus Stahl, beschichtet mit hochwertiger EXOPAN®-PTFE-Antihftbeschichtung, großwelliger Rand

Non-Stick Tartlet Mould, fluted

steel, with EXOPAN® PTFE non-stick coating



Antihaft-Tarteletteform

aus Stahl, beschichtet mit hochwertiger EXOPAN®-PTFE-Antihafbeschichtung, engwelliger Rand

Non-Stick Fluted Quiche Mould

steel, with EXOPAN® PTFE non-stick coating, narrow bulges



Art-Nr. Part No.	∅ dia.	Höhe Height
6374/105	10,5 cm	1,8 cm

Antihaft-Tarteletteform

aus 0,6 mm starkem Stahl, PTFE antihaft-beschichtet

Non-Stick Tartlet Mould, fluted

0.6 mm thick steel, with PTFE non-stick coating



Art-Nr. Part No.	∅ dia.	Höhe Height
6316/120	12 cm	2 cm

Preis/Verpackung à 4 Stück
Priced & packed in 4's

Tarteletteform

aus Weißblech, zweiteilig, mit losem Boden zum leichten Ausheben des Backwerks

Tartlet Mould, fluted

tin, with loose base for easy removal



Art-Nr. Part No.	∅ dia.	Höhe Height
738/100	10 cm	3 cm

Briocheform

aus Weißblech

Brioche Mould

tin



Art-Nr. Part No.	∅ dia.	Höhe Height
684/090	8 cm	3,5 cm

Antihaft-Briocheform

aus Stahl, beschichtet mit hochwertiger EXOPAN®-PTFE-Antihafbeschichtung, zehn Wellen

Non-Stick Brioche Mould

steel, with EXOPAN® PTFE non-stick coating



Art-Nr. Part No.	∅ dia.	Höhe Height
6371/080	8 cm	3 cm

Antihaft-Gugelhupf-Form

ganz aus Exoglass® Antihaft-Material, backofen- und spülmaschinenfest

Gugelhupf Moulds

Exoglass® non-stick material, oven and dishwasher safe



Art-Nr. Part No.	∅ dia.	Höhe Height
6370/100	9,5 cm	6,5 cm



Art-Nr. Part No.	Länge Length cm	Breite Width cm
3445/600	60	40



Backrost

aus Edelstahl 18/10, Drahtstärke Ø 2 mm, Rahmendraht Ø 5 mm, extra schwere Qualität

Baking Grid

18/10 stainless steel, wire Ø 2 mm, frame wire Ø 5 mm, extra strong construction



Art-Nr. Part No.	Ø dia. cm	Höhe Height cm
aus Edelstahl: / stainless steel:		
3400/300	30	2
3400/350	32	2
verzinnete Ausführung: / tin plated version:		
3400/370	35	2

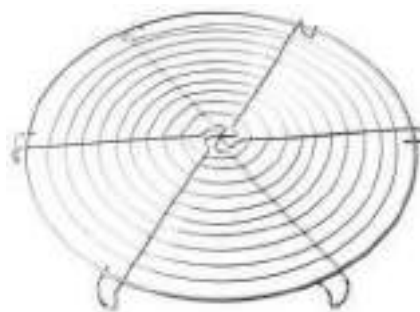

Kuchengitter, rund

Rahmendraht Ø 3 mm, Gitterdraht Ø 1,2 mm, stabile Qualität

Round Cooling Rack

frame: 3 mm thick, wire: Ø 1.2 mm thick



Art-Nr. Part No.	Länge Length cm	Breite Width cm	Höhe Height cm
---------------------	-----------------------	-----------------------	----------------------

PRODUKTION
EINGESTELLT
PRODUCTION
DISCONTINUED



Kuchengitter

ganz aus Edelstahl 18/10, Draht Ø 2 mm, Rahmendraht Ø 4 mm, sauber verschweißt, stabile, hochwertige Qualität

Cooling Rack

18/10 stainless steel, wire Ø 2 mm, frame wire Ø 4 mm, strong construction



Art-Nr. Part No.	Länge Length cm	Breite Width cm	Höhe Height cm
3500/440	44	31	2
3500/470	47	31	2,2
3500/590	59	39	2,6

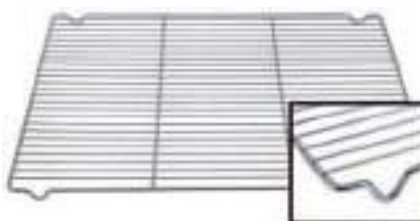

Kuchengitter

aus Edelstahl 18/10, elektropoliert, Drahtstärke 2,5 mm, Rahmendraht 6 mm, extra schwere Qualität, zum Glasieren, Kandieren und Überziehen

Cooling Rack

18/10 stainless steel, electro-polished, frame 6 mm thick, wire 2.5 mm thick, extra heavy gauge



Art-Nr. Part No.	Länge Length cm	Breite Width cm	Höhe Height cm
4718/500	48	32	2,5
4718/600	60	40	2,5



Abtropfschale

für Überzuggitter 3500, aus Aluminium, aus einem Stück gezogen

Rectangular Tray

for cooling rack 3500, aluminium, one piece



Backblech

aus 1,5 mm starkem Aluminiumblech, ungebeizt, aus einem Stück gezogen, Ränder 90° mit geschlossenen Ecken, nicht spülmaschinengeeignet

Baking Sheet

1.5 mm thick aluminium, 90° rim with folded edges and welded corners, not dishwasher proof



Art-Nr. Part No.	Länge außen Outer Length cm	Breite außen Outer Width cm	Höhe Height cm
Gastronorm GN 1/1:			
4722/530	53	32,5	2

Antihaft-Backblech

aus 1,7 mm starkem Aluminium, mit PTFE-Antihaft-Beschichtung, Ränder 45° mit geschlossenen Ecken, nicht spülmaschinengeeignet

Non-Stick Baking Sheet

1.7 mm thick aluminium, with PTFE coating, 45° rim with closed corners, not dishwasher safe



Art-Nr. Part No.	Länge außen Outer Length cm	Breite außen Outer Width cm	Höhe Height cm
Gastronorm GN 1/1:			
6377/530	53	32,5	1
Backofenmaß 60 x 40 cm:			
6377/600	60	40	1

Backblech, Edelstahl

aus 1,1 mm starkem Edelstahl 18/10, aus einem Stück gezogen, Ränder 45° mit geschlossenen Ecken

Baking Sheet

1.1 mm thick 18/10 stainless steel, one piece, 45° rim



Art-Nr. Part No.	Länge außen Outer Length cm	Breite außen Outer Width cm	Höhe Height cm
Backofenmaß 60 x 40 cm:			
7760/600	60	40	0,7

Backblech, perforiert

aus ungebeiztem Aluminiumblech, aus einem Stück gezogen, Ränder 45° mit geschlossenen Ecken, 3 mm Perforierung, ideal für den Einsatz von Backmatten, nicht spülmaschinengeeignet

Baking Sheet, perforated

aluminium, one piece, 45° rim with closed corners, with 3 mm perforations, ideal for use with baking mats, not dishwasher proof



Art-Nr. Part No.	Länge außen Outer Length cm	Breite außen Outer Width cm	Höhe Height cm	Dicke Thickness mm
Gastronorm GN 1/1:				
4725/530	53	32,5	1	1,5
Backofenmaß 60 x 40 cm:				
4725/600	60	40	1	2,0

Art-Nr. Part No.	Länge außen Outer Length cm	Breite außen Outer Width cm	Höhe außen Outer Height cm
Größe: Gastronorm GN 1/1 / Size: Gastronorm GN 1/1			
6323/530	53	32,5	1



Antihaft-Backblech, perforiert

aus 1,5 mm starkem Aluminium, mit Beschichtung aus PTFE, Ränder 45° mit offenen Ecken, 3 mm Perforierung, nicht spülmaschinengeeignet

Non-Stick Baking Sheet, perforated

1.5 mm thick aluminium, PTFE non-stick coating, 45° open rim, with 3 mm perforations, not dishwasher safe



Art-Nr. Part No.	Länge Length cm	Breite außen Outer Width cm	Höhe außen Outer Height cm
Größe: Gastronorm GN 1/1 / Size: Gastronorm GN 1/1			
6324/530	53	32,5	1



Antihaft-Backblech, perforiert

aus 1,5 mm starkem Aluminium, mit roter Beschichtung aus Silikon, Ränder 45° mit offenen Ecken, 3 mm Perforierung, nicht spülmaschinengeeignet

Non-Stick Baking Sheet, perforated

1.5 mm aluminium, red silicone non-stick coated, 45° rim with open corners, 3 mm perforation, not dishwasher safe



Art-Nr. Part No.	Länge außen Outer Length cm	Breite außen Outer Width cm	Höhe Height cm
6311/300	39,5	30	2,5
6311/360	39,5	35,5	2,5



Antihaft-Backblech

aus 0,6 mm starkem Stahl, PTFE antihaft-beschichtet, nicht spülmaschinengeeignet

Baking Sheet

steel 0.6 mm thick, with PTFE non-stick coating, not dishwasher proof



Art-Nr. Part No.	Länge außen Outer Length cm	Breite außen Outer Width cm	Höhe Height cm
4718/300	30	20	2
4718/400	40	25	2
4718/500	48,5	32,5	2
4718/600	60	40	2



Backwaren-Ausstellblech

aus 0,9 mm starkem Aluminium, gebeizt, aus einem Stück gezogen, Ränder 90° mit geschlossenen Ecken, nicht spülmaschinengeeignet

Baking Sheet

0.9 mm aluminium, one piece, with folded edge, 90° rims with closed corners, not dishwasher proof



Art-Nr. Part No.	Länge Length cm	Breite Width cm	Höhe Height cm
4730/105	58	10	5
4730/205	58	20	5
4730/405	58	40	5



Schnittkuchenblech

aus Aluminium, einschließlich Vorsatzschiene, nicht spülmaschinengeeignet

Cake tray

aluminium, including removable end, for cake slices not dishwasher safe





Silikon-Backformen

Hier bleibt nichts haften! Silikonbackmatten lassen die Hitze rundum an das Gebäck und geben es rückstandslos frei. Eine Vielzahl von Formen steht für Ihr Backerlebnis bereit.

Silicone Moulds

Nothing sticks here! Bakers and patissiers can be confident of perfect results with these quick release, easy clean silicone moulds in a huge variety of shapes.

Das terrakottafarbene Silikon ist formstabil, geschmacks- und geruchsneutral. Es ist extrem strapazierfähig und langlebig.

Durch die gute Antihafteigenschaft von Silikon lassen sich alle Backwaren ohne vorheriges Einfetten herauslösen.

Zur Reinigung genügt in der Regel ein Ausspülen mit warmen Wasser.

Backmattengröße 37x17,5 cm

These terracotta coloured moulds are ideal for preparing sweets, savouries, chocolate and terrines. The high conductivity of the pure food-specific silicone guarantees soft perfectly browned results and its natural flexibility and non-stick properties ensure quick easy turning out without having to wait and without waste. They can be washed very simply with a jet of warm water using a sponge, or in the dishwasher. Unless otherwise specified moulds measure 30x17.5cm



- reines Silikon
- langlebig
- spülmaschinengeeignet
- absolut hygienisch
- Antihafteigenschaft
- geeignet -60° bis +230°C

- pure silicone
- durable
- dishwasher safe
- completely hygienic
- non-stick
- suitable for -60° to +230°C

Silikon-Briocheform

Non-Stick Brioche Mould



Art-Nr. Part No.	Ø dia. cm	Höhe Height cm
---------------------	-----------------	----------------------

PRODUKTION
EINGESTELLT
PRODUCTION
DISCONTINUED

Silikon-Gugelhupfform

Non-Stick Gugelhupf Mould



Art-Nr. Part No.	Ø dia. cm	Höhe Height cm
6673/220	22	11

Silikon-Kuchenform, rund

Non-Stick Flan Mould



Art-Nr. Part No.	Ø dia. cm	Höhe Height cm
6671/260	26	4,5
6671/280	28	4,7

Art-Nr. Part No.	Länge Length cm	Breite Width cm	Höhe Height cm
6672/260	26	10	7



Silikon-Kastenform

Non-Stick Loaf Mould

Art-Nr. Part No.	∅ dia. cm	Höhe Height cm
6 Formen / 6 moulds 6634/076	6,9	3,5



Silikon-Backmatte, MUFFIN

Non-Stick Muffin Moulds

Art-Nr. Part No.	∅ dia. cm	Höhe Height cm
6 Formen / 6 moulds 6640/076	7	3,5



Silikon-Backmatte, GUGELHUPF

Non-Stick Gugelhupf Moulds

Art-Nr. Part No.	∅ dia. cm	Höhe Height cm
18 Formen / 18 moulds 6652/042	4,1	2,3
6 Formen / 6 moulds 6652/075	7,4	3,8



Silikon-Backmatte, GUGELHUPF

Non-Stick Gugelhupf Moulds

Art-Nr. Part No.	∅ dia. cm	Höhe Height cm
6 Formen / 6 moulds 6631/726	7,2	2,3



Silikon Backmatte, SAVARIN

Non-Stick Savarin Moulds

Art-Nr. Part No.	∅ dia. cm	Höhe Height cm
8 Formen / 8 moulds 6632/068	6	1,7



Silikon-Backmatte, TARTELETTE

Non-Stick Tartlet Moulds

Silikon-Backmatte, DARIOL

Non-Stick Dariol Moulds



Art-Nr. Part No.	∅ dia. cm	Höhe Height cm
8 Formen / 8 moulds 6633/538	5,5	6
15 Formen / 15 moulds 6633/315	3,5	3,8

Silikon-Backmatte, KEGEL

Non-Stick Dariol Moulds



Art-Nr. Part No.	∅ dia. cm	Höhe Height cm
24 Formen / 24 moulds 6651/034	3,4	2,8
8 Formen / 8 moulds 6651/055	5,5	5

Silikon-Backmatte, ZYLINDER

Non-Stick Ramekin Moulds



Art-Nr. Part No.	∅ dia. cm	Höhe Height cm
8 Formen / 8 moulds 6636/068	6	3,5

Silikon-Backmatte, MINI-ZYLINDER

Non-Stick Ramekin Moulds



Art-Nr. Part No.	∅ dia. cm	Höhe Height cm
15 Formen / 15 moulds 6635/415	4	2

Silikon-Backmatte, WÜRFEL

zur Herstellung von Dominosteinen

Non-Stick Cube Moulds



Art-Nr. Part No.	Fläche Size cm	Höhe Height cm
15 Formen / 15 moulds 6644/035	3,5 x 3,5	3,5
8 Formen / 8 moulds 6644/050	5 x 5	5

Silikon-Backmatte, BARREN

Non-Stick Bar Moulds



Art-Nr. Part No.	Länge Length cm	Breite Width cm	Höhe Height cm
9 Formen / 9 moulds 6645/085	8,5	3,5	3

Art-Nr. Part No.	Länge Length cm	Breite Width cm	Höhe Height cm
20 Formen / 20 moulds			
6647/049	4,9	2,6	1,1



Silikon-Backmatte, FLACHBARREN
Non-Stick Financier Moulds

Art-Nr. Part No.	Länge Length cm	Breite Width cm	Höhe Height cm
12 Formen / 12 moulds			
6649/072	7,2	3	1,5
9 Formen / 9 moulds			
6649/100	10	4,4	1,5



Silikon-Backmatte, SCHIFFCHEN
Non-Stick Boat Moulds

Art-Nr. Part No.	Länge Length cm	Breite Width cm	Höhe Height cm
16 Formen / 16 moulds			
6650/065	6,5	3,5	1,7



Silikon-Backmatte, RAUTE
Non-Stick Diamond Moulds

Art-Nr. Part No.	Maß Size cm	Höhe Height cm
9 Formen / 9 moulds		
6637/069	6,8 x 4,5	1,7
15 Formen / 15 moulds		
6637/415	4,4 x 3,4	1



Silikon-Backmatte, MADELEINE
Non-Stick Madeleine Moulds

Art-Nr. Part No.	∅ dia. cm	Höhe Height cm
6 Formen / 6 moulds		
6638/863	8	3
6 Formen / 6 moulds		
6638/864	7,5	4



Silikon-Backmatte, BRIOCHETTE
Non-Stick Briochette Moulds

Art-Nr. Part No.	∅ dia. cm	Höhe Height cm
8 Formen / 8 moulds		
6639/058	5,5	5
18 Formen / 18 moulds		
6639/318	3,5	3,5



Silikon-Backmatte, BORDELAIS
Non-Stick Bordelaise Moulds

Art-Nr. Part No.	∅ dia. cm	Höhe Height cm
3 Formen / 3 moulds		
6641/100	10	2



Silikon-Backmatte, BISKUIT
Non-Stick Biscuit Moulds

Silikon-Backmatte, AMARETTI

Non-Stick Amaretti Moulds



Art-Nr. Part No.	∅ dia. cm	Höhe Height cm
24 Formen / 24 moulds 6643/034	3,4	1,6

Silikon-Backmatte, WENDELTURM

Non-Stick Spiral Tower Moulds



Art-Nr. Part No.	∅ dia. cm	Höhe Height cm
6 Formen / 6 moulds 6642/068	6,8	5

Silikon-Backmatte, HALBKUGEL

Non-Stick Hemispherical Moulds



Art-Nr. Part No.	∅ dia. cm	Höhe Height cm
5 Formen / 5 moulds 6630/085	8	4
6 Formen / 6 moulds 6630/076	7	3,5
15 Formen / 15 moulds 6630/415	4	2

Silikon-Backmatte, HALBES EI

Non-Stick Egg Moulds



Art-Nr. Part No.	Größe Size cm	Höhe Height cm
mit 5 Formen / with 5 moulds 6646/100	10 x 7	3,5

Silikon-Backmatte, HERZ

Non-Stick Heart Moulds



Art-Nr. Part No.	∅ dia. cm	Höhe Height cm
8 Formen / 8 moulds 6648/060	6	3,5

Silikon-Backmatte, MACARONS

auch zur Herstellung von Whoopies

Non-Stick Macarons Moulds
for making whoopies



Art-Nr. Part No.	∅ dia. mm	Höhe Height mm
mit 20 Formen / 20 moulds 6679/065	25 - 40 - 65	9

Art-Nr.	∅
Part No.	dia.
15 Formen / 15 moulds	
853/037	3,7 cm

Mattengröße 22 x 14 cm.
Mat size: 22 x 14 cm.



Backform für Cake-Pops

mit Ober- und Unterschale, aus reinem Silikon, terrakottafarben, spülmaschinengeeignet, geruchs- und geschmacksneutral, temperaturbeständig von -60°C bis +230°C, formstabil

Cake Pop Mould

two piece, silicone, suitable for -60°C to +230°C, non-stick, dishwasher safe



Art-Nr.	Länge
Part No.	Length
aus Holz: / wooden:	
854/110	11 cm
aus Pappe: / card:	
854/240	12 cm

Preis und Verpackung für einen Beutel à 50 Stück.
Priced and packed in 50's



Stiel für Cake-Pops

aus Holz

Cake Pop Sticks

wooden



Art-Nr.	Länge	Breite
Part No.	Length	Width
Für Backbleche GN 1/1: / For GN 1/1 Baking Sheets:		
6390/520	52 cm	31,5 cm

Für Backbleche 60x40cm: / For 60x40cm Baking Sheets:		
6390/585	58,5 cm	38,5 cm
6390/400	40 cm	30 cm

Für Backbleche GN 2/1: / For GN 2/1 Baking Sheets GN 2/1:		
6390/640	64 cm	52 cm

Wir empfehlen, die Backmatten auf perforierten Backblechen (Seite 228) oder Backrosten (Seiten 227 und 42) einzusetzen. Nicht falten und nicht auf den Matten schneiden.
We recommend using these mats on perforated baking sheets (see page 227, 42 or 228). Do not fold the mats or cut on them.



Antihaft-Backmatte

aus glasfaserverstärkten Silikon, temperaturresistent von -40°C bis +300°C, problemlos mit weichem Schwamm unter heißem Wasser zu reinigen, ersetzt das Backpapier

Non-Stick Baking Mat

fibreglass reinforced silicone temperature resistant from -40°C up to +300 °C, replaces baking paper, easy to clean



Art-Nr.	Größe	Anzahl Formen
Part No.	Size	Moulds
	cm	
6696/155	15,5 x 4,1 x 2,5	18



Silikon-Backmatte Hot Dog

aus schwarzem glasfaserverstärkten Silikon, temperaturresistent von -40°C bis +280°C, für 60 x 40 cm Backbleche

Hot Dog Baking Mat

fibreglass reinforced black silicone, withstands temperatures from -40°C to +280°C, for 60 x 40 cm baking sheets



Art-Nr.	Länge	Breite
Part No.	Length	Width
	cm	cm
	GN	

PRODUKTION
EINGESTELLT
PRODUCTION
DISCONTINUED



Silikon-Backmatte Brötchen/ Baguette

aus schwarzem glasfaserverstärkten Silikon, -40°C bis +280°C, zum Aufbacken von tiefgefrorenen Brötchen- oder Baguetteteigen

Baguette Baking Mat

fibreglass reinforced black silicone, -40°C to +280°C, ideal for baking raw frozen dough



Silikon-Backmatte Gewölbte Klößchen

aus schwarzem glasfaserverstärkten Silikon,
temperaturresistent von -40°C bis +280°C

GN 1/2 Flexipan® Mat Quenelle Moulds

fibreglass reinforced black silicone,
withstands temperatures -40°C to +280°C



Art-Nr. Part No.	Größe Size cm	GN	Anzahl Formen Moulds
6681/060	6 x 4 x 2,5	1/2	15

Silikon-Backmatte Klößchen

aus schwarzem glasfaserverstärkten Silikon,
temperaturresistent von -40°C bis +280°C

GN 1/1 Flexipan® Quenelle Moulds

fibreglass reinforced black silicone,
withstands temperatures from -40°C to +280°C



Art-Nr. Part No.	Größe Size cm	GN	Anzahl Formen Moulds
6681/067	6,5 x 3,5 x 3	1/1	43
6681/084	8 x 4,5 x 3,5	1/1	32

Silikon-Backmatte Halbkugel

aus schwarzem glasfaserverstärkten Silikon, temperatur-
resistent von -40°C bis +280°C

GN 1/2 Flexipan® Hemispherical Moulds

fibreglass reinforced black silicone,
withstands temperatures from -40°C to +280°C



Art-Nr. Part No.	Ø dia. cm	GN	Anzahl Formen Moulds
6685/042	4,2	1/2	20
6685/058	5,8	1/2	12
6685/070	7	1/2	9

Silikon-Backmatte Pomponette

aus schwarzem glasfaserverstärkten Silikon,
temperaturresistent von -40°C bis +280°C

GN 1/2 Flexipan® Pomponette Moulds

fibreglass reinforced black silicone,
withstands temperatures from -40°C to +280°C



Art-Nr. Part No.	Ø dia. cm	GN	Anzahl Formen Moulds
6686/036	3,6	1/2	30

Art-Nr. Part No.	∅ dia. cm	Höhe Height cm	GN	Anzahl Formen Moulds
---------------------	-----------------	----------------------	----	-------------------------

PRODUKTION
EINGESTELLT
PRODUCTION
DISCONTINUED



Silikon-Backmatte Florentiner
aus schwarzem glasfaserverstärkten Silikon,
temperaturresistent von -40°C bis +280°C

GN 1/2 Flexipan® Florentine Moulds
fibreglass reinforced black,
withstands temperatures from -40°C to +280°C



Art-Nr. Part No.	Größe Size cm	GN	Anzahl Formen Moulds
6688/035	3,5 x 3,5 x 2,5	1/2	30
6688/050	5 x 5 x 3,5	1/2	12
6688/071	7,1 x 7,1 x 4,5	1/2	9

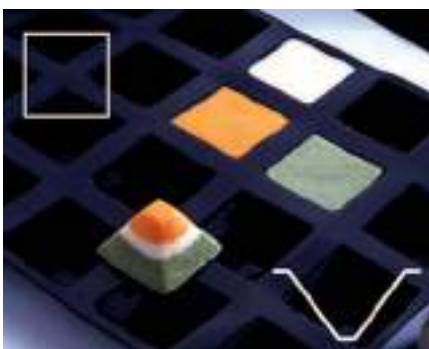

Silikon-Backmatte Pyramide
aus schwarzem glasfaserverstärkten Silikon,
temperaturresistent von -40°C bis +280°C

GN 1/2 Flexipan® Pyramid Moulds
fibreglass reinforced black,
withstands temperatures from -40°C to +280°C



Art-Nr. Part No.	Größe Size cm	GN	Anzahl Formen Moulds
6689/080	8 x 6 x 2,5	1/2	6



Silikon-Backmatte Ovale Savarins
aus schwarzem glasfaserverstärkten Silikon,
temperaturresistent von -40°C bis +280°C

GN 1/2 Flexipan® Oval Savarin Moulds
fibreglass reinforced black,
withstands temperatures from -40°C to +280°C



Art-Nr. Part No.	∅ dia. cm	Höhe Height cm	Anzahl Formen Moulds
6690/051	5,1	3	40



Silikon-Backmatte Mini-Muffins
aus schwarzem glasfaserverstärkten Silikon,
temperaturresistent von -40°C bis +280°C,
für 60 x 40 cm Backbleche

Flexipan® Mini Muffin Moulds
fibreglass reinforced black, withstands temperatures
from -40°C to +280°C, for 60 x 40 cm baking sheets



Art-Nr. Part No.	Größe Size cm	Anzahl Formen Moulds
6691/056	5,6 x 5,6 x 2,5	35
6691/070	7 x 7 x 3	24



Silikon-Backmatte Quadratische Savarins

aus schwarzem glasfaserverstärkten Silikon,
temperaturresistent von -40°C bis +280°C,
für 60 x 40 cm Backbleche

Flexipan® Square Savarin Moulds
fibreglass reinforced black, withstands temperatures
from -40°C to +280°C, for 60 x 40 cm baking sheets



Backformen

Bringen Sie Ihre Ideen in Form. Erschaffen Sie außergewöhnliche Kompositionen mit Pyramiden, Halbkugeln, Ringen, Zylindern und Dreiecken.

Rings & Moulds

From pudding basins and darioles to rings and terrines, you can produce extraordinary creations.



Quiche-/ Tortenbodenform

aus Weißblech, zweiteilig, mit loseem Boden zum leichten Ausheben des Backwerks

Quiche Tin

fluted, tin, with loose base for easy removal



Art-Nr. Part No.	∅ dia.	Höhe Height
735/200	20 cm	2,5 cm
735/240	24 cm	2,5 cm
735/260	26 cm	2,5 cm
735/280	28 cm	2,5 cm
735/300	30 cm	2,5 cm
735/320	32 cm	2,5 cm

Quiche- /Tortenbodenform

aus PTFE antihaft-beschichtetem Stahlblech, zweiteilig, mit loseem Boden zum leichten Ausheben des Backwerks

Quiche Tin, fluted

non-stick coated steel, with loose base for easy removal



Art-Nr. Part No.	∅ dia.	Höhe Height
736/240	24 cm	2,5 cm
736/280	28 cm	2,5 cm
736/320	32 cm	2,5 cm

Terrinenform, klein

Dachrinnenform, aus Edelstahl 18/10, hochglänzend poliert

Mini Terrine/Aspic Mould

18/10 stainless steel, mirror polished finish



Art-Nr. Part No.	Länge Length cm	Breite Width cm	Höhe Height cm	
680/135	13,5	4	4,5	0,16 l

Terrinenform

Dachrinnenform, aus Edelstahl 18/10, hochglanzpoliert, schwere Qualität

Terrine (Gutter)/ Yule Log Mould

18/10 stainless steel, mirror polished finish, heavy gauge



Art-Nr. Part No.	Länge Length cm	Breite Width cm	Höhe Height cm	
712/350	35	6	4,7	0,9 l
712/500	50	8	6,6	2 l
713/500	50	6,2	4,5	1,4 l

Terrinenform

aus Edelstahl 18/0, hochglänzend, halbrunde Form, mit Deckel

Terrine/Yule Log Mould

18/0 stainless steel, mirror polished finish, with lid



Art-Nr. Part No.	Länge Length cm	Breite Width cm	Höhe Height cm	
861/180	18	7,5	7	0,8 l
861/230	23	7,5	7	1 l
861/280	28	7,5	7	1,25 l
861/380	38	7,5	7	1,75 l

Pastetenformen

Terrine Moulds



contacto

Art-Nr. Part No.	Länge Length cm	Breite Width cm	Höhe Height cm	
Dreieck spitz: / triangular				
885/501	50	10	9	2 l
Halbrund ("Dachrinne"): / half round				
885/502	50	10	9	3,5 l



Pastetenform

aus Edelstahl 18/10, hochglänzend,
Bodenabstand ca. 0,5 cm, mit Deckel

Terrine Mould

18/10 stainless steel, mirror polished finish, with lid



Art-Nr. Part No.	Länge Length cm	Breite Width cm	Höhe Height cm	
Dreieck spitz: / Triangular				
882/261	26	8	7,5	0,7 l
Halbrund ("Dachrinne"): / half round				
882/262	26	8,5	7,5	1 l
klassisch: / classic shape				
882/263	26	8,5	7,5	0,7 l



Pastetenform

aus Edelstahl, hochglänzend,
Bodenabstand ca. 1 cm, mit Deckel

Terrine Mould

stainless steel, mirror polished finish, with lid



Art-Nr. Part No.	Länge Length cm	Breite Width cm	Höhe Height cm	
Halbrund (Dachrinne): / half round				
887/272	27,5	5,5	5	0,5 l



Pastetenform

aus Edelstahl, hochglänzend,
Bodenabstand ca. 1 cm, mit Deckel

Terrine Mould

stainless steel, mirror polished finish, with lid



Art-Nr. Part No.	Länge Length cm	Breite max. Max. Width cm	Breite min. Min. Width cm	Höhe Height cm
883/300	30	8	7	7



Pastetenform

aus Edelstahl, hochglänzend, gerade Kastenform,
mit Deckel

Terrine Mould

stainless steel, mirror polished finish, with lid



Antihaft-Pastetenform, geriffelt

aus Stahl, beschichtet mit hochwertiger EXOPAN®-PTFE-Antihafbeschichtung, aufklappbar um Beschädigungen an der Pastetenkruste zu vermeiden, mit verstärktem Rand

Non-Stick Pâté Mould (ridged)

steel with EXOPAN® PTFE non-stick coating, with drop down sides for easy removal, with reinforced edge



Art-Nr. Part No.	Länge Length cm	Breite Width cm	Höhe Height cm	
6362/300	30	7	8	1,5 l

Antihaft-Pastetenform, glatt

aus Stahl, beschichtet mit hochwertiger EXOPAN®-PTFE-Antihafbeschichtung, aufklappbar um Beschädigungen an der Pastetenkruste zu vermeiden, mit verstärktem Rand

Non-Stick Pâté Mould, plain

steel with EXOPAN® PTFE non-stick coating, with drop down sides for easy removal, with reinforced edge



Art-Nr. Part No.	Länge Length cm	Breite Width cm	Höhe Height cm	
6361/300	30	7	8	1,5 l

Antihaft-Pastetenform, oval

aus Stahl, beschichtet mit hochwertiger EXOPAN®-PTFE-Antihafbeschichtung, aufklappbar um Beschädigungen an der Pastetenkruste zu vermeiden

Non-Stick Oval Pâté Mould

steel with EXOPAN® PTFE non-stick coating, side open for easy removal



Art-Nr. Part No.	Länge innen Inner Length cm	Breite innen Inner Width cm	Höhe Height cm	
6360/210	21	13	9	1,5 l

Antihaft-Kastenform, glatt

aus Stahl, beschichtet mit hochwertiger EXOPAN®-PTFE-Antihafbeschichtung, mit verstärktem Rand, nicht zerlegbar, konische Wände

Non-Stick Loaf Tin

steel with EXOPAN® PTFE non-stick coating, with reinforced edge



Art-Nr. Part No.	Länge innen Inner Length cm	Breite innen Inner Width cm	Höhe außen Outer Height cm	
6363/300	30	8	8	1,5 l

Antihaft-Pastetenform, glatt

aus Stahl, beschichtet mit PTFE-Antihafbeschichtung, nicht aufklappbar, mit verstärktem Rand

Non-Stick Loaf Tin

steel with PTFE non-stick coating, with reinforced edge



Art-Nr. Part No.	Länge Length cm	Breite Width cm	Höhe Height cm	
6368/150	14,5	8	5	0,5 l
6368/240	24,5	10,5	7	1,5 l



Art-Nr. Part No.	Länge innen Inner Length cm	Breite innen Inner Width cm	Höhe innen Inner Height cm	
2828/280	28	9	8	1,5 l



Terrinenform

aus Gusseisen, weiß emailliert

Terrine/Pâté Mould
cast iron, white enamelled



Art-Nr. Part No.	Länge innen Inner Length cm	Breite innen Inner Width cm	Höhe Height cm	
5110/250	25	10	6,5	1 l
5110/300	30	11,5	6,5	2 l
5110/350	35	12	8	3 l



Backform

aus Edelstahl 18/10, hochglänzend poliert, mit schmalen glatten Rand, schwere Qualität, insbesondere für die Herstellung von Sauerteig geeignet

Loaf Tin

18/10 stainless steel, mirror polished finish, with narrow, flat edge, heavy gauge



Art-Nr. Part No.	Länge innen Inner Length cm	Breite innen Inner Width cm	Höhe außen Outer Height cm	
6310/250	25	11	6,5	1,5 l
6310/300	30	11	6,5	2 l



Backform

aus 0,6 mm starkem Stahl, PTFE antihaft-beschichtet, nicht spülmaschinengeeignet

Loaf Tin

steel 0.6 mm thick, with PTFE non-stick coating, not dishwasher proof



Art-Nr. Part No.	Länge innen Inner Length cm	Breite innen Inner Width cm	Höhe Height cm	
5408/300	30	13,5	9	3 l
5408/350	35	14	9	3,7 l



Leberkäseform

aus Edelstahl 18/10, unpoliert, mit schmalen glatten Rand

Loaf Tin

18/10 stainless steel, unpolished, with narrow, flat edge



Art-Nr. Part No.	Länge Length cm	Breite Width cm	Höhe Height cm	
5430/150	15	10	3	0,25 l



Sülzkotelettform

aus Edelstahl 18/10, mit glatt auslaufendem Rand, schwere Qualität

Aspic Cutlet Mould

18/10 stainless steel, heavy gauge



Art-Nr. Part No.	Länge innen Inner Length cm	Breite innen Inner Width cm	Höhe innen Inner Height cm	
für 0,5 kg Stangenbrot: / for 0.5 kg baguette:				
4859/450	42,5	8,5	5,5	
für 0,5 kg rundes Brot: / for 0.5 kg round bread:				
4857/200	18,5		7	
für 1 kg rundes Brot: / for 1 kg round bread:				
4857/220	20,5		7,5	
für 0.5 kg ovales Brot: / for 0.5 kg oval bread:				
4858/300	28	12	5,5	



Gärschale

aus natürlichem Peddigrohr, atmungsaktiv, biologisch abbaubar, lebensmittelecht, ideal geeignet zum Gären des Teigs ohne Gärschrank, nicht zum Backen geeignet

Banneton

from natural rattan, natural respiration, bio-degradable, food safe, for naturally allowing dough to prove in the shape of the basket before its final bake, not suitable for use in ovens



Pyramidenform

aus Edelstahl, außen hochglänzend

Pyramid Mould

stainless steel, mirror polished finish outside



Art-Nr. Part No.	Fläche Size cm	Höhe Height cm	
875/040	4 x 4	4	0,025 l
875/050	5 x 5	4,2	0,03 l
875/060	6 x 6	4,5	0,05 l
875/085	8,5 x 8,5	8	0,15 l
875/120	12 x 12	12	0,4 l

Halbkugelschale

aus Edelstahl 18/10, hochglänzend poliert, schwere Qualität

Hemispherical Mould

18/10 stainless steel, mirror polished finish, heavy gauge



Art-Nr. Part No.	∅ dia. cm	Höhe Height cm	
877/030	2,5	1,5	0,01 l
877/045	4,5	2,3	0,02 l
877/050	5	2,5	0,03 l
877/060	6	3	0,06 l
877/070	7	3,5	0,08 l
877/080	8	4	0,125 l
877/090	9	4,5	0,2 l
877/100	10	5	0,25 l
877/110	11	5,5	0,375 l
877/120	12	6	0,5 l
877/140	14	7	0,75 l
877/160	16	8	1 l
877/180	18	9	1,5 l
877/200	20	10	2 l
877/250	25	13	4 l

Halterung für Pyramiden- und Halbkugelformen

aus Edelstahl, hochglänzend, vier Löcher mit 3 cm und drei Löcher mit 5 cm Durchmesser, beidseitig nutzbar

Stand for Pyramid and Hemispherical Moulds

stainless steel, mirror polished finish, with 4 holes (3 cm ∅) and 3 holes (5 cm ∅), can be used upside down



Art-Nr. Part No.	Länge Length cm	Breite Width cm	Höhe Height cm
878/500	50	7	7

Geeignet für Halbkugelschalen von 4,5 bis 12 cm oder Pyramidenformen von 8,5 bis 12 cm.

Lieferung ohne Pyramiden- und Halbkugelformen. Bitte separat bestellen.

Suitable for hemispherical bowls from 4.5 to 12 cm or pyramids from 8.5 to 12 cm.

Please order moulds separately.

Puddingform

ohne Innenrohr, aus Edelstahl 18/10, außen hochglänzend poliert, mit Deckel, schwere Qualität

Gugelhupf Mould

without inside tube, 18/10 stainless steel, mirror polished finish outside, with lid, heavy gauge



Art-Nr. Part No.	∅ oben ∅ Top cm	Höhe gesamt Overall Height cm	
871/140	14	13,5	1,2 l
871/160	16	14	1,5 l
871/180	18	15,5	2,4 l

Puddingform

mit Innenrohr, aus Edelstahl 18/10, außen hochglänzend poliert, mit Deckel, schwere Qualität

Gugelhupf Mould

with inside tube, 18/10 stainless steel, mirror polished finish outside, with lid, heavy gauge



Art-Nr. Part No.	∅ oben ∅ Top cm	Höhe gesamt Overall Height cm	
872/140	14	13,5	1 l
872/160	16	14	1,2 l
872/180	18	15,5	2 l

Spezialformen

Pyramid & Hemispherical Moulds



contacto

Art-Nr. Part No.	∅ außen ∅ Outside cm	Höhe Height cm	Füllbreite Width cm
727/080	8,5	2	2



Savarinförmchen

aus Weißblech, innen geschlossen, mit gebördeltem Rand

Savarin Mould

tin, closed centre, rolled edge



Art-Nr. Part No.	∅ außen ∅ Outside cm	Höhe Height cm	Füllbreite Width cm
6376/080	8,5	2	2,5



Antihaft-Savarinförmchen

aus Stahl, beschichtet mit hochwertiger EXOPAN®-PTFE-Antihftbeschichtung, mit gebördeltem Rand, innen geschlossen

Non-Stick Savarin Mould

steel with EXOPAN® PTFE non-stick coating, rolled edge, closed



Art-Nr. Part No.	Höhe Height cm	∅ innen ∅ Inside cm	∅ Loch ∅ Hole cm	Füllbreite Width cm
606/080*	2,5	8	2	2,5
606/120	3,5	11	5,5	2,5
606/150	3,5	14	6,5	3
606/160	4	15	8	3
606/190	4,5	18	10	4
606/220	5	21	11	4,5

* Innenrand leicht erhöht

* Inner rim higher



Reisrand / Savarinform

aus Edelstahl 18/10, hochglänzend, schwere Qualität

Savarin Mould

18/10 stainless steel, mirror polished, heavy gauge



Art-Nr. Part No.	Portionsgröße Portion size l	∅ dia. cm	Höhe Height cm
876/080	0,125 l	8	4,5
876/100	0,25 l	10	7
876/120	0,5 l	12	8
876/140	0,75 l	14	9
876/160	1 l	16	9,5
876/180	1,5 l	18	11
876/200	2 l	20	12

Höhenangabe mit Fuß und Deckel

Height includes foot and lid.



Eisbombenform

aus Edelstahl 18/10, hochglänzend poliert, mit Deckel

Ice Cream Bomb Mould

18/10 stainless steel, mirror polished, with lid



Art-Nr. Part No.	Länge Length cm	Breite Width cm	Höhe Height cm
874/100	28,5	9,5	4,5
874/150	33,5	11,5	4,5
874/200	34	14	4,5



Ziegeleisform

aus Edelstahl 18/10, seidenmatt gebürstet, mit sauber verschweißten Nähten, Deckel und Boden abnehmbar, schwere Qualität

Ice Cream Brick Mould

18/10 stainless steel, satin brushed finish, with welded edges, removable lid and base, heavy gauge



Art-Nr. Part No.	Portionsgröße Portion size l	∅ max. cm	Höhe Height cm
873/050	0,5 l	9,5	8,5
873/100	1 l	12,5	10



Cassata-Eisform

mit Deckel, aus Edelstahl 18/10, hochglänzend, schwere Qualität

Cassata Mould

with lid, 18/10 stainless steel, mirror polished, heavy gauge



Tortenrahmen, rechteckig

aus Edelstahl, stufenlos verstellbar in Länge und Breite, ein entnehmbares Zwischenblech kann als Teiler genutzt werden.

Dessert Frame

stainless steel, adjustable both in width and length, with removable separator bar



Art-Nr. Part No.	Länge Length cm	Breite Width cm	Höhe Height cm
699/050	27,5 - 52,5	18,5 - 34	5

Tortenring

aus Edelstahl 18/0, hochglänzend, mit Griffen stufenlos verstellbar, spülmaschinengeeignet, zum Reinigen ganz zu öffnen, schwere Qualität

Adjustable Mousse Ring

18/0 stainless steel, mirror polished finish, dishwasher proof, adjustable



Art-Nr. Part No.	∅ min. cm	∅ max. cm	Höhe Height cm
690/060	16,5	30	6
690/085	16,5	30	8,5

Tortenring

aus 2 mm starkem Aluminium

Cake Ring

2 mm aluminium



Art-Nr. Part No.	∅ dia. cm	Höhe Height cm
688/260	26	5
688/280	28	5

Tortenring

aus Edelstahl, hochglänzend, mit glatt auslaufendem Rand

Mousse Ring

stainless steel, mirror polished, open edge



Art-Nr. Part No.	∅ dia.	Höhe Height
694/120	12 cm	6 cm
694/140	14 cm	6 cm
694/180	18 cm	6 cm
694/200	20 cm	6 cm

Tortenbodenring, flach

aus Edelstahl 18/0, hochglänzend, mit gebördeltem Verstärkungsrand, für Flan, Tartes, Gebäck und Tortenböden

Flan/ Tart Ring

18/0 stainless steel, mirror polished, rolled edge



Art-Nr. Part No.	∅ dia. cm	Höhe Height cm
692/080	8 cm	2 cm
692/100	10 cm	2 cm
692/160	16 cm	2 cm
692/200	20 cm	2 cm
692/220	22 cm	2 cm
692/240	24 cm	2 cm
692/260	26 cm	2 cm
692/280	28 cm	2 cm
692/300	30 cm	2 cm
692/320	32 cm	2 cm

Tortenbodenring, rund, perforiert

aus Edelstahl, fein perforiert zum besseren Belüften der Backware

Perforated Flan / Tart Ring

stainless steel, fine perforated for better pastry results



Art-Nr. Part No.	∅ dia. cm	Höhe Height cm
676/150	15	2
676/180	18	2
676/260	26	2



Art-Nr. Part No.	Länge Length cm	Breite Width cm	Höhe Height cm
639/160	16	16	5



Tortenring, Herzform
aus 2 mm starkem Aluminium

Cake Frame, Heart shaped
2 mm aluminium



Art-Nr. Part No.	Spatelmaß Blade cm	Länge gesamt Total Length cm
4054/150	15 x 3,5	33



Tortenringpalette

aus Edelstahl, seidmatt poliert, mit Griff aus Polyamid, mit 90° gekröpftem Spatel, zum Abstreichen überschüssiger Teigmasse vom Tortenring u.a.

Confectioner's Palette Knife

cranked 90°, flexible stainless steel, polyamide handle, useful for removing excess off the tops of cakes etc.



Art-Nr. Part No.	∅ dia.	Stärke Thickness
693/220	22 cm	1,2 mm
693/260	26 cm	1,2 mm
693/300	30 cm	1,2 mm
693/320	32 cm	1,2 mm
693/400	40 cm	1,2 mm



Tortenunterlage

aus Aluminium, mit Aufhängeloch, schwere Qualität

Cake Base

aluminium, with hole for hanging up, heavy gauge



Art-Nr. Part No.	Länge Length cm	Breite Width cm	Höhe Height cm
7562/325	32,5	22	23

Zwei Ständer passen auf ein GN 1/1 Tablett.
Two stands fit on a GN 1/1 tray.



Tortenunterlagenständer

Fächereinteilung aus 3 mm starkem Edelstahl, Rahmen aus 5 mm Edelstahl, spülmaschinenfest, mit Gummifüßchen, für 36 Tortenscheiben, schwere Qualität

Cake Bases and Stand

3 mm stainless steel wire, with 5 mm frame, dishwasher safe, with rubber feet, for 36 cake plates, heavy gauge



Art-Nr. Part No.	Länge Length cm	Breite Width cm	
6680/081	60	8	Mäander/Greek
6680/082	60	8	Platten/Columns
6680/083	60	8	Kugeln/Balls
6680/084	60	8	Rundbogen/Domes
6680/085	60	8	Wellen/Waves
6680/401	60	40	Mäander/Greek
6680/403	60	40	Kugeln/Balls
6680/404	60	40	Rundbogen/Domes
6680/405	60	40	Wellen/Waves

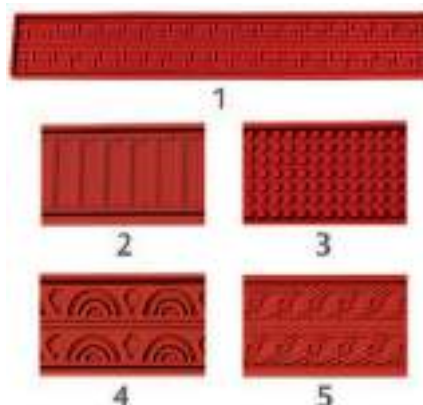

Tortenreliefmatten

aus rotem Silikon, einsetzbar von -60°C bis +230°C, klassische Frieze für den Tortenrand und für das Blech, spülmaschinengeeignet

Silicone Pastry Mats

flexible silicone, suitable for -60°C to +230°C, food and dishwasher safe



Schaumspeisenring, rund

aus Edelstahl 18/10, hochglänzend, nahtlos geschweißt

Mousse Ring

18/10 stainless steel, mirror polished, seamless



18/10
EDELSTAHL
STAINLESS STEEL

Art-Nr. Part No.	∅ dia.	Höhe Height
691/062	6,4 cm	3 cm
691/075	7,3 cm	4 cm

Schaumspeisenringe, rund

aus 1,2 mm starkem Edelstahl 18/10, hochglänzend, nahtlos geschweißt, schwere Qualität

Round Mousse Rings

1.2 mm thick 18/10 stainless steel, mirror polished, seamless, heavy gauge



18/10
EDELSTAHL
STAINLESS STEEL

Art-Nr. Part No.	∅ innen ∅ Inside	Höhe Height
697/002	6,8 cm	3,5 cm
697/092	8,8 cm	3,5 cm

Preis und Verpackung à 2 Stück
Priced/Packed in pairs.

Schaumspeisenring, rund

aus Edelstahl 18/10, seidenmatt poliert, fugenlos, auch als Ausstecher geeignet

Mousse Ring

18/10 stainless steel, satin polished, seamless



18/10
EDELSTAHL
STAINLESS STEEL

Art-Nr. Part No.	∅ innen ∅ Inside	Höhe Height
698/060	6 cm	6 cm
698/070	7 cm	8 cm
698/080	8 cm	6 cm
698/100	10 cm	5 cm

Drückstempel bitte separat bestellen: / Please order pusher separately:

698/506	6 cm
698/508	8 cm
698/510	10 cm

Schaumspeisenform, rechteckig

aus Edelstahl 18/10, hochglänzend poliert, nahtlos geschweißt

Mousse Frame

18/10 stainless steel, mirror polished finish, seamless



18/10
EDELSTAHL
STAINLESS STEEL

Art-Nr. Part No.	Fläche Size	Höhe Height
689/066	6 x 6 cm	4,5 cm
689/088	8 x 8 cm	4,5 cm
689/101	10 x 10 cm	4,5 cm
689/103	10 x 3 cm	4,5 cm
689/120	12 x 10 cm	5 cm
689/153	15 x 3 cm	2 cm
689/202	20 x 2 cm	2 cm

Drückstempel bitte separat bestellen: / Please order pusher separately:

689/566	6 x 6 cm
689/588	8 x 8 cm
689/511	10 x 10 cm

Schaumspeisenform, dreieckig

aus Edelstahl 18/10, fugenlos

Triangular Mousse Frame

18/10 stainless steel, seamless



18/10
EDELSTAHL
STAINLESS STEEL

Art-Nr. Part No.	Länge Length	Höhe Height
681/060	6 cm	4 cm
681/085	8,5 cm	4 cm
681/100	10 cm	4 cm

Drückstempel bitte separat bestellen: / Please order pusher separately:

681/506	6 cm
681/508	8,5 cm
681/510	10 cm



Art-Nr. Part No.	∅ Boden ∅ Base cm	Höhe Height cm	∅ innen ∅ Inside cm	
765/085	7,5	4	7,5	150 ml



Ragoutschälchen

aus Edelstahl 18/10, hochglänzend, zylindrische Form, mit gebördeltem Rand

Ramekin

18/10 stainless steel, mirror polished, rolled edge



Art-Nr. Part No.	∅ Boden ∅ Base cm	Höhe Height cm	∅ innen ∅ Inside cm	
4020/765	7,5	3,9	7,5	175 ml



Ragoutschälchen

aus Aluminium, eloxiert, zylindrische Form, mit gebördeltem Rand

Ramekin

anodised aluminium, rolled edge



Art-Nr. Part No.	∅ Boden ∅ Base cm	Höhe Height cm	∅ innen ∅ Inside cm	
750/075	4,8	4,8	7	150 ml



Puddingförmchen

aus Edelstahl 18/10, hochglänzend, gewölbte konische Form, gebördelter Rand

Pudding Basin

18/10 stainless steel, mirror polished, rolled edge



Art-Nr. Part No.	∅ Boden ∅ Base cm	Höhe Height cm	∅ innen ∅ Inside cm	
4022/065	4,5	4	6,5	100 ml
4022/075	5	5	7,2	175 ml



Puddingförmchen

aus Aluminium, eloxiert, leicht gewölbte konische Form, gebördelter Rand

Pudding Basin

anodised aluminium, rolled edge



Art-Nr. Part No.	∅ Boden ∅ Base cm	Höhe Height cm	∅ innen ∅ Inside cm	
4023/100	7	5,5	10	350 ml



Puddingförmchen

aus Aluminium, eloxiert, konische Form, gebördelter Rand

Pudding Basin

anodised aluminium, conical, rolled edge



Art-Nr. Part No.	∅ Boden ∅ Base cm	Höhe Height cm	∅ innen ∅ Inside cm	
5020/050	2,8	4,5	5	50 ml
5020/075	3,2	5,2	6	75 ml



Dariolform

aus Edelstahl 18/10, seidenmatt poliert, konische Form, mit glattem flachen Rand

Dariol / Timbale Mould

18/10 stainless steel, satin polished, conical, flat edge



Art-Nr. Part No.	∅ Boden ∅ Base cm	Höhe Height cm	∅ innen ∅ Inside cm	
518/012	4	4,5	6	100 ml



Dariolform

aus Edelstahl 18/10, seidenmatt poliert, konische Form, mit glattem flachen Rand

Dariol / Timbale Mould

18/10 stainless steel, satin polished, conical, flat edge



Dariolform

aus Edelstahl 18/10, seidenmatt poliert, konische Form, mit glattem flachen Rand

Dariol Mould

18/10 stainless steel, satin polished finish, conical, flat edge



Art-Nr. Part No.	∅ Boden ∅ Base cm	Höhe Height cm	∅ innen ∅ Inside cm	
510/010	5,5	3,5	7	100 ml
510/020	5,7	5,5	8,5	200 ml
510/030	6,3	6,5	9,5	300 ml
510/040	7,5	7	12	500 ml

Weitere Größen siehe Serie 507 auf Seite 76.
See page 76 for further sizes in range 507.

Dariolform

aus Edelstahl 18/10, hochglänzend poliert, mit gerade auslaufendem Rand, schwere Qualität

Dariol Mould

18/10 stainless steel, mirror polished, straight edge, heavy gauge



Art-Nr. Part No.	∅ Boden ∅ Base cm	Höhe Height cm	∅ innen ∅ Inside cm	
517/075	3,5	5	5	75 ml
517/125	4,5	6	6	125 ml
517/150	5	6,5	6,5	150 ml

Dariolform

aus Edelstahl 18/10, hochglänzend poliert, mit gerade auslaufendem Rand, mit extra starker Bodenrundung, schwere Qualität

Dariol Mould

18/10 stainless steel, mirror polished finish, straight edge, heavy gauge



Art-Nr. Part No.	∅ Boden ∅ Base cm	Höhe Height cm	∅ innen ∅ Inside cm	
519/075	3	5,5	5	75 ml
519/100	3,5	6	5,5	100 ml
519/150	4	6,5	6	150 ml

Dariolform

aus Edelstahl, hochglänzend, schwere Qualität

Dariol Mould

stainless steel, mirror polished, open edge, heavy gauge



Art-Nr. Part No.	∅ Boden ∅ Base cm	Höhe Height cm	∅ oben ∅ Top cm	
516/100	4	5,5	5,6	100 ml

Dariolform

aus Aluminium, eloxiert, mit gebördeltem Rand

Dariol Mould

anodised aluminium, rolled edge



Art-Nr. Part No.	∅ Boden ∅ Base cm	Höhe Height cm	∅ innen ∅ Inside cm	
4024/050	4	3,2	5	60 ml
4024/060	5	3,5	6	90 ml

Dariolform

aus Aluminium, eloxiert, konische Form, mit gebördeltem Rand

Dariol Mould

anodised aluminium, rolled edge



Art-Nr. Part No.	∅ Boden ∅ Base cm	Höhe Height cm	∅ innen ∅ Inside cm	
4021/050	4	5	5	75 ml
4021/055	4,5	6	5,5	120 ml

Antihaft-Dariolform

ganz aus Exoglass®, mit gebördeltem Rand, spülmaschinenfest

Non-Stick Dariol Mould

non-stick Exoglass®, rolled edge, dishwasher safe



Art-Nr. Part No.	∅ Boden ∅ Base cm	Höhe Height cm	∅ innen ∅ Inside cm	
6375/060	5	6	6	150 ml
6375/070	5	7	7	220 ml

Backzubehör

Rollen, kneten, mischen, rühren und glätten - hier finden Sie das Handwerkszeug für die Teigbearbeitung und -verfeinerung.

Baking Utensils

Everything you need for cakes, biscuits and icing.

Art-Nr. Part No.	Länge Length cm	Ø dia. cm	Walzenlänge Cylinder Length cm
Aus Buchenholz: / made from beechwood:			
823/250	44	6	25

Aus Gummibaumholz, kugelgelagert: / Made from rubberwood, roller spins:			
823/450	64	8,3	45

Grifflänge jeweils 9,5 cm (Ø 2,5 cm)
Handle length each 9.5 cm (Ø 2.5 cm)



Teigrolle

aus unbehandeltem naturbelassenen Hartholz, nicht spülmaschinengeeignet

Rolling Pin

unlacquered hard wood, not dishwasher proof



Art-Nr. Part No.	Länge Length cm	Ø dia. cm	Walzenlänge Cylinder Length cm
1717/490	47	6,5	25,5

Grifflänge jeweils 12 cm (Ø 3 cm)
Handle length each 12 cm (Ø 3 cm)



Teigrolle

ganz aus Edelstahl, hochglänzend, bewegliche Griffe, gekühlt für Butterteig oder angewärmt für Hefeteig zu gebrauchen, schwere Qualität

Rolling Pin

all stainless steel, mirror polished finish, roller spins, heavy gauge



Art-Nr. Part No.	Länge Length cm	Ø dia. cm	Walzenlänge Cylinder Length cm
1719/470	47	4,4	25

Grifflänge je 11 cm (Ø 2,5 cm)
Handle length each 11 cm (Ø 2,5 cm)



Teigrolle

aus Edelstahl 18/10, seidenmatt poliert, mit starr fixierten Griffen, schwere Qualität

Rolling Pin

18/10 stainless steel, satin polished finish, rigid fixed handles, heavy gauge



Art-Nr. Part No.	Länge Length cm	Ø dia. cm
822/500	50	4

Ausführung mit einem Griff: / With one handle:
822/801 78 4



Rollholz

aus unbehandeltem naturbelassenen Buchenholz, nicht spülmaschinengeeignet

Wooden Rolling Pin

unlacquered beechwood, not dishwasher safe



Rollwalze

aus Edelstahl 18/10, hochglänzend, schwere Qualität

Rolling Pin

18/10 stainless steel, mirror polished, heavy gauge



Art-Nr. Part No.	∅ dia. cm	Walzenlänge Cylinder Length cm
1725/500	5	50

Rollwalze

aus weißem Polyethylen

Rolling Pin

white polyethylene



Art-Nr. Part No.	∅ dia. cm	Walzenlänge Cylinder Length cm
1718/500	4,5	50

Ablage für Teigrollen

aus 5 mm starkem Edelstahl, zur Ablage von Teigrollen und Rollhölzern ab etwa 22 cm Walzenlänge

Rolling Pin Stand

5 mm stainless steel, for rolling pins of minimum 22 cm



Art-Nr. Part No.	Länge Length cm	Breite Width cm
1727/200	20	7

Lieferung ohne abgebildete Teigrolle.
Supplied without rolling pin.

Wender für Berliner

aus unbehandeltem naturbelassenen Buchenholz, leicht konisch geformt, nicht spülmaschinengeeignet, zum Wenden von Berlinern, Krapfen

Doughnut Turner

unlacquered smooth beechwood, tapered, not dishwasher safe



Art-Nr. Part No.	Länge Length cm	∅ min. cm	∅ max. cm
842/400	40	1	1,8

Brotdrücker

aus unbehandeltem naturbelassenen Buchenholz, zu den Enden verjüngende Form, nicht spülmaschinengeeignet

Roti / Chapati Roller

unlacquered smooth beechwood, tapered ends, not dishwasher safe



Art-Nr. Part No.	Länge Length cm	∅ min. cm	∅ max. cm
843/350	35	1	1,7

Rand-Teigrolle

aus Edelstahl 18/10, hochglänzend, mit handlichem Rohrgriff, leicht konische Walze, besonders zum Rollen in runden Backformen und an Rändern geeignet, schwere Qualität

Rolling Pin

18/10 stainless steel, mirror polished, tubular handle, slightly conical, enabling use in round baking tins, heavy gauge



Art-Nr. Part No.	Länge gesamt Total Length cm	∅ dia. cm	Stiellänge Handle Length cm	Walzenlänge Cylinder Length cm
1726/160	16,5	4,5	10	7,5



Art-Nr. Part No.	Breite Width cm	Stiellänge Handle Length cm
5103/180	18	20



Teigverteiler für Crêpes

aus Edelstahl 18/10, der untere horizontale Teil ist schwerer und erleichtert so das Arbeiten, hygienisch, hochwertig verarbeitete Qualität

Crêpe Tool

18/10 stainless steel, lower part heavier for improved handling, hygienic, heavy gauge



Art-Nr. Part No.	Breite Width cm	Stiellänge Handle Length cm
837/150	16	19



Teigverteiler für Crêpes

aus unbehandeltem naturbelassenen Buchenholz, nicht spülmaschinengeeignet

Crêpe Tool

unlacquered smooth beechwood, not dishwasher proof



Art-Nr. Part No.	Länge Length cm	Breite Width cm
840/035	35	3,5



Teigwender für Crêpes

aus unbehandeltem naturbelassenen Buchenholz, an beiden Seiten abgeflacht, nicht spülmaschinengeeignet

Crêpe Turner

unlacquered smooth beechwood, flat on both sides, not dishwasher safe



Art-Nr. Part No.	Breite Width cm	Höhe Height cm
3066/001	4	10



Teigmischer

aus Edelstahl, matt poliert, ideal zum Mischen von Teigzutaten, bzw. Einarbeiten von Butter in den Knetteig ohne diesen mit den Händen zu erwärmen

Pastry Mixer

stainless steel, matt polished finish



Art-Nr. Part No.	∅ Rad ∅ Wheel cm	Höhe Height cm	Breite max. Max. Width cm
5 glatte Rädchen: / 5 plain wheels:			
1032/005	5,4	24,5	50
6 glatte Rädchen: / 6 plain wheels:			
1032/006	5,4	24,5	60
7 glatte Rädchen: / 7 plain wheels:			
1032/007	5,4	24,5	70



Teigschneider

aus Edelstahl 18/0, hochglänzend, Schnittbreite justierbar von 10 bis 120 mm

Dough Cutter, adjustable

18/0 stainless steel, mirror polished finish, cutting width adjustable between 10 and 120 mm



Art-Nr. Part No.	∅ dia. cm	Höhe Height cm
669/300	30	1,5



Gitterteigstanze

zweiteilig, aus weißem Polystyrol, hitzeresistent bis +75°C, für Linzer Torte, Holländer-Gebäck usw.

Lattice Cutter Stencil

two piece, white polystyrene, heat resistant up to +75°C



Gitterschneider

aus weißem ABS-Kunststoff, hitzeresistent bis +120°C, Schnittbreite 7 mm, Schneidenlänge 35 mm, für gedeckten Blechkuchen, Strudel und Linzer Torte



Art-Nr. Part No.	Länge Length cm	∅ Rad ∅ Wheel cm	Walzenlänge Cylinder Length cm
1702/200	20	4	11

Lattice Cutter

white ABS, heat resistant up to +120°C, distance between wheels 7 mm, cut length 35 mm



Stiproller

aus weißem ABS-Kunststoff, hitzeresistent bis +120°C, Stippenabstand 20 mm, Stippenlänge 12 mm, Stippen oder Igeln von Brot, Pizza und Mürbeteig



Art-Nr. Part No.	Länge Length cm	Walzenlänge Cylinder Length cm
1701/200	20 cm	11,5 cm

Roller Docker

white ABS, heat resistant up to +120°C, distance between spikes 20 mm, pin length 12 mm



Kaisersemmeldrucker

aus weißem Kunststoff, Stange aus Edelstahl, Stempel rotiert beim Drücken, 20 mm Hub, nicht spülmaschinengeeignet



Art-Nr. Part No.	Länge Length cm	∅ dia. cm	∅ Stiel ∅ Handle cm
4088/200	20	6,5	3

Bread Stamp / Marker

white plastic, stainless steel spiral rod, stamp rotates under pressure, 20 mm stroke, not dishwasher safe



Brötchenteigdrucker

Spirale, aus gelbem Kunststoff

Bread Stamp / Marker

spiral shape, yellow plastic



Art-Nr. Part No.	∅ dia. cm	Höhe Height cm
4082/080	8	3,5



Brötchenteigdrucker

Kaisersemmel, aus gelbem Kunststoff

Bread Stamp / Marker

Kaisersemmel shape, yellow plastic



Art-Nr. Part No.	∅ dia. cm	Höhe Height cm
4084/084	8	3,5



Brötchenteigdrucker

Kaisersemmel mit Loch, aus gelbem Kunststoff

Bread Stamp / Marker

Kaisersemmel shape, with hole, yellow plastic



Art-Nr. Part No.	∅ dia. cm	Höhe Height cm
4085/085	8	3,5



Kochlöffel und Rührspatel

Spoons and Paddles

Art-Nr. Part No.	Löffelmaß Bowl Size cm	Länge gesamt Total Length cm
832/025	7 x 5	25
832/030	8 x 5,5	30
832/035	8 x 5,5	35



Kochlöffel, oval

extra stark, aus unbehandeltem naturbelassenen Buchenholz, nicht spülmaschineneeignet

Oval Wooden Spoon

unlacquered smooth beechwood, not dishwasher proof



Art-Nr. Part No.	Länge Length cm	∅ Löffel ∅ Spoon cm	∅ Stiel ∅ Handle cm
833/024	24	4,5	0,9
833/030	30	4,9	1,0
833/032	32	5,1	1,1
833/036	36	5,3	1,2
833/040	40	5,8	1,2
833/045	45	6	1,4
833/050	50	7	1,4
833/060	60	8	1,5
833/080	80	9	1,8
833/100	100	10	2,0



Kochlöffel, rund

aus unbehandeltem naturbelassenen Buchenholz, nicht spülmaschineneeignet

Round Wooden Spoon

unlacquered smooth beechwood, not dishwasher proof



Art-Nr. Part No.	Löffelmaß Bowl Size cm	Länge gesamt Total Length cm
6933/300	7,5 x 5	30
6933/380	9 x 6	38
6933/450	11 x 7	45



Kochlöffel

aus braunem bruchfestem Exoglass®, sehr robust, hitzeresistent bis +220°C, tiefe runde Löffelform

Exoglass® Spoon

brown, deep round bowl, heat resistant up to +220°C, unbreakable



Art-Nr. Part No.	Länge Length cm	Breite Width cm
6931/250	25	4
6931/300	30	5
6931/350	35	5,5
6931/400	40	6,5
6931/500	50	8,5



Rührspatel

aus weißem Exoglass®, hitzeresistent bis +220°C, bruchfest, sehr robust, mit Aufhängeöse

Spatula

white Exoglass®, heat resistant up to +220°C, unbreakable, with hanging loop



Art-Nr. Part No.	Spatelmaß Blade	Länge gesamt Total Length
919/085	32 x 11 cm	80 cm
919/100	32 x 11 cm	100 cm
919/120	32 x 11 cm	120 cm

dauerhaft temperaturbeständig bis +80°C, kurzfristig bis +110°C: / heat resistant up to +80°C, up to 110°C briefly:

919/085 32 x 11 cm 80 cm

919/100 32 x 11 cm 100 cm

919/120 32 x 11 cm 120 cm

919/150 32 x 11 cm 150 cm

Art-Nr. Part No.	Spatelmaß Blade cm	Länge gesamt Total Length cm
1030/060	23 x 12	61
1030/105	23 x 12	105
1030/120	23 x 12	120
1030/150	23 x 12	150



Rührspatel, perforiert

aus weißem hochmolekularem Polyethylen, mit Stiel aus Edelstahl 18/10, absolut wasserdicht, Stieldicke 3 cm, Lochdurchmesser 2,5 cm, extra schwere Qualität

Paddle, perforated

white high molecular polyethylene, with 18/10 stainless steel handle, watertight seal, 25 mm ∅ holes, 30 mm ∅ handle, extra heavy gauge



Rührspatel

ganz aus Edelstahl, hochglänzend, Stieldicke 2,5 cm, Materialstärke des Spatels: 2,0 mm, schwere Qualität

Paddle

all stainless steel, mirror polished finish, hollow handle ∅ 2.5 cm, blade 2 mm thick, heavy gauge



Kochspatel

aus weißem thermoelastischen Spezialkunststoff, mit Exoglass®-Griff, extrem hitzeresistent bis +260°C, kann beim Kochvorgang in Topf oder Pfanne verbleiben, bruchfest und strapazierfähig

Spatula

white thermo elastic plastic, with Exoglass® handle, extremely heat resistant up to +260°C, virtually unbreakable, can remain in the pot/pan while cooking



Art-Nr. Part No.	Spatelmaß Blade cm	Länge gesamt Total Length cm
1975/350	11,5 x 7	35
1975/400	11,5 x 7	45



Teigspatel

aus weißem thermoelastischen Kunststoff, mit Exoglass®-Griff, hitzeresistent bis +70°C, bruchfest und strapazierfähig

Spatula

white thermo elastic plastic, with Exoglass® handle, heat resistant up to +70°C, unbreakable



Art-Nr. Part No.	Spatelmaß Blade cm	Länge gesamt Total Length cm
190/250	8 x 5	25
190/350	11,5 x 7	35
190/450	11,5 x 7	45



Teigspatel

mit weich-elastischem Schaber aus Silikon, hitzeresistent bis +110°C, Griff aus Edelstahl 18/10

Spatula

white elastic silicone, heat resistant up to +110°C, with 18/10 stainless steel handle



Art-Nr. Part No.	Fläche Size cm	Länge gesamt Total Length cm
192/190	6 x 3	19
192/260	9 x 5	26
192/320	12 x 7,5	32



Teigspatel

Serie POLARIS, mit Griff aus Edelstahl 18/10, mit weichem Gummi-Spatel

Spatula

with 18/10 stainless steel handle, rubber blade



Art-Nr. Part No.	Spatelmaß Blade cm	Länge gesamt Total Length cm
976/290	9 x 5	29



Teigspatel

aus thermoplastischem Kunststoff

Spatula/Scraper

white thermoplastic



Art-Nr. Part No.	Spatelmaß Blade cm	Stiellänge Handle Length cm
1986/230	9 x 5	14





Art-Nr. Part No.	Spatelmaß Blade cm	Stiellänge Handle Length cm
1987/230	7 x 2,7	18



Teigspatel
aus thermoplastischem Kunststoff

Spatula/Scraper
white thermoplastic



Art-Nr. Part No.	Spatelmaß Blade cm	Stiellänge Handle Length cm
1988/260	12 x 6,5	14



Teigspatel
aus thermoplastischem Kunststoff

Spatula/Scraper
white thermoplastic



Art-Nr. Part No.	Breite Width cm	Länge gesamt Total Length cm
1989/190	5	19



Teigspatel
aus weißem ABS

Spatula/Scraper
white ABS



Art-Nr. Part No.	Spatelmaß Blade cm
4075/130	13 x 6

Materialstärke 0,3 mm
Blade thickness 0.3 mm



Teigschaber
aus flexiblem Edelstahl 18/0, matt,
mit Griff aus weißem Polypropylen, mit Aufhängeloch

Dough Scraper
18/0 stainless steel, flexible blade,
white polypropylene handle with hanging hole



Art-Nr. Part No.	Spatelmaß Blade cm
4067/150	15 x 7,5

Materialstärke 0,9 mm
Blade thickness 0.9 mm



Teigabstecher
aus starrem Edelstahl 18/0, matt poliert,
mit Griff aus weißem Polypropylen, schwere Qualität

Dough Scraper
18/0 stainless steel, rigid blade, matt polished finish,
with white polypropylene handle



Teigschaber

aus 0,6 mm starkem flexiblen Polypropylen

Spatula/Scraper

very flexible 0.6 mm thick polypropylene

PP
POLY-
PROPYLENE



Art-Nr. Part No.	Spatelmaß Blade cm
3061/130	13 x 10

Teigschaber Set

dreiteilig, aus elfenbeinfarbenem Polypropylen

Scraper Set

3 piece, crème coloured polypropylene

PP
POLY-
PROPYLENE



Art-Nr. Part No.	Länge Length cm	Breite Width cm
3062/003	12	8,5

Kesselschaber

aus elfenbeinfarbenem ABS-Kunststoff

Spatula/Scraper

ABS plastic

ABS
ACRYLON-
NITRILE



Art-Nr. Part No.	Länge Length cm	Breite Width cm
3063/200	19,5	15

Kammschaber

aus Edelstahl 18/10, hochglänzend, mit Aufhängeloch,
mit elf 10 mm tiefen Zacken

Decorating Comb

18/10 stainless steel, mirror polished finish,
with 11 prongs 10 mm deep

18/10
EDELSTAHL
STAINLESS STEEL



Art-Nr. Part No.	Länge Length cm	Breite Width cm
663/011	11	8

Materialstärke: 0,8 mm
Blade thickness: 0,8 mm

Fondantglätter

aus weißem Kunststoff, zum Glätten von Fondant
und Marzipan

Fondant Smoother

white plastic, for smoothing fondant

PS
POLYSTYRENE



Art-Nr. Part No.	Fläche Size cm	Höhe Height cm
Halbrunde Form: / Semi round shape:		
1750/160	16 x 8	2,5
Rechtwinklige Form: / Rectangular shape:		
1750/161	16 x 8	2,5

Paletten

Spatulas/Palette Knives

Art-Nr. Part No.	Spatelmaß Blade cm	Länge gesamt Total Length cm
3650/260	26 x 3,5	39,5



Konditorpalette

flexibles geschmiedetes Blatt aus Chrom-Molybdän-Vanadium (DIN x50CrMoV15), Griff aus POM-Kunststoff, spülmaschinengeeignet,

Palette Knife

Molybdenum Vanadium flexible stainless steel blade, with black POM handle, professional quality



Art-Nr. Part No.	Spatelmaß Blade cm	Länge gesamt Total Length cm
4063/200	20 x 2,5	33
4063/250	25 x 2,5	38
4063/300	30 x 2,5	43



Konditorpalette

aus flexiblem Edelstahl 18/0, hochglänzend, mit Griff aus weißem Polypropylen

Palette Knife

flexible 18/0 stainless steel blade, mirror polished finish, with white polypropylene handle



Art-Nr. Part No.	Spatelmaß Blade cm	Länge gesamt Total Length cm
942/340	21 x 3	34



Konditorpalette

Serie POLARIS, mit Griff aus Edelstahl 18/0, flexibler Spatel aus Edelstahl 18/0

Palette Knife

with hanging loop, handle 18/0 stainless steel, flexible blade 18/0 stainless steel



Art-Nr. Part No.	Spatelmaß Blade cm	Klingenlänge Blade Length Zoll
3725/260	26 x 3,5	10"



Winkelpalette

mit gekröpftem Spatel, aus Chrom-Molybdän-Vanadium (DIN x50CrMoV15), Klinge vorne geschärft, Griff aus POM-Kunststoff, spülmaschinengeeignet,

Confectioner's Palette Knife

cranked, with flexible blade, molybdenum vanadium stainless steel, with POM handle, professional quality



Art-Nr. Part No.	Spatelmaß Blade cm	Klingenlänge Blade Zoll
4057/250	25,5 x 3,5	10"



Winkelpalette

aus Edelstahl, seidenmatt poliert, mit Griff aus schwarzem Polypropylen, gekröpfter Spatel

Confectioners Palette Knife

cranked, stainless steel, satin polished finish, with polypropylene handle



Art-Nr. Part No.	Spatelmaß Blade cm	Länge Length cm
2274/095	9,5 x 2	21,5
2274/120	12 x 2,4	25



Confiserie-Palette

flexibler Edelstahl 18/0, Griff aus schwarzem glasfaser-verstärkten Polyamid

Confectioners Palette Knife

flexible 18/0 stainless steel, black fibreglass reinforced polyamide handle



Art-Nr. Part No.	Spatelmaß Blade cm	Länge Length cm
2276/092	9,2 x 2	21,5
2276/117	11,7 x 2,4	24,5



Confiserie-Winkelpalette

mit gekröpftem Spatel, flexibler Edelstahl 18/0, Griff aus schwarzem glasfaserverstärkten Polyamid

Confectioners Palette Knife

cranked, flexible 18/0 stainless steel, fibreglass reinforced polyamide handle



Fett-/ Kuchenpinsel

mit verschweißtem Stiel aus cremefarbenem Polycarbonat, roter Schaft mit 6 cm langen Naturborsten, temperaturresistent bis +120°C

Pastry Brush

6 cm natural bristles, with sealed cream coloured polycarbonate handle and red strip, heat resistant up to +120°C



PC
POLYCARBONATE

Art-Nr. Part No.	Länge Length	Breite Width
1715/025	23,5 cm	25 mm
1715/030	24,5 cm	30 mm
1715/035	25 cm	35 mm
1715/040	25,5 cm	40 mm
1715/050	27 cm	50 mm

Fett-/ Kuchenpinsel

mit verschweißtem Stiel aus cremefarbenem Polycarbonat, dunkelroter Schaft und 5 cm langen Borsten aus besonders strapazierfähigem Polyamid, temperaturresistent bis +120°C

Pastry Brush

sturdy 5 cm polyamide bristles with sealed cream coloured polycarbonate handle and red strip, heat resistant up to +120°C



PA
POLYAMIDE

PC
POLYCARBONATE

Art-Nr. Part No.	Länge Length	Breite Width
1720/030	22 cm	30 mm
1720/040	23 cm	40 mm
1720/050	24 cm	50 mm
1720/060	25 cm	60 mm
1720/070	24 cm	70 mm

Fett-/ Kuchenpinsel

mit verschweißtem Stiel aus cremefarbenem Polyamid, dunkelroter Schaft und 4 cm langen Naturborsten, temperaturresistent bis +120°C

Pastry Brush

4 cm natural bristles with sealed cream coloured polyamide handle and red strip, heat resistant up to +120°C



PA
POLYAMIDE

Art-Nr. Part No.	Länge Length	Breite Width
1716/060	24,5 cm	60 mm
1716/075	24,5 cm	75 mm

Silikon Backpinsel

aus Edelstahl 18/10, hochglänzend poliert, 4 cm lange Silikon-Borsten, temperaturresistent bis +260°C, spülmaschinengeeignet

Silicone Pastry Brush

18/10 stainless steel, mirror polished, with 4 cm silicone bristles, brush heat resistant up to +260°C (500°F), dishwasher safe



18/10
EDELSTAHL
STAINLESS STEEL

SILIKON
SILICONE

SPÜLMASCHINENGEEIGNET
DISHWASHER SAFE

Art-Nr. Part No.	Länge Length	Breite Width
1721/210	21 cm	40 mm

Drahtpinsel

mit feinen Messingborsten, mit Holzgriff, zum Aufrauen glatter Oberflächen

Wire Brush

fine brass bristles, with wooden handle



MESSING
BRASS

HOLZ
WOOD

Art-Nr. Part No.	Länge Length	Breite Width
5865/050	22 cm	5 cm



Art-Nr. Part No.	∅ dia. cm	Länge Length cm	Größe Size	
1710/250	11	25	0	0,65 l
1710/280	12	28	1	0,7 l
1710/340	13	34	2	1,5 l
1710/400	15	40	3	2,3 l
1710/480	17	46	4	3,5 l
1710/500	18	50	5	4,3 l
1710/600	19	55	6	5,5 l
1710/700	21	60	7	6,5 l



Spritzbeutel

aus mehrfach beschichteter Baumwolle, lebensmittelecht, kochfest, geeignet für alle Massen, mit verstärktem Saum und Spitze, verschweißte Längsnaht, auch nach längerem Gebrauch geschmeidig

Piping Bag

multi coated cotton, with reinforced tip and seam, can be boiled, impermeable, suitable for all mixtures, flexible even after long use



Art-Nr. Part No.	∅ dia. cm	Länge Length cm	
1704/550	17,5	55	3,5 l



Einweg-Spritzbeutel

aus transparentem Polyethylen, Materialstärke 90 µm (Mikron), Rolle mit 100 Beuteln

Disposable Piping Bag

90 microns transparent polyethylene, box of 100 bags



Art-Nr. Part No.	∅ dia. cm	Länge Length cm	
1705/500	17	50	2 l



Einweg-Spritzbeutel

aus grünem mehrschichtigem Polyethylen, Materialstärke 80 µm (Mikron), sehr griffig, Rolle mit 100 Beuteln

Disposable Piping Bags

80 micron green polyethylene, box of 100 bags



Art-Nr. Part No.	∅ oben ∅ Top	Höhe gesamt Overall Height
---------------------	-----------------	-------------------------------

Für Beutelgröße 0 - 4: / For Bags size 0 - 4:		
1707/001	10 cm	24 cm

Für Beutelgröße 4 - 7: / For Bags size 4 - 7:		
1707/002	14 cm	31,5 cm



Spritzbeutelständer

aus Edelstahl 18/10, hochglänzend, mit Spülwasserablauf im Fuß, schwere Qualität

Piping Bag Stand

18/10 stainless steel, mirror polished finish, with hole in the foot to let water drain, heavy gauge



Art-Nr. Part No.	Breite Width cm	Höhe Height cm
670/500	50	26



Spritzbeutelaufräger

aus Edelstahl, elektrolytisch poliert, zur Wand-aufhängung, für max. 4 Spritzbeutel, schwere Qualität

Wallrack for 4 Piping Bags

stainless steel, electro-polished



Art-Nr. Part No.	Breite Width cm	Höhe Height cm
677/260	26	53,5



Spritzbeutel/-tüllenaufhänger

aus Edelstahl 18/10, elektrolytisch poliert, zur Wand-aufhängung, für 2 Spritzbeutel und max. 7 Spritztüllen

Wallrack for Piping Bags/ Tubes

18/10 stainless steel, electro-polished, for 2 piping bags and up to 7 tubes



Lochtülle

aus Edelstahl 18/10, seidenmatt poliert, fugenlos gezogen

Plain Piping/Pastry Tube

18/10 stainless steel, satin polished, seamless welded

18/10
EDELSTAHL
STAINLESS STEEL



Art-Nr. Part No.	∅ Loch ∅ Hole	Länge Length cm
710/004	4 mm	5
710/006	6 mm	5
710/007	7 mm	5
710/008	8 mm	5
710/010	10 mm	5
710/011	11 mm	5
710/012	12 mm	5
710/013	13 mm	5
710/014	14 mm	5

Sterntülle

aus Edelstahl 18/10, seidenmatt poliert, fugenlos gezogen

Star Piping/Pastry Tube

18/10 stainless steel, satin polished, seamless welded

18/10
EDELSTAHL
STAINLESS STEEL



Art-Nr. Part No.	∅ Loch ∅ Hole	Länge Length cm
711/004	4 mm	5
711/006	6 mm	5
711/007	7 mm	5
711/008	8 mm	5
711/009	9 mm	5
711/010	10 mm	5
711/011	11 mm	5
711/012	12 mm	5
711/014	14 mm	5

Lochtüllensatz

aus Edelstahl 18/10, fugenlos gezogen, matt gebürstet, Set mit 9 Stück, Lochdurchmesser 4 bis 15 mm

Plain Piping/Pastry Tubes

18/10 stainless steel, seamless, matt brushed finish, box of 9 sizes, diameter 4 to 15 mm

18/10
EDELSTAHL
STAINLESS STEEL



Art-Nr. Part No.	Höhe Height cm
1708/010	5 cm

Sterntüllensatz

aus Edelstahl 18/10, fugenlos gezogen, matt gebürstet, Set mit 9 Stück, Lochdurchmesser 4 bis 15 mm

Star Piping/Pastry Tubes

18/10 stainless steel, seamless, matt brushed finish, box of 9 sizes, diameter 4 up to 15 mm

18/10
EDELSTAHL
STAINLESS STEEL



Art-Nr. Part No.	Höhe Height cm	∅ max. cm
1709/010	5 cm	3,5

Spritztüllensatz

7 nahtlose Spritztüllen, aus Edelstahl 18/10, seidenmatt gebürstet, mit einem Spritzbeutel aus weißem Polyamid

Piping/Pastry Tubes

7 pastry tubes, 18/10 stainless steel, brushed finish, supplied with one white polyamide piping bag

18/10
EDELSTAHL
STAINLESS STEEL

PA
POLYAMID



Art-Nr. Part No.	Höhe Height cm	∅ max. cm
1711/007	5 cm	3,5

Spritztüllensatz, klein

8 nahtlose Mini-Spritztüllen, aus Edelstahl 18/10, seidenmatt gebürstet, mit einem Spritzbeutel aus weißem Polyamid

Piping/Pastry Tubes

8 pastry tubes, 18/10 stainless steel, brushed finish, supplied with one white polyamide piping bag

18/10
EDELSTAHL
STAINLESS STEEL

PA
POLYAMID



Art-Nr. Part No.	Höhe Height cm	∅ unten ∅ Base cm
1713/008	3 cm	1,8 cm



Art-Nr. Part No.	Höhe Height
1712/006	6 cm



Lochtüllensatz

aus cremefarbenem Polypropylen, temperaturresistent bis +120°C, bruchfest, sterilisierbar, sechsteilig mit Lochgrößen Ø 3, 5, 7, 9, 11, 13 mm

Plain Piping/Pastry Tubes

polypropylene, heat resistant up to +120°C, unbreakable, hygienic, 6 sizes: Ø 3, 5, 7, 9, 11, 13 mm



Art-Nr. Part No.	Höhe Height
1714/006	6 cm



Sterntüllensatz

aus cremefarbenem Polypropylen, temperaturresistent bis +120°C, bruchfest, sterilisierbar, sechsteilig mit Lochgrößen Ø 3, 5, 7, 9, 11, 13 mm

Star Piping/Pastry Tubes

polypropylene, heat resistant up to +120°C, unbreakable, hygienic, with 6 sizes: Ø 3, 5, 7, 9, 11, 13 mm



Art-Nr. Part No.	Höhe Height
1731/024	5,5 cm

Tüllen sind auch einsetzbar in Gebäckpresse 4486 von Seite 262.
Tubes fit to pastry press 4486 on page 262.



Spritztüllensatz

24 verschiedene (12 Sterne, 10 runde, 2 sonstige) Tüllen, aus Polycarbonat

Piping/Pastry Tubes

24 different (12 star, 10 round, 2 other) polycarbonate tubes



Art-Nr. Part No.	Höhe Height	Ø Durchlauf Ø Nozzle	Ø max. cm
1732/085	7,5 cm	1,9 cm	4,5 cm



Spritztüllenadapter

aus POM-Kunststoff, mit Schraubverschluss

Piping/Pastry Tube Adapter

POM plastic



Art-Nr. Part No.	Ø max. cm	Länge Length	Ø Durchlauf Ø Nozzle
687/090	2,5 cm	9 cm	4 mm



Berliner Tülle

aus Edelstahl, fugenlos, eignet sich zum Füllen von Hefebällen, Trüffelkugeln etc.

Doughnut Filling Tube

stainless steel



Art-Nr. Part No.	Ø max. cm	Länge Length
685/120	3 cm	12 cm
685/140	3,5 cm	14 cm
685/160	4 cm	16 cm



Schillerlockenform

Cornet-Förmchen, aus Edelstahl 18/0

Cream Horn Mould

18/0 stainless steel



Art-Nr. Part No.	Ø dia.	Länge Length
682/022	2,2 cm	14 cm
682/027	2,7 cm	14 cm



Crème-Rolle

aus Edelstahl 18/10

Cream Tube Mould

18/10 stainless steel



Gebäckpresse

aus Polycarbonat, einstellbarer Vorschub, geeignet auch für zähflüssige Speisen, Lieferung mit einem Nachfüllbehälter, sowie einer Loch- und einer Sterntülle

Piping Tube

polycarbonate, feed control, suitable for viscous food, supplied with one refill tube, one plain round and one star pastry tube



PC
POLYCARBONATE

Art-Nr. Part No.	Länge Length cm	∅ dia. cm	
4486/385	38,5	10,5	0,75 l
4486/975	Zusatz-Nachfüllbehälter / Refill tube		
1731/024	Spritztüllensatz 24-teilig / Pastry tube set (24 pieces)		

Gasbrenneraufsatz/ Karamellisierer

für die Gastronomie optimiert, direkter Anschluss an handelsübliche Gaskartuschen mit EU-Schraubgewinde UNEF 7/16", das Umfüllen ist nicht mehr nötig, stabile Konstruktion mit rutschfestem Griff für Einhandbedienung, verschleißfreie Piezo-Zündung, einstellbare Flamme

Chef's Blow Torch Head

ideal for caramelizing, melting cheese, skinning tomatoes and peppers etc., easy and safe operation, piezo trigger auto ignition, adjustable flame, works at any angle



FIBER
FIBERGLAS
FIBREGLASS

Art-Nr. Part No.	Länge Length cm	∅ dia. cm	Stiellänge Handle Length cm
7541/250	15	2	12

Lieferung ohne Gaskartuschen. Durch den größeren Winkel des Handgriffs können auch bauchige Gaskartuschen angeschlossen werden.

Supplied without cartridge. Fits most standard European gas cartridges,

Gasbrenner/ Karamellisierer

befüllbar mit Feuerzeuggas, eine Füllung reicht für ca. 60 min Betrieb, stabile Metallkonstruktion mit rutschfestem Kolben für Einhandbedienung, Sicherheitsschalter, verschleißfreie Piezo-Zündung

Chef's Blow Torch

chrome effect, non-slip sure grip metal body, piezo trigger auto ignition, safety lock, uses butane lighter fuel, burn time approx. 60 min, can be used at any angle, supplied without fuel



ALU
ALUMINIUM

FIBER
FIBERGLAS
FIBREGLASS

Art-Nr. Part No.	∅ Griff ∅ Handle cm	Höhe Height cm
7538/850	3	15

Sahnespender

ganz aus Edelstahl 18/10, mit drei auswechselbaren Garniertüllen, ideal zur Bereitung von Sahne, Espumas, sowie zum Aufschäumen kalter und warmer Saucen, spülmaschinengeeignet, hochqualitative Ausführung

Cream Whipper

18/10 stainless steel, with 3 different nozzles, dishwasher safe

18/10
18/10 STAHL
STAINLESS STEEL

SPÜLMASCHINENGEEIGNET
DISHWASHER SAFE



Art-Nr. Part No.	∅ max. cm	Höhe gesamt Overall Height cm
---------------------	--------------	-------------------------------------

einwandig, seidenmatt gebürstet: / single walled, satin brushed finish:

5551/051	0,5 l	8	29
5551/101	1 l	10	30

doppelwandige hochglänzende Thermo-Ausführung: / double-walled mirror polished Thermo version:

5553/050	0,5 l	10	26
----------	-------	----	----

Einwegkapseln für Sahnebereiter

aus Aluminium, gefüllt mit Distickstoffmonoxid, geeignet für alle handelsüblichen Sahnebereiter

Bulbs for Professional Whipper

aluminium, filled with nitrous oxide

ALU
ALUMINIUM



Art-Nr. Part No.	
5558/024	Satz mit 24 Stück / Packed/priced per box of 24 pieces



Art-Nr.	Gewicht
Part No.	Weight
1734/001	1 kg



Backkugeln

aus Keramik, gewährleistet einen ebenen, gleichmäßigen Tortenboden

Baking Beans

ceramic, ensure a flat and even pastry base



Art-Nr.	Länge
Part No.	Length
527/350	35 cm



Zuckerthermometer

aus Glas in grauer Polyamid-Halterung, nichttoxischer Alkohol, Messbereich +80°C bis +200°C

Sugar Thermometer

glass in grey polyamide frame, graduated +80°C to +200°C



Art-Nr.	Länge
Part No.	Length
522/160	29,5 cm



Zuckerwaage / Dichtemesser

Saccharometer (Aräometer), graduiert in 1000-1400 g/l und in 15-40° Baumé, aus Glas, geeignet auch für Salzlösungen

Saccharometer

graduated 1000-1400 g/l and 15-40° Baumé, glass



Art-Nr.	Länge	Ø Durchlauf
Part No.	Length	Ø Nozzle
4484/200	25 cm	6 mm



Zuckerblasebalg

13 cm lange Pipette aus Aluminium, Blasebalg aus Gummi, zur Herstellung von feinstem Zuckerdekor

Sugar Pump

13 cm long aluminium tube, with rubber pump, for superb sugar craft



Art-Nr.	Länge gesamt
Part No.	Total Length
3344/520	52,5 cm

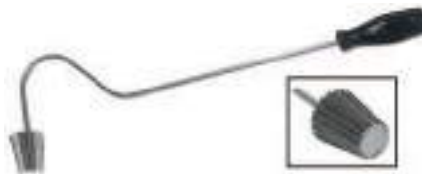

Pasteteneisen

aus rohem Eisenguss, Form rund gerippt, Kolbendurchmesser 5 cm oben und 3,5 cm unten, Kolbenhöhe 4 cm, Stiel aus Edelstahl 18/10, mit Kunststoff-Griff, zur Herstellung von Pastetenhüllen wie Vol au vent

Fluted Pastry tool

raw cast iron, fluted top diameter 5 cm, base diameter 3.5 cm, height 4 cm, rod made of 18/10 stainless steel, with plastic handle, for making pâté casings such as vol au vent



Art-Nr.	Länge	Breite
Part No.	Length	Width
1735/600	64 cm	5 cm



Backlineal

aus weißem Polystyrol, in Zentimeter und 8/12 cm - Skalierung

Baking Ruler

white polystyrene, centimetre and 8/12 cm scale



Marzipan-Modellierset

aus ABS Kunststoff, 12-teilig in einer Dose

Marzipan Sculpting Set

ABS plastic, 12 piece boxed



Art-Nr.	Länge
Part No.	Length
1733/012	14 cm



Teig-/Marzipankneifer

aus Edelstahl 18/0, hochglänzend, vorne gezackt

Pastry/Marzipan Crimper

18/0 stainless steel, mirror polished finish



Art-Nr.	Länge	Breite
Part No.	Length	Width
811/100	10 cm	1,8 cm



Mehlbürste

mit Kunststoffborsten, mit weißem Kunststoffgriff, lebensmittelgeeignet, spülmaschineneeignet

Flour Brush

plastic bristles, white plastic handle, food safe, dishwasher safe



Art-Nr.	Länge	Breite	Borstenlänge
Part No.	Length	Width	Bristle Length
1729/300	29 cm	3 cm	6 cm



Nussknacker

aus massivem Edelstahl 18/0, seidenmatt poliert, formschönes, handliches Design, schwere Qualität

Nutcracker

18/0 stainless steel, satin polished finish, elegant design, heavy gauge



Art-Nr.	Länge
Part No.	Length
450/290	19 cm



Nussknacker

aus Zinkguss, hochglänzend verchromt

Nutcracker

zinc alloy, mirror chrome plated



Art-Nr.	Länge
Part No.	Length
451/155	15,5 cm



Nussknacker

aus Aluminiumguss, Gummieinlage an der Grifffläche, mit Federmechanismus, nicht spülmaschineneeignet, zum Knacken von Walnüssen, Haselnüssen als auch Paranüssen

Nutcracker

cast aluminium, rubber inlay in handle, spring mechanism, not dishwasher safe, for cracking walnuts, hazelnuts as well as other nuts



Art-Nr.	Länge	∅	Tiefe
Part No.	Length	dia.	Depth
1071/185	18,5 cm	4 cm	6 cm





Art-Nr. Part No.	Länge Length m m	Höhe Height m m
615/006	30 - 70	30



Ausstecher, quadratisch

glatte Form, aus Weißblech, sechs Stück komplett in einer Dose (Ø 10,5 cm)

Square Plain Cutters

tin plated, 6 piece set complete with Ø 10.5 cm tin



Art-Nr. Part No.	Länge Length m m	Höhe Height m m
616/006	23 - 85	30



Ausstecher, quadratisch

gewellte Form, aus Weißblech, sechs Stück komplett in einer Dose (Ø 10,5 cm)

Square Fluted Cutters

tin plated, 6 piece set complete with Ø 10.5 cm tin



Art-Nr. Part No.	Ø dia. m m	Höhe Height m m
618/014	22 - 113	30



Ausstecher, rund

glatte Form, aus Weißblech, 14 Stück komplett in einer Dose (Ø 12,5 cm)

Round Plain Cutters

tin plated, 14 piece set complete with Ø 12.5 cm tin



Art-Nr. Part No.	Ø dia. m m	Höhe Height m m
617/014	20 - 110	30



Ausstecher, rund

gewellte Form, aus Weißblech, 14 Stück komplett in einer Dose (Ø 12,5 cm)

Round Fluted Cutters

tin plated, 14 piece set complete with Ø 12.5 cm tin



Art-Nr. Part No.	Größe Size m m	Höhe Height m m
620/009	25x20 - 85x72	30



Ausstecher, oval

glatte Form, aus Weißblech, neun Stück komplett in einer Dose

Oval Plain Cutters

tin plated, 9 piece set complete with tin



Art-Nr. Part No.	Größe Size m m	Höhe Height m m
619/009	25x20 - 80x65	30



Ausstecher, oval

gewellte Form, aus Weißblech, neun Stück komplett in einer Dose

Oval Fluted Cutters

tin plated, 9 piece set complete with tin



Ausstecher 'Buchstaben'

aus Weißblech, 26 Buchstaben komplett in einer Dose
(Ø 12,5 cm)

Alphabet Cutters

tin plated, 26 letters set complete with Ø 12.5 cm tin



Art-Nr. Part No.	Länge Length mm	Höhe Height mm
613/130	25	20

Ausstecher 'Zahlen'

aus Weißblech, alle Ziffern komplett in einer Dose
(Ø 10,5 cm)

Number Cutters

tin plated, numbers set complete with Ø 10.5 cm tin



Art-Nr. Part No.	Höhe Height mm	Breite Width mm
614/010	35 - 40	15 - 25

Ausstechformen, 'Herz'

aus Weißblech, sechs Stück in einer Dose (Ø 10 cm)

Heart Shaped Cutters

tin plated, 6 piece set complete with Ø 10 cm tin



Art-Nr. Part No.	Länge Length mm	Höhe Height mm
631/006	45 - 93	30

Ausstechformen, 'Stern'

aus Weißblech, sieben Stück in einer Dose (Ø 15 cm)

Star Shaped Cutters

tin plated, 7 piece set complete with tin Ø 15 cm tin



Art-Nr. Part No.	Ø dia. mm	Höhe Height mm
632/007	25 - 140	20

Ausstechformen 'Blüte'

aus Weißblech, sechs Stück in einer Dose (Ø 10 cm)

Petal Shaped Cutters

tin plated, 6 piece set complete with Ø 10 cm tin



Art-Nr. Part No.	Ø dia. mm	Höhe Height mm
636/006	40 - 95	30

Ausstecher Sortiment

aus Weißblech, verschiedene Formen komplett in einer
Weißblech-Dose

Aspic Cutters

tin plated, set complete with tin

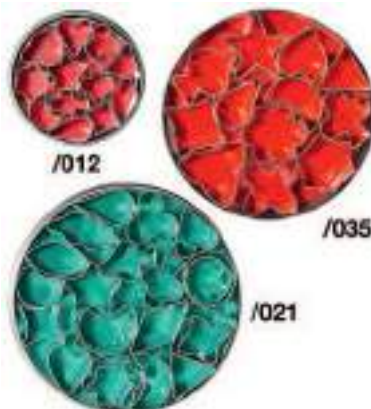

Art-Nr. Part No.	Größe Size mm	Höhe Height mm
---------------------	---------------------	----------------------

Set à 12 Stück sortiert: / Set with 12 assorted pieces:

612/012	16 - 22	20
612/035	30 - 40	20

Set à 21 Stück sortiert: / Set with 21 assorted pieces:

612/021	25 - 35	20
---------	---------	----



Art-Nr. Part No.	Länge Length cm	Höhe Height cm
641/010	3 - 18	2,5



Ausstecher 'Pyramidenbaum'

aus Weißblech, Satz aus zehn Ausstechern in einer Dose (Ø 20 cm), mit diesen kann ein Pyramiden-Weihnachtsbaum geformt werden

Star Cutters

tin plated, set of 10 cutters complete with 20 cm Ø tin, use set to create a beautiful 3D Christmas tree



Art-Nr. Part No.	Länge Length cm	Höhe Height cm	Breite Width cm
635/003	6 / 8,5 / 9	2	3,5 / 4,5 / 6,5



Ausstechformen 'Tannenbaum'

aus Weißblech, drei Stück in einer Dose (Ø 10 cm)

Christmas Tree Cutters

tin plated, three piece set complete with 10 cm Ø tin



Art-Nr. Part No.	Länge Length cm	Höhe Height cm
634/005	5 - 8	2,5



Ausstechformen 'Weihnachten'

aus Weißblech, fünf Stück in einer Dose (28,5 x 7 cm), Motive: Engel, Herz, Tannenbaum, Stern und Glocke

Christmas Cutters

tin plated, 5 piece set complete with 28.5 x 7 cm tin, shapes: angel, heart, christmas tree, star and bell



Art-Nr. Part No.	Länge Length cm	Breite Width cm	Höhe Height cm
642/001	Glocke/Bell	7,5	6,5
642/002	Bär/Bear	9	8,5
642/003	Stiefel/Boots	5,5	7,5
642/004	Mann/Man	8,5	7
642/005	Pferd/Horse	5,5	4



Ausstecher, 'Weihnachten'

aus Weißblech, einzeln

Christmas Cutters

tin plated



Art-Nr. Part No.	Größe Size cm	Höhe Height cm
638/026	6 x 4	2,5



Ausstecher 'Buchstaben', groß

Satz aus 26 Buchstaben von A bis Z, aus Weißblech, im Karton

Alphabet Cutters

tin plated, 26 large letters set, boxed



Art-Nr. Part No.	Größe Size cm	Höhe Height cm
637/060	6,5 x 5	2,5

Lieferung von insgesamt 9 Stück. Die Ziffern 6 und 9 werden durch eine Form abgedeckt.

Number 6 doubles up as number 9.



Ausstecher 'Zahlen', groß

Satz aus Ziffern von 0-9, aus Weißblech, im Karton

Number Cutters

tin plated, 9 large numbers set, boxed



Ausstecher Zweieck

aus hellem Polyamid, temperaturbeständig bis +160°C,
7 Teile in einer Aufbewahrungsdose

Oval Plain Cutters

polyamide, withstand temperatures up to +160°C,
7 piece set, complete with box



Art-Nr. Part No.	Größe Size mm	Höhe Height mm
1226/007	20 x 10 - 110 x 65	35

PA
POLYAMIDE

Ausstecher Mond

aus hellem Polyamid, temperaturbeständig bis +160°C,
7 Teile in einer Aufbewahrungsdose

Moon Shaped Plain Cutters

polyamide, withstand temperatures up to +160°C,
7 piece set, complete with box



Art-Nr. Part No.	Größe Size mm	Höhe Height mm
1227/007	70 x 20 - 120 x 70	35

PA
POLYAMIDE

Ausstecher Schneeflocke

aus hellem Polyamid, temperaturbeständig bis +160°C,
7 Teile in einer Aufbewahrungsdose

Snowflake Cutter

polyamide, withstand temperatures up to +160°C,
7 piece set, complete with box



Art-Nr. Part No.	∅ dia. mm	Höhe Height mm
1224/007	40 - 130	35

PA
POLYAMIDE

Ausstecher Stern

aus hellem Polyamid, temperaturbeständig bis +160°C,
5 Teile in einer Aufbewahrungsdose

Star Cutters

polyamide, withstand temperatures up to +160°C,
5 piece set, complete with box



Art-Nr. Part No.	∅ dia. mm	Höhe Height mm
1225/005	22 - 120	35

PA
POLYAMIDE

Ausstecher Herz

aus hellem Polyamid, temperaturbeständig bis +160°C,
7 Teile in einer Aufbewahrungsdose

Heart Cutters

polyamide, withstand temperatures up to +160°C,
7 piece set, complete with box



Art-Nr. Part No.	Größe Size mm	Höhe Height mm
1228/007	22 x 18 - 110 x 95	35

PA
POLYAMIDE

Ausstecher Tropfen

aus hellem Polyamid, temperaturbeständig bis +160°C,
8 Teile in einer Aufbewahrungsdose

Rain / Tear Drop Cutters

polyamide, withstand temperatures up to +160°C,
8 piece set, complete with box



Art-Nr. Part No.	Größe Size mm	Höhe Height mm
1229/008	15 x 22 - 90 x 120	35

PA
POLYAMIDE

Art-Nr. Part No.	∅ max. cm	Höhe Height cm
228/008	10	3



Ausstecher, rund, glatt

aus weißem Exoglass®, hitzeresistent bis +160°C,
8 Ausstecher von 3 bis 10 cm,
in einer Aufbewahrungsdose, bruchfest

Round Plain Cutters

white Exoglass®, 8 piece set from 3 to 10 cm,
heat resistant up to +160°C, virtually unbreakable



Art-Nr. Part No.	∅ max. cm	Höhe Height cm
230/009	10	3



Ausstecher, rund, gewellt

aus weißem Exoglass®, hitzeresistent bis +160°C,
9 Ausstecher von 2 bis 10 cm,
in einer Aufbewahrungsdose, bruchfest

Round Fluted Cutters

white Exoglass®, 9 piece set from 2 to 10 cm,
heat resistant up to 160°C, virtually unbreakable



Art-Nr. Part No.	∅ dia. cm	Höhe Height cm
4073/012	2,5 - 10,5	5



Ausstecher, rund, glatt

12-teilig, aus Edelstahl

Round Plain Cutters

12 piece set, stainless steel



Art-Nr. Part No.	∅ dia. cm	Höhe Height cm
4074/012	2,5 - 10,5	5



Ausstecher, rund, gewellt

12-teilig, aus Edelstahl

Round Fluted Cutters

12 piece set, stainless steel



Art-Nr. Part No.	∅ außen ∅ Outside cm	∅ innen ∅ Inside cm	Höhe innen Inner Height cm	Höhe gesamt Overall Height cm
683/080	8	4	2	5



Donut-Ausstecher

aus Edelstahl 18/10

Doughnut Cutter

18/10 stainless steel



Art-Nr. Part No.	Länge gesamt Total Length cm	Walzenlänge Cutting Length cm	∅ dia. cm
760/350	47	21	9,5



Croissant-Schneider

Dreieck-Ausstechrolle, aus Edelstahl 18/10,
mit hellen Kunststoffgriffen, kleine Klingen schneiden
die Grundlinie ein und ermöglichen so die Vergrößerung
des Volumens beim Backen

Croissant Cutter

18/10 stainless steel, with plastic handles





Konfiserie & Schokolade

Schokolade macht glücklich und Pralinen versüßen das Leben. Mit dem richtigen Werkzeug gelingt das mühelos. Konfiseure und Chocolatiers werden hier fündig.

Chocolate & Confectionery

This is where chocolatiers and confectioners will find what they are looking for.

Couvertüre-Temperiergerät

fest fixierte Schale aus Edelstahl 18/10, hochglänzend, Außenkorpus aus robustem Polycarbonat, regulierbar zwischen +25°C und +90°C, 230 V, 200 W, energiesparend durch verstärkte Isolierung

Chocolate/Sauce Warmer

with 18/10 stainless steel bowl, mirror polished, firmly fixed inside, robust polycarbonate body, adjustable between +25°C and +90°C, 230V ac/200 W, economic due to reinforced insulation



18/10
EDELSTAHL
STAINLESS STEEL

PC
POLY-
CARBONATE

Art-Nr. Part No.		∅ oben ∅ Top cm	Höhe außen Outer Height cm
498/240	3,5 l	25,5	19

Wasserbadschüssel

aus Edelstahl 18/10, hochglänzend, mit Drahtgriff und Schüttrand, schwere Qualität

Bailing Bowl

bain marie bailing bowl, scoop 18/10 stainless steel, mirror polished, with wire handle



18/10
EDELSTAHL
STAINLESS STEEL

Art-Nr. Part No.	∅ innen ∅ Inside cm	Höhe Height cm	Stiellänge Handle Length cm	
Für Töpfe von ∅ 20 bis 26 cm: / For pots ∅ 20 to 26 cm:				
2060/180	18	9	20	1,5 l
Für Töpfe von ∅ 24 bis 28 cm: / For pots ∅ 24 to 28 cm:				
2060/200	20	10	20	2 l
Für Töpfe von ∅ 26 bis 28 cm: / For pots ∅ 26 to 28 cm:				
2060/240	24	12	20	3,5 l

Schokoladenspachtel

aus flexiblem Edelstahl 18/0, 0,5 mm Materialstärke, Kunststoffgriff mit Aufhängeöse, insbesondere zum Abziehen von Schokoladen

Chocolate Spatula

flexible 18/0 stainless steel, 0.5 mm material gauge, plastic handle with hanging loop, especially for smoothing chocolate



18/0
EDELSTAHL
STAINLESS STEEL

PVC
KUNSTSTOFF
PLASTIC

Art-Nr. Part No.	Spatelmaß Blade cm	Stiellänge Handle Length cm
4079/180	18 x 9,5	12

Trüffel-/Pralinengitter

aus Edelstahl 18/10, elektropoliert, Rahmendraht ∅ 6 mm, Gitterdraht ∅ 1 mm, Maschenweite 4,5 mm, schwere Qualität

Chocolate/ Truffle Rack

18/10 stainless steel, electro-polished, frame wire: ∅ 6 mm, mesh wire: ∅ 1 mm, mesh size: 4.5 mm, heavy gauge

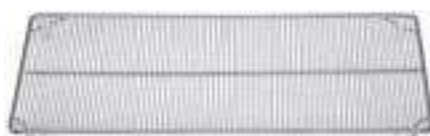

18/10
EDELSTAHL
STAINLESS STEEL

Art-Nr. Part No.	Länge Length cm	Breite Width cm	Höhe Height cm
3440/590	59	39	2,5

Passend in Ablaufkasten 4718/600 auf Seite [4718].
Matches rectangular tray 4718/600 on page [4718].



Art-Nr. Part No.	∅ dia. mm	Länge Length mm	Breite Width mm	Höhe Height mm	Anzahl Formen Moulds
Überzug: / Log:					
6751/001		20	31	17	21
Muschel: / Shell:					
6751/002		32	42	19	18
Schneckenhaus: / Snail shell:					
6751/003		28	35	21	24
Diamant: / Diamond:					
6751/004	25			17	21
Kegelstumpf: / Cone:					
6751/005	23			16	21
Kleeblatt: / Clover:					
6751/006	27			14	24
Halbkugel: / Half Ball:					
6751/007	27			14	32
Blatt: / Leaf:					
6751/008		57	34	5	14
Herz: / Heart:					
6751/009	22	27	15		21
Erdbeere: / Strawberry:					
6751/010	30	27	18		32
Rechteck mit Furchenmuster: / Bar with furrow pattern:					
6751/011	21	18	13		24
Oval mit Linie: / Oval with Line:					
6751/012	32	21	14		24
Halbkugel: / Half bowl:					
6751/013	20		10		36
Pyramide: / Pyramid:					
6751/014	25	25	19		21
Barren: / Bar:					
6751/015	33	19	17		30
Ovaler Kegel: / Oval Cone:					
6751/016	35	25	19		24
Quadrat: / Square:					
6751/017	21	21	18		36
Krone: / Crown:					
6751/018	27	22	15		24
Ronde: / Circle:					
6751/019	55		5		8
Glatter Kegel: / Plain Cone:					
6751/020	28		17		21



Pralinenform

27,5 x 13,5 x 2,5 cm große Formplatten aus Polycarbonat zur Herstellung von Pralinen

Chocolate Moulds

27.5 x 13.5 x 2.5 cm polycarbonate sheets for making chocolates



Art-Nr. Part No.	Größe Size cm	Länge gesamt Total Length cm
Spirale: / Spiral Fork:		
499/001	2,4	21
Gabel mit zwei Zinken: / Fork 2 Pronged:		
499/002	1	21
Gabel mit drei Zinken: / Fork 3 Pronged:		
499/003	1,8	21
Gabel mit vier Zinken: / Fork 4 Pronged:		
499/004	2,4	21
Oval: / Oval Fork:		
499/005	1,8	21
Dreieck: / Triangular Fork:		
499/006	2,4	21
Rund Ø 14 mm: / Round Ø 14 mm Fork:		
499/014	1,4	21
Rund Ø 16 mm: / Round Ø 16 mm Fork:		
499/016	1,6	21
Rund Ø 20 mm: / Round Ø 20 mm Fork:		
499/020	2	21

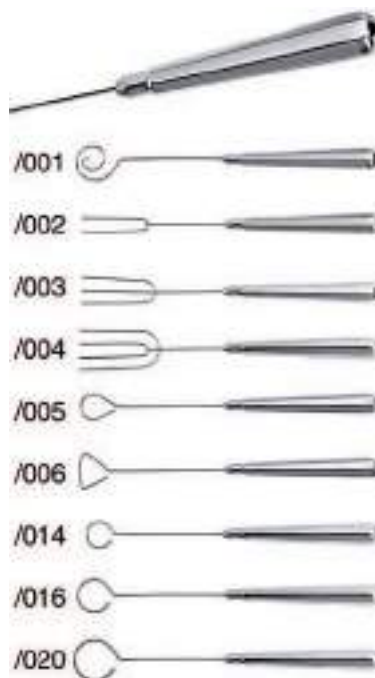

Pralinen-Tungabeln

ganz aus Edelstahl 18/10, hochglänzend, mit handlichem Hohlgriff, spülmaschineneignend, hochqualitative Ausführung

Dipping Forks

18/10 stainless steel, mirror polished finish, with comfortable hollow handle, dishwasher proof, top quality



Dekorierlöffel

aus Edelstahl 18/10, einfache Dekoration auf Platten und Tellern mit Saucen, Crèmes oder Coulis

Decorating Spoon

18/10 stainless steel, for easy decoration of dishes and plates with sauces and coulis



Art-Nr. Part No.	Länge Length cm	
1278/190	19	10 ml

Dekorierlöffel, kurz

aus Edelstahl 18/10, einfache Dekoration auf Platten und Tellern mit Saucen, Crèmes oder Coulis

Decorating Spoon

18/10 stainless steel, short handle, for easy decoration of dishes and plates with sauces and coulis



Art-Nr. Part No.	Länge Length cm	Breite Width cm	
1279/110	11	4	12 ml

Fondant-Ausstecher STERNFRUCHT

Set aus 3 Größen, aus weißem Polypropylen

Fondant Cutter STARFRUIT

set of 3 sizes, white polypropylene



Art-Nr. Part No.	∅ dia.
6740/042	3 cm / 4,2 cm / 5 cm

Fondant-Ausstecher ROSENBLATT

Set aus 3 Größen, aus weißem Polypropylen, mit Auswerfer

Fondant Cutter ROSE LEAF

set of 3 sizes, white polypropylene, with pusher



Art-Nr. Part No.	Länge Length
6741/040	3,3 cm / 4 cm / 4,8 cm
6741/060	5,7 cm / 6 cm / 6,5 cm

Fondant-Ausstecher GLATTES BLATT

Set mit 2 verschiedenen Blattformen, aus weißem Polypropylen, mit Auswerfer

Fondant Cutter LEAVE

set of two different shapes, white polypropylene, with pusher



Art-Nr. Part No.	Länge Length cm	Breite Width cm	Höhe Height cm
6742/068	6,8	4	5,5

Schokoladenhobel

aus hochdichtem grob schwarz-weiß marmorierten Polyethylen, Hobel ganz aus Edelstahl 18/0, ergonomischer Drehgriff, spülmaschinenfest, zum dekorativen Schaben von Choco Rolles-Schokolade

Choco Rolles Shaver

high density polyethylene, with stainless steel blade, easy to use turning handle, dishwasher safe, for shaving chocolate



Art-Nr. Part No.	∅ dia. cm	Höhe Height cm
3666/220	22	16

Passende Abdeckhaube aus klarem Polystyrol von Seite 303 (hierfür ohne Griffknopf zu verwenden); / Clear polystyrene cover see page 303 (use without knob herefore):
3689/200



Art-Nr. Part No.	∅ dia. cm	Höhe Height cm
458/180	1,5 l	18
458/230*	2 l	23

Ersatzschraube mit 4 mm Durchlass / spare 4 mm nozzle
458/904

Ersatzschraube mit 6 mm Durchlass / Spare 6 mm nozzle
458/906

* mit Gegengriff

* with extra handle



Fondant-/Likörtrichter

ganz aus Edelstahl 18/10, seidenmatt, tropfdicht, mit Einhandmechanik, Ablassöffnung wahlweise 4, 6 oder 8 mm Durchmesser (durch Entfernen der Ablassschraube), sehr hygienisch, mühelose Reinigung durch leichte Demontage, hochqualitatives stabiles Produkt mit geringem Eigengewicht

Fondant Funnel

18/10 stainless steel, satin polished finish, with 4 mm (liqueur) & 6 or 8 mm (fondant) nozzle, easily dismantled for cleaning



Art-Nr. Part No.	∅ oben ∅ Top cm	Höhe Height cm
459/001	1,5 l	15



Fondantrichter-Halter

aus Edelstahl 18/10, seidenmatt poliert

Holder for Fondant Funnel

18/10 stainless steel, satin polished finish



Art-Nr. Part No.	∅ innen ∅ Inside cm	Höhe Height cm
460/001	9	16



Fondantrichter-Halter

Draht aus Edelstahl

Fondant Funnel/Chinois Stand

stainless steel wire



Art-Nr. Part No.	∅ dia. cm	Höhe Height cm
1170/180	18 cm	28 cm



Ständer

für Siebe und Fondantrichter, aus Edelstahl 18/0, elektropoliert, stabile Qualität, geeignet für alle Größen von Spitz- und Gazesieben sowie Fondantrichtern

Stand for Chinois and Fondant Funnels

18/0 stainless steel, electro-polished, for all sizes of our chinois and fondant funnels, sturdy quality



Art-Nr. Part No.	∅ dia. cm	Höhe Height cm
4480/130	1,35 l	13



Fondantrichter

aus Edelstahl, einfache Ausführung, Durchlauföffnung 8 mm, mit Ständer

Fondant Funnel

stainless steel, economy, 8 mm nozzle, with stand



Konditorei

Erste Sahne, diese Torten auf Trägern von **contacto**. Von diesen Kunstwerken können Sie sich ein Stück abschneiden. Tortenplatten, Heber und Hauben für Omas Landkuchen oder die Sachertorte.

Cake Stands & Knives

Enhance your cake presentation beautifully with our stunning stands.

Tortenplatte

aus Edelstahl 18/10, seidenmatt poliert, der geschlossene Fuß ist vollständig mit dem Rand der Auflageplatte verkapselt, schwere Qualität

Cake Stand

18/10 stainless steel, satin polished finish, foot is enclosed, heavy gauge



Art-Nr. Part No.	∅ dia.	Höhe Height
777/300	30 cm	3,5 cm
777/320	32 cm	3,5 cm

Hierzu passende Tortenhaube 650, 644 und 643 auf Seite 276.
Takes plastic cover 650, 644 and 643 (page 276).

Tortenplatte

mit flachem breiten Fuß, aus Edelstahl, seidenmatt poliert

Cake Stand

stainless steel, with short wide foot, satin polished finish



Art-Nr. Part No.	∅ dia.	Höhe Height
778/300	30 cm	2 cm
779/300	30 cm	5,5 cm

Hierzu passende Tortenhauben 644 und 650 auf Seite 276.
Takes plastic covers 644 and 650 (page 276).

Tortenplatte / Petits-Fours Ständer

mit hohem Fuß, aus Edelstahl 18/10, seidenmatt, schwere Qualität

Cake Stand

with tall foot, 18/10 stainless steel, satin polished finish, heavy gauge



Art-Nr. Part No.	∅ dia.	Höhe Height
Petits-Fours-Ständer: / Cake Stand:		
775/200	19,5 cm	11 cm
Tortenplatte: / Cake Stand:		
775/250	24 cm	11 cm
Tortenplatte: / Cake Stand:		
771/300*	29,5 cm	11 cm

*Lieferung unmontiert.
*Supplied flat packed.

Tortenplatte, drehbar

aus Edelstahl 18/10, mit hohem Fuß, seidenmatt gebürstet, Außenkante offen gebördelt, mit drehbarer Bodenplatte, hochwertige Verarbeitung, schwere Qualität

Revolving Cake Stand

with tall foot, 18/10 stainless steel, satin polished finish, heavy gauge



Art-Nr. Part No.	∅ dia.	Höhe Height
788/300	30 cm	13,5 cm

Hierzu passende Tortenhaube 650 auf Seite 276.
Takes plastic cover 650 (page 276).

Art-Nr. Part No.	∅ dia.	Höhe Height
773/320	30 cm	7,5 cm
773/330	32 cm	7,5 cm

Hierzu passende Tortenhaube 643, 644 und 650 auf Seite 276.
Takes 643, 644 and 650 plastic covers (page 276).



Tortenplatte, drehbar
aus Edelstahl 18/10, seidenmatt poliert

Revolving Cake Stand
18/10 stainless steel, satin polished



Art-Nr. Part No.	∅ dia.	Höhe Height
787/300	30 cm	7 cm



Tortenplatte, drehbar
Glasplatte, auf drehbarem Edelstahlfuß

Revolving Cake Stand
glass plate, on rotating stainless steel foot



Art-Nr. Part No.	∅ dia.
630/300*	30 cm

Leichte (0,4 mm) Ausführung: / Light weight (0.4 mm):
630/300* 30 cm

Mittelschwere (0,7 mm) Ausführung: / Medium (0.7 mm) weight:
633/300* 30 cm
633/330** 33 cm

*hierzu passende Tortenhaube 650/300 und 643/300.
**hierzu passende Tortenhauben 644/330 und 650/330.

*Takes 650/330 and 643/300 plastic cover.

**Takes 644/330 and 650/330 plastic covers.



Tortenplatte
aus Edelstahl 18/0, hochglänzend, mit zwei Griffen

Cake Tray
18/0 stainless steel, mirror polished finish, two handles



Art-Nr. Part No.	∅ cm	Höhe Height cm
3236/003	20 / 26 / 32	39

Lieferung unmontiert. Erweiterung bis zu 5 Etagen auf Anfrage möglich.

Supplied flat packed. Can be increased up to 5 tiers on request.



Etagen-Tortenständer
Hochzeitstortenständer, Scheiben und Zwischenstücke aus Edelstahl 18/10, 16 cm Abstand zwischen den Ebenen, stabile Ausführung

3 Tier Wedding Cake Stand
18/10 stainless steel, 16 cm distance between the layers, heavy gauge



Tortenplatte mit Haube

aus Edelstahl 18/0, mit Haube aus klarem Polystyrol, für Kuchen bis 28 cm

Cake Tray with Cover

18/0 stainless steel, with clear polystyrene cover, for cakes up to 28 cm



Art-Nr. Part No.	∅ dia. cm	Höhe innen Inner Height cm
679/300	30	7

Platte mit Haube

Platte aus Edelstahl 18/0, hochglänzend, Haube aus Luran®, temperaturresistent zwischen -40°C und +95°C, als Tortenplatte geeignet

Cake Tray with Cover

18/0 stainless steel tray, mirror polished finish, with Luran® cover, can be used between -40°C and +95°C



Art-Nr. Part No.	∅ außen ∅ Outside cm	∅ innen ∅ Inside cm	Höhe Height cm
672/380	38	30	9,5

Ersatzhaube siehe Art. 644/300.
Spare cover: 644/300.

Tortenhaube, hoch

aus hart-elastischem Polystyrol, geeignet für Mikrowelle und Gefriertruhe, einsetzbar von -40°C bis +95°C, hohe Form

High Cake Cover

clear polystyrene, suitable for microwave ovens and freezers (-40°C to +95°C)



Art-Nr. Part No.	∅ innen ∅ Inside cm	∅ Teller ∅ Plate cm	Höhe innen Inner Height cm	Höhe außen Outer Height cm
644/300*	29,5	30	8	9,5
644/330**	31,5	33	11,5	12,5
644/420***	42	41,5	11	14

*passend zu Tortenplatten 773, 777, 778, 779

**passend zu Tortenplatte 633/330

***Für Original Landkuchen geeignet. Passend zu Tortenscheibe 693/400 von Seite 245.

*Fits cake stands 773, 777, 778, 779

**Fits cake tray 633/330

***For large 40 cm cakes. Fits cake base 693/400- see page 245.

Tortenhaube

aus weich-elastischem Polypropylen, bruchfest, geeignet für Mikrowelle, Spülmaschine und Gefriertruhe, einsetzbar von -20°C bis +120°C, hohe Form, stapelbar

Cake Cover

opaque polypropylene, virtually unbreakable, stackable, dishwasher proof, suitable for microwave ovens and freezers (-20°C to +120°C)



Art-Nr. Part No.	∅ dia. cm	Höhe Height cm
650/300*	30	11
650/330**	33	14

*passend zu Tortenplatten 630, 633, 773, 777, 778, 779

**passend zu Tortenplatten 633/330

*Fits cake trays and stands 630, 633, 773, 777, 778, 779

**Fits cake trays and stands 633/330

Tortenhaube, flach

aus hartem elastischen Polystyrol, geeignet für Mikrowelle und Gefriertruhe, einsetzbar von -40°C bis +95°C

Cake Cover

clear polystyrene, dishwasher, microwave and freezer safe (-40°C to +95°C)



Art-Nr. Part No.	∅ dia. cm	Höhe Height cm
643/300	29,5	7

Tortenträger

aus Polystyrol, der Einsatz aus Polypropylen mit Hehebügel ermöglicht das leichte Entnehmen, für Torten bis ∅ 31,5 cm und 10 cm Höhe geeignet

Cake Container

polystyrene, with polypropylene insert, which enables the easy removal of cakes up to 31.5 cm dia. and 10 cm deep



Art-Nr. Part No.	∅ außen ∅ Outside cm	Höhe außen Outer Height cm
---------------------	----------------------------	----------------------------------

PRODUKTION
EINGESTELLT
PRODUCTION
DISCONTINUED

Art-Nr. Part No.	Spatelmaß Blade cm	Länge gesamt Total Length cm
27/220	11 x 5,5	22



Tortenheber

aus Edelstahl 18/10, hochglänzend, fugenlos, schwere Qualität

Cake/Pie Lifter

18/10 stainless steel, mirror polished finish



Art-Nr. Part No.	Spatelmaß Blade cm	Länge gesamt Total Length cm
3366/230	11,5 x 6	23,5



Tortenheber

Serie BUFFET ONE, aus Edelstahl 18/10, fugenlos, hochglänzend polierte Schaufel, seidenmatt polierter, angewinkelter Stiel, Griff bleibt aufrecht stehen

Pastry Server

BUFFET ONE range, 18/10 stainless steel, one piece, mirror polished, satin polished angled handle



Art-Nr. Part No.	Spatelmaß Blade cm	Länge gesamt Total Length cm
3366/290	17 x 6,5	29

speziell für 40 cm Landkuchen (bis 16 Stücke)
especially for large cakes of 40 cm cut into 16 pieces

Art-Nr. Part No.	Spatelmaß Blade cm	Länge gesamt Total Length cm
1999/059	11 x 4,5	22



Tortenheber

aus Edelstahl 18/10, hochglänzend, fugenlos

Cake/Pie Lifter

18/10 stainless steel, mirror polished finish



Art-Nr. Part No.	Spatelmaß Blade cm	Länge gesamt Total Length cm
1666/059	12 x 5,5	24



Tortenheber

aus Edelstahl 18/10, hochglänzend, fugenlos, mittelschwere Qualität

Cake/Pie Lifter

18/10 stainless steel, mirror polished finish, one piece



Art-Nr. Part No.	Spatelmaß Blade cm	Länge gesamt Total Length cm
4068/275	14 x 6	27,5



Tortenheber

aus Edelstahl matt poliert, mit Griff aus weißem Polypropylen

Cake/Pie Lifter

stainless steel blade, matt polished finish, with white polypropylene handle



Art-Nr. Part No.	Spatelmaß Blade cm	Länge gesamt Total Length cm
996/270	12 x 6	27



Tortenheber

Serie POLARIS, mit seidenmatt poliertem Griff aus Edelstahl 18/10, mit Aufhängeöse, angewinkelter Spatel aus hochglänzendem Edelstahl 18/8

Cake/Pie Lifter

handle 18/10 stainless steel, satin polished, with hanging loop, blade 18/8 stainless steel, mirror polished, cranked



Art-Nr. Part No.	Spatelmaß Blade cm	Länge gesamt Total Length cm
7793/280	14 x 5,5	28



Tortenheber mit Messer

Serie ERGONOM, aus 1,6 mm starkem Edelstahl 18/0, mit einer Schnittkante, hochglänzend, ergonomisch profilierter Griff aus Edelstahl 18/10, fugenlos, schwere Qualität

Cake/Pie Lifter

1.6 mm thick 18/0 stainless steel, mirror polished finish, 18/10 stainless steel ergonomically designed handle, heavy gauge



Tortenheber

Serie BUFFET NOIR, mit Griff aus schwarzem ABS, Arbeitsteil aus Edelstahl, temperaturbeständig bis +120°C, spülmaschinengeeignet

Cake Lifter

BUFFET NOIR range, stainless steel, with black ABS handle, heat resistant up to +120°C, dishwasher safe



Art-Nr. Part No.	Spatelmaß Blade cm	Länge gesamt Total Length cm
8953/320	7 x 12	33

Blechkuchenheber

aus Edelstahl 18/0, mit Griff aus glasfaserverstärktem Polyamid, spülmaschinenfest, speziell für Selbstbedienung, verhindert das gleichzeitige Anheben mehrerer Kuchenstücke

Cake Lifter

18/0 stainless steel, fibreglass reinforced polyamide handle, dishwasher safe, especially useful for ensuring that only one piece of cake is lifted



Art-Nr. Part No.	Spatelmaß Blade cm	Länge gesamt Total Length cm
4053/200	6,5 x 6,5	23

Tortenheber mit Messer

Serie POLARIS, mit seidenmatt poliertem Griff aus Edelstahl 18/10, mit Aufhängeöse, angewinkelter Spatel aus hochglänzendem Edelstahl 18/10, mit einer gezahnten Kante

Cake/Pie Knife/Lifter

handle 18/10 stainless steel, satin polished, with hanging loop, blade 18/10 stainless steel, mirror polished, cranked, one edge serrated



Art-Nr. Part No.	Spatelmaß Blade cm	Länge gesamt Total Length cm
905/255	13,5 x 5	25,5

Tortenheber, gezahnt

Serie POLARIS, mit seidenmatt poliertem Griff aus Edelstahl 18/10, mit Aufhängeöse, leicht gekröpfter Heber aus hochglänzendem Edelstahl 18/10, mit einer gezahnten Kante

Cake/Pie Lifter

with hanging loop, handle 18/10 stainless steel, blade 18/10 stainless steel, one edge serrated, slightly cranked



Art-Nr. Part No.	Spatelmaß Blade cm	Länge gesamt Total Length cm
937/255	10 x 5,5	26

Tortenteiler

aus cremefarbenem Polypropylen, beidseitig verwendbar, mit zwei Griffflaschen, hitzeresistent bis +125°C

Flan Divider

cream polypropylene, reverse for other portion size, two handles, heat resistant up to +125°C



Art-Nr. Part No.	Höhe Height cm	Ø dia. cm	Segmente Portions
695/004	2,5	26,5	8 / 12
695/001	2,5	26,5	12 / 16
695/002	2,5	26,5	12 / 18
695/003	2,5	26,5	14 / 16

Tortenteiler

aus Edelstahl 18/10, hochglänzend

Flan Divider

18/10 stainless steel, mirror polished finish



Art-Nr. Part No.	Höhe Height cm	Ø dia. cm	Segmente Portions
696/010	3,5	32	10
696/012	3,5	32	12
696/014	3,5	32	14
696/016	3,5	32	16
696/018	3,5	32	18

Art-Nr. Part No.	Klingenlänge Blade cm	Klingenlänge Blade Zoll	Länge gesamt Total Length cm
7792/280	15,5	6"	28



Tortenmesser

Serie ERGONOM, aus Edelstahl 18/0, hochglänzend, ergonomisch profilierter Griff aus Edelstahl 18/0, fugenlos, eine Kante gezahnt, durch extrabreite Klinge auch als Kuchenheber zu verwenden

Cake Slice

18/10 stainless steel handle, ergonomically designed, 18/0 stainless steel blade, mirror polished finish, one edge serrated



Art-Nr. Part No.	Klingenlänge Blade cm	Klingenlänge Blade Length Zoll	Länge gesamt Total Length cm
28/170	17	7"	29



Tortenmesser

mit ABS-Griff, zweischneidig, eine Seite mit Säge, 5 cm breite Klinge

Cake Knife

with ABS handle, double-edged, one edge serrated, blade width 5 cm



Art-Nr. Part No.	Klingenlänge Blade cm	Klingenlänge Blade Zoll	Länge gesamt Total Length cm
7783/300	18	7"	30



Kuchenmesser

Serie ERGONOM, mit Wellenschliff, aus Edelstahl 18/0, hochglänzend, ergonomisch profilierter Griff aus Edelstahl 18/10, fugenlos, durch extrabreite Klinge auch als Kuchenheber zu verwenden

Cake Knife

18/10 stainless steel handle, ergonomically designed, 18/0 stainless steel blade with wavy edge, mirror polished finish



Art-Nr. Part No.	Klingenlänge Blade Length cm	Klingenlänge Blade Length Zoll	Klingenbreite Blade Width cm
3719/300	30	12"	2,2



Konditormesser

mit glatter Klinge, aus Chrom-Molybdän-Vanadium (DIN x50CrMoV15), Griff aus schwarzem ABS-Kunststoff, spülmaschinengeeignet

Confectioners Knife

with plain edge, molybdenum vanadium stainless steel, with black ABS handle, dishwasher safe



Art-Nr. Part No.	Klingenlänge Blade cm	Klingenlänge Blade Zoll	Klingenbreite Blade Width cm
3722/305	30,5	12"	3,6



Bäckermesser

mit einseitigem Wellenschliff, aus Chrom-Molybdän-Vanadium (DIN x50CrMoV15), Griff aus schwarzem ABS-Kunststoff, spülmaschinengeeignet

Bakers Knife

with scalloped edge, molybdenum vanadium stainless steel, with black ABS handle, dishwasher safe



Messerabstreichbehälter

mit Aufsatz, aus Edelstahl 18/10, hochglänzend poliert, schwere Qualität, Abstreichbacken aus Gummi in Lebensmittelqualität (hitzebeständig bis +80°C), Bodeneinlage aus POM zum Schonen der Messerspitzen

Knife Cleaner

18/10 stainless steel, mirror polished finish, with top insert from rubber for temperatures up to +80°C, POM insert to protect the knife blades



Art-Nr. Part No.	Höhe gesamt Overall Height cm	Ø dia. cm
305/100	1,5 l	20
305/300	2,3 l	30

305/905	Ersatz-Abstreifgummi / spare rubber top	
305/909	Ersatzbodenscheibe / Spare bottom insert	

Messerabstreichbehälter, einbaufähig

aus Edelstahl 18/10, dreiteilig für Thekeneinbau mit Einbauzylinder, Innenbehälter und Spezialaufsatz, hochglänzend poliert, Lochausschnitt mind. 104 mm, schwere Qualität, Abstreichbacken aus Gummi in Lebensmittelqualität (hitzebeständig bis +80°C), Bodeneinlage aus POM zum Schonen der Messerspitzen

Knife Cleaner

outer cylinder fits into cut-out in worktops, the inner cylinder with lid is removable, 18/10 stainless steel, with top insert from rubber for temperatures up to +80°C, POM insert to protect the knife blades



Art-Nr. Part No.	Höhe gesamt Overall Height cm	Ø außen Ø Outside cm	Ø oben Ø Top cm
306/200	1,5 l	20	10,4

305/905	Ersatz-Abstreifgummi / spare rubber top	
305/909	Ersatzbodenscheibe / Spare bottom insert	

Messerabstreichbehälter, einbaufähig

aus Edelstahl 18/10, mit Wasseranschluss bestehend aus Einlaufkopf 1/2" und Ablaufstandrohr mit Schlauchverschraubung 1/2", einfacher Zylinder, Deckel mit Abstreichgummi wie Modell 306 Lochausschnitt mind. 103 mm

Knife Cleaner

18/10 stainless steel cylinder, with top rubber inserts similar to model 306, water connection with 1/2" inlet and outlet tube with 1/2" screwed hose connection, heavy gauge, fits into cut-outs with at least 103mm diameter



Art-Nr. Part No.	Höhe gesamt Overall Height cm	Ø außen Ø Outside cm	Ø oben Ø Top cm
307/200	1,5 l	20	10,4

305/905	Ersatz-Abstreifgummi / spare rubber top	
---------	---	--



Eiscafé

Gelateria classica. Hier schlägt das Herz jedes Eisliebhabers höher. Coppa di frutta, Cassata, Tartufo, Amaretto, Tiramisù ... die Eissaison kann beginnen!

Ice Cream

Comet, cone or scoop, spoon, tray or mould, everything you need, just make sure it's cold!

Art-Nr. Part No.		∅ dia. cm	Höhe Height cm
4672/105	0,25 l	10,5	8



Eisbecher

aus Edelstahl 18/10, hochglänzend, mit Spülwasserablauf im Fuß, schwere Qualität

Fruit Sundae Cup

18/10 stainless steel, mirror polished finish, heavy gauge



Art-Nr. Part No.		∅ dia. cm	Höhe Height cm
4680/090	0,15 l	9,5	5,5



Eisbecher

aus Edelstahl, hochglänzend, mittelschwere Qualität

Sundae Cup

stainless steel, mirror polished finish



Art-Nr. Part No.		∅ dia. cm	Höhe Height cm
4682/080	0,125 l	8	11
4682/100	0,2 l	10,5	8,5



Eiskelch, hoch

aus Edelstahl 18/10, hochglänzend, mit verstärktem Rand, extra schwere Qualität

Sundae Cup

18/10 stainless steel, mirror polished finish, with reinforced edge, extra heavy gauge



Art-Nr. Part No.		∅ dia. cm	Höhe Height cm
4685/095	0,15 l	9,5	9



Eiskelch

aus Edelstahl 18/0, außen hochglänzend, mittelschwere Qualität

Sundae Cup

18/0 stainless steel, outside mirror polished finish



Eisschale

aus Edelstahl 18/10, hochglänzend, stark abgeflachte Form, extra schwere Qualität

Sundae Dish

18/10 stainless steel, mirror polished finish, heavy gauge



Art-Nr. Part No.	∅ dia. cm	Höhe Height cm
Ohne Griff: / Without handle:		
4678/125	12	2
4678/140	14	2,5
mit Griff: / with handle:		
4677/125	12	2

Untersetzer

aus Edelstahl 18/10, hochglänzend, mit offenem Rand, schwere Qualität

Coaster

18/10 stainless steel, mirror polished finish, open edge, heavy gauge



Art-Nr. Part No.	Höhe Height cm	∅ außen ∅ Outside cm	∅ innen ∅ Inside cm
Für Eiskelche 4680, 4682 auf Seite 281: For Sundae Cups 4680, 4682 on page 281:			
232/120	0,8	12	6,5
Für Eiskelche 4685, 4672: / For Sundae Cups 4685, 4672:			
232/140	1	14	8

Untersetzer

aus Edelstahl 18/10, hochglänzend, glatte Bodenfläche, als Tablett, Eiskelch- oder Flaschenuntersetzer geeignet

Tip Tray/ Coaster

18/10 stainless steel, mirror polished finish, plain base



Art-Nr. Part No.	∅ außen ∅ Outside cm
1415/090	9
1415/110	11
1415/140	14

Eislöffel

Besteckserie LOUISA, aus Edelstahl 18/10, hochglänzend

Sundae Spoon

18/10 stainless steel, mirror polished finish



Art-Nr. Part No.	Länge Length cm
1999/052	13,5

Preis je Stück. Besteck wird nur dutzendweise abgegeben.
Priced each. Only available in dozens.

Eislöffel

Besteckserie LUNA, aus Edelstahl 18/10, hochglänzend

Sundae Spoon

18/10 stainless steel, mirror polished finish



Art-Nr. Part No.	Länge Length cm
1777/052	13

Preis je Stück. Besteck wird nur dutzendweise abgegeben.
Priced each. Only available in dozens.

Eisspatel

aus eloxiertem Aluminium, lebensmittelgeeignet, nicht spülmaschinengeeignet

Mini Ice Cream Spoon

anodised aluminium, food safe, not dishwasher safe



Art-Nr. Part No.	Länge Length cm	Löffelmaß Bowl Size cm	Farbe Colour
1269/100	9,5	3 x 2,5	silber/silver

Preis einzeln. Empfohlene Verpackungseinheit 10 Stück.
Priced each. Recommended pack unit 10 pcs.



Art-Nr. Part No.	Länge Length cm
1777/072	19,5

Preis je Stück. Besteck wird nur dutzendweise abgegeben.
Priced each. Only available in dozens.



Eislöffel, lang

Besteckserie LUNA aus Edelstahl 18/10

Sundae Spoon

18/10 stainless steel



Art-Nr. Part No.	Länge Length cm
1999/072	22

Preis je Stück. Besteck wird nur dutzendweise abgegeben.
Priced each. Only available in dozens.



Eislöffel, lang

Besteckserie LOUISA aus Edelstahl 18/10

Sundae Spoon

18/10 stainless steel



Art-Nr. Part No.	Länge Length cm
1188/072	19,5

Preis je Stück. Besteck wird nur dutzendweise abgegeben.
Priced each. Only available in dozens.



Eislöffel, lang

Besteckserie ATLANTIC aus Edelstahl 18/0

Sundae Spoon

18/0 stainless steel



Art-Nr. Part No.	Länge Length cm
1133/072	19,5

Preis je Stück. Besteck wird nur dutzendweise abgegeben.
Priced each. Only available in dozens.



Eislöffel, lang

Besteckserie EVENT aus Edelstahl 18/0

Sundae Spoon

18/0 stainless steel



Art-Nr. Part No.	Länge Length cm
1122/072	19,5

Preis je Stück. Besteck wird nur dutzendweise abgegeben.
Priced each. Only available in dozens.



Eislöffel, lang

Besteckserie CAMPUS aus Edelstahl 18/0

Sundae Spoon

18/0 stainless steel



Art-Nr. Part No.	Länge Length cm
404/072	19

Preis je Stück. Besteck wird nur dutzendweise abgegeben.
Priced each. Only available in dozens.



Eislöffel, lang

Besteckserie ISABELLA aus Edelstahl 18/0

Sundae Spoon

18/0 stainless steel



Art-Nr. Part No.	Länge Length cm
1273/140	14
1273/190	19

Preis je Stück. Einzelabgabe.
Priced and packed each.



Eis-/ Joghurtlöffel

aus Edelstahl, die besondere elegante Löffelform ermöglicht das Entnehmen des Joghurts o. ä. aus schwer zugänglichen Eckbereichen

Sundae / Yoghurt Spoon

stainless steel



Spiral-Eishörnchenständer

aus Edelstahl 18/10, hochglänzend,
zum Absetzen von Eistüten, stabile Qualität

Cornet Stand

18/10 stainless steel, mirror polished finish



Art-Nr. Part No.	∅ Boden ∅ Base cm	Höhe Height cm
1045/225	10,5	22,5

Eishörnchenständer

aus Edelstahl 18/10, hochglänzend poliert, wahlweise
mit zwei oder drei Löchern, zum Absetzen von Eistüten

Cornet Stand

18/10 stainless steel, mirror polished finish,
with 2 or 3 holes



Art-Nr. Part No.	Länge Length cm	Breite Width cm	Höhe Height cm
---------------------	-----------------------	-----------------------	----------------------

Mit zwei Löchern (33 mm): / With 2 holes (33 mm):

1144/002	13,5	7	8,5
----------	------	---	-----

Mit drei Löchern (27 mm, 33 mm, 27 mm): / With 3 holes (27 mm, 33 mm, 27 mm):

1144/003	21	7	8,5
----------	----	---	-----

Eishörnchenständer

aus Edelstahl 18/10, hochglänzend, mit je zwei Löchern
von 27 und 35 mm Durchmesser, auch für die meisten
handelsüblichen Vorratsständer geeignet

Cornet Stand

18/10 stainless steel, mirror polished finish,
with two 27 mm holes and two 35 mm holes



Art-Nr. Part No.	Länge Length cm	Breite Width cm	Höhe Height cm
1145/004	12	12	7,5

Malerpalette

aus Edelstahl 18/10, mit Griffloch zum Tragen oder
Servieren von Eishörnchen, Mini-Eishörnchen oder
Mini-Wraps, mit drei angeschraubten Gummifüßen,
die Füße können durch Hochsteller ersetzt werden,

Cornet Stand

18/10 stainless steel, with large hole, three short rubber
feet, can be replaced with taller feed, for ice cream



Art-Nr. Part No.	Länge Length cm	Breite Width cm	Anzahl Löcher Number holes	∅ Loch ∅ Hole cm
1140/020	36	24	21	2
1140/030	36	24	11	3

Drei Füße aus Edelstahl 18/0 zum Hochstellen einer Palette bitte
separat bestellen: / Please order set of three 18/0 stainless steel feet
separately for each palette:

2509/050	5
2509/100	10
2509/150	15

Portionierer

Ice Cream Sundries



Art-Nr. Part No.	Portionsgröße Portion size	∅ außen ∅ Outside mm	Länge Length cm
60/008	1/8 l	70	24
60/010	1/10 l	66	23,5
60/012	1/12 l	63	23,5
60/014	1/14 l	59	23
60/016	1/16 l	56	23
60/020	1/20 l	53	22,5
60/024	1/24 l	50	22
60/030	1/30 l	48	22
60/040	1/40 l	44	21,5
60/050	1/50 l	39	21
60/060	1/60 l	37	21
60/070	1/70 l	35	20,5
60/100	1/100 l	31	20

Wichtiger Pflegehinweis: Federn sind physikalisch bedingt nicht korrosionsbeständig.
Important notice: Springs are not stainless.

Art-Nr. Part No.	Portionsgröße Portion size	∅ dia. mm	Länge Length cm	Farbe Colour
69/008	1/8 l	71	23,5	grau/grey
69/012	1/12 l	64	23,5	grün/green
69/016	1/16 l	57	23,5	blau/blue
69/020	1/20 l	55	23,5	gelb/yellow
69/024	1/24 l	52	23,5	rot/red
69/030	1/30 l	46	23,5	schwarz/black
69/040	1/40 l	40	23,5	violett/purple



Portionierer

aus Edelstahl 18/10, für Eis, Püree, Reis etc., Feder aus Edelstahl 18/0, hochglänzend, hochwertige Qualität

Ice Cream Scoop/Portionier

18/10 stainless steel, mirror polished finish, 18/0 spring, also suitable for rice, mashed potato etc., high quality



Art-Nr. Part No.	Portionsgröße Portion size	Löffelmaß Bowl Size cm	Länge Length cm
68/030	1/30 l	5,5 x 4	23

Wichtiger Pflegehinweis: Federn sind physikalisch bedingt nicht korrosionsbeständig.
Important notice: Springs are not stainless.



Portionierer

aus Edelstahl 18/10, mit farbigem Griff aus Polyamid, temperaturresistent +85°C, spülmaschinengeeignet, mit integriertem Federmechanismus, Größen farbcodiert

Ice Cream Scoop/Portionier

18/10 stainless steel, with coloured polyamide handle, suitable for up to +85°C, dishwasher proof, integral spring, colour coded by size



Art-Nr. Part No.	Portionsgröße Portion size	Löffelmaß Bowl Size cm	Länge Length cm
161/012	1/12 l	6 x 5	17,5
161/016	1/16 l	6 x 4,5	17,5
161/020	1/20 l	5 x 4	17,5
161/024	1/24 l	5 x 3,5	17,5



Portionierer, oval

aus Edelstahl 18/10, Feder aus Edelstahl 18/0, hochglänzend poliert

Oval Ice Cream Scoop

18/10 stainless steel, 18/0 spring, mirror polished finish



Art-Nr. Part No.	Löffelmaß Bowl Size cm	Länge gesamt Total Length cm
946/215	6 x 4	21,5



Eisdipper

aus Aluminium, PTFE-beschichtet, mit wärmeleitender Flüssigkeit im Griff

Ice Cream Dipper

aluminium, PTFE-coated, handle filled with heat-conductive fluid



Art-Nr. Part No.	Fläche Size cm	Länge gesamt Total Length cm
247/230	9 x 7,5	23



Eisdipper

Serie POLARIS, mit seidenmatt poliertem Griff aus Edelstahl 18/10, Arbeitsteil aus hochglänzendem Edelstahl 18/0

Ice Cream Scoop

with hanging loop, handle 18/10 stainless steel, bowl 18/0 stainless steel, suitable for soft scoop ice cream only



Eisspatel

aus Edelstahl, mit schwarzem Kunststoffgriff, hochglänzend, extra schwere Qualität

Ice Cream Spade

stainless steel, with black plastic handle, mirror polished finish, heavy gauge



Speiseeis-Behälter

für Eisvitrinen, aus Edelstahl 18/10, seidenmatt poliert, schwere Qualität

Ice Cream / Napoli Pan

18/10 stainless steel, satin polished finish, heavy gauge, suitable for ice cream cabinets

18/10
EDELSTAHL
STAINLESS STEEL



Art-Nr. Part No.	Länge Length cm	Breite Width cm	Höhe Height cm	
---------------------	-----------------------	-----------------------	----------------------	--

7130/170 26,5 16 18 4,7 l

Flacher Deckel aus Polycarbonat hierzu:

Matching flat polycarbonate lid:

7022/265 26,5 16 2

7020/080 36 16,5 8 3,5 l

7020/120 36 16,5 12 5 l

7020/150 36 16,5 15 6,5 l

7020/170 36 16,5 18 7,7 l

Flacher Deckel aus Polycarbonat hierzu:

Matching flat polycarbonate lid:

7022/360 36 16,5 2

7025/080 36 25 8 5 l

7025/120 36 25 12 8 l

7025/150 36 25 15 10,5 l

7025/180 36 25 17 12,5 l

Kuppelförmiger Deckel aus Polycarbonat hierzu:

Matching domed polycarbonate lid:

7025/360 36 25 8,5

Speiseeis-Behälter, rund

aus Edelstahl 18/10, einwandig

Ice Cream Well

18/10 stainless steel, single walled

18/10
EDELSTAHL
STAINLESS STEEL



Art-Nr. Part No.	∅ dia. cm	Höhe Height cm	
---------------------	-----------------	----------------------	--

7132/070 20 24 7,3 l

Passender Deckel aus Polycarbonat: / Matching polycarbonate lid:

7132/907 20

Ziegeleisform

aus Edelstahl 18/10, seidenmatt gebürstet, mit sauber verschweißten Nähten, Deckel und Boden abnehmbar, schwere Qualität

Ice Cream Brick Mould

18/10 stainless steel, satin brushed finish, with welded edges, removable lid and base, heavy gauge

18/10
EDELSTAHL
STAINLESS STEEL



Art-Nr. Part No.	Länge Length cm	Breite Width cm	Höhe Height cm	
---------------------	-----------------------	-----------------------	----------------------	--

874/100 28,5 9,5 4,5 1 l

874/150 33,5 11,5 4,5 1,5 l

874/200 34 14 4,5 2 l

Eisbombenform

aus Edelstahl 18/10, hochglänzend poliert, mit Deckel

Ice Cream Bomb Mould

18/10 stainless steel, mirror polished, with lid

18/10
EDELSTAHL
STAINLESS STEEL



Art-Nr. Part No.	Portionsgröße Portion size	∅ dia. cm	Höhe Height cm
---------------------	-------------------------------	-----------------	----------------------

876/080 0,125 l 8 4,5

876/100 0,25 l 10 7

876/120 0,5 l 12 8

876/140 0,75 l 14 9

876/160 1 l 16 9,5

876/180 1,5 l 18 11

876/200 2 l 20 12

Höhenangabe mit Fuß und Deckel

Height includes foot and lid.

Cassata-Eisform

mit Deckel, aus Edelstahl 18/10, hochglänzend, schwere Qualität

Cassata Mould

with lid, 18/10 stainless steel, mirror polished, heavy gauge

18/10
EDELSTAHL
STAINLESS STEEL



Art-Nr. Part No.	Portionsgröße Portion size	∅ max. cm	Höhe Height cm
---------------------	-------------------------------	--------------	----------------------

873/050 0,5 l 9,5 8,5

873/100 1 l 12,5 10



Buffet & Events

Mit dem Buffet-Sortiment von contacto stemmen Sie jedes Event und Bankett mit Bravour. Neben Ihrer Planung und Kochkunst ist auch die richtige Speisenpräsentation ein wichtiger Faktor für den Erfolg. Mit der passenden Grundausstattung setzen Sie Ihre Speisen und Getränke ins richtige Licht.

Buffet & Events

*With our range you can handle every buffet and banquet with flying colours.
In addition to your planning and cooking, the right presentation of food is vital for success.
Here you will find the right equipment to impress and deliver.*

Seite Page
288

Chafing Dish
Chafing Dishes



Seite Page
293

Buffet Noir
Buffet Noir



Seite Page
296

Buffet One
Buffet One



Seite Page
300

Ergonom
Ergonom



Seite Page
304

Getränkbuffet & Kühlung
Cold Buffet



Seite Page
308

Buffetständer & Bretter
Buffet Presentation



Seite Page
314

Buffet- & Bankettplatten
Buffet & Banqueting Trays





Chafing Dish

Der Chafing Dish ist der Mittelpunkt jedes Buffet und Catering-Events. Hier finden Sie verschiedene Modelle, Einsätze und Heizelemente.

Chafing Dishes

The Chafing Dish is the focal point of every buffet and catering event. Here you will find different models, inserts and heating elements.

Roll-Top Chafing Dish GN 1/1

aus Edelstahl 18/10, Rahmen aus Edelstahl 18/0, hochglänzend, standardmäßig mit GN 1/1-Einsatz 65 mm und zwei Brennbehältern ausgestattet, Deckel bleibt bei 90° geöffnet, mit handlichen Rohrgriffen, schwere Qualität

Roll Top Chafing Dish

18/10 stainless steel, frame 18/0 stainless steel, mirror polished finish, with a GN 1/1 65 mm pan, lid can rest open at 90°, with tubular handles, heavy gauge



Art-Nr. Part No.	Länge Length cm	Breite Width cm	Höhe Height cm
---------------------	-----------------------	-----------------------	----------------------

Mit zwei Brennbehältern: / With two burner pots:

7093/530	66,5	35	41
----------	------	----	----

Zusätzlich mit regulierbarer elektrischer Heizquelle (Art.7099/002*):
With additional adjustable electric element (7099/002*):

7093/532	66,5	35	41
----------	------	----	----

Zusätzlich mit elektrischer Heizquelle (Art.7099/001*):
With additional electric element (7099/001*):

7093/533	66,5	35	41
----------	------	----	----

*Die Beschreibung der Heizplatten finden Sie auf Seite 292.
*Description of electric elements on page 292.

Chafing Dish GN 1/1

aus Edelstahl 18/10, Rahmen aus Edelstahl 18/0, hochglänzend, standardmäßig mit GN 1/1-Einsatz 65 mm und zwei Brennbehältern ausgestattet, mit handlichen Rohrgriffen, schwere Qualität

Chafing Dish

18/10 stainless steel, frame 18/0 stainless steel, mirror polished finish, with a GN 1/1 65 mm pan, with tubular handles, heavy gauge



Art-Nr. Part No.	Länge Length cm	Breite Width cm	Höhe Height cm
---------------------	-----------------------	-----------------------	----------------------

Mit zwei Brennbehältern: / With two burner pots:

7096/530	66,5	35	35
----------	------	----	----

Zusätzlich mit regulierbarer elektrischer Heizquelle (Art.7099/002*):
With additional adjustable electric element (7099/002*):

7096/532	66,5	35	35
----------	------	----	----

Zusätzlich mit elektrischer Heizquelle (Art.7099/001*):
With additional electric element (7099/001*):

7096/533	66,5	35	35
----------	------	----	----

*Die Beschreibung der Heizplatten finden Sie auf Seite 292.
*Description of electric elements on page 292.

Chafing Dish GN 1/1

Gestell aus Edelstahl 18/0, hochglänzend, mit 65 mm tiefem GN 1/1 Behälter aus Edelstahl und zwei Brennbehältern ausgestattet

Chafing Dish

stainless steel, mirror polished finish, with a GN 1/1 65 mm pan and two burner pots, frame made of 18/0 stainless steel



Art-Nr. Part No.	Länge Length cm	Breite Width cm	Höhe Height cm
---------------------	-----------------------	-----------------------	----------------------

7085/530	56	36	32
----------	----	----	----

Mit Art.7087 und 7089 in eine Suppenstation umrüstbar.
With item 7087 and 7089 this Chafing Dish can be used as a soup station.



Art-Nr. Part No.	Länge außen Outer Length cm	Breite außen Outer Width cm	Höhe gesamt Overall Height cm
---------------------	-----------------------------------	-----------------------------------	-------------------------------------

Mit zwei Brennbehältern: / With two burner pots:			
7076/760	67	49	44 8,5 l

Zusätzlich mit regulierbarer elektrischer Heizquelle (Art.7099/002*): / With additional adjustable electric element (7099/002*):			
7076/762	67	49	44 8,5 l

Zusätzlich mit elektrischer Heizquelle (Art.7099/001*): / With additional electric element (7099/001*):			
7076/763	67	49	44 8,5 l

*Die Beschreibung der Heizplatten finden Sie auf Seite 292.
*Description of electric elements on page 292.



Gold

Roll Top Chafing Dish GN 1/1

aus Edelstahl, hochglänzend, mit vergoldetem Griff, ausgestattet mit einem 65 mm tiefen GN 1/1 Behälter und zwei Brennbehältern, Deckel bleibt in jedem Winkel selbständig geöffnet, schwere Qualität

Roll Top Chafing Dish

stainless steel, mirror polished, with gold plated handle, with a GN 1/1 65 mm pan and two burner pots, lid rest open at any angle, heavy gauge



Art-Nr. Part No.	∅ außen ∅ Outside cm	Höhe gesamt Overall Height cm
---------------------	----------------------------	-------------------------------------

Mit einem Brennbehälter: / With one burner pot:		
7074/740	47	44 6,8 l

Zusätzlich mit regulierbarer elektrischer Heizquelle (Art.7098/002*): / With additional adjustable electric element (7098/002*):		
7074/742	47	44 6,8 l

Zusätzlich mit elektrischer Heizquelle (Art.7098/001*): / With additional electric element (7098/001*):		
7074/743	47	44 6,8 l

*Die Beschreibung der Heizplatten finden Sie auf Seite 292.
*Description of electric elements on page 292.



Gold

Roll Top Chafing Dish

rund, aus Edelstahl, hochglänzend, mit vergoldetem Griff, mit rundem Einsatz (∅ 40 cm) und einem Brennbehälter, Deckel kann bei 90° und 180° Öffnungswinkel arretiert werden, schwere Qualität

Roll Top Chafing Dish, round

stainless steel, mirror polished, with gold plated handle, with ∅ 40 cm insert, lid can rest open at 90° and 180°, heavy gauge



Art-Nr. Part No.	∅ außen ∅ Outside cm	∅ innen ∅ Inside cm	Höhe außen Outer Height cm	
---------------------	----------------------------	---------------------------	----------------------------------	--

Betrieb nur mit Flüssigkeit. Suppenschöpfer aus Edelstahl im Lieferumfang.

Caution: Wet heat only. Shipped with stainless steel ladle.

7055/010	39	28	35	10 l
----------	----	----	----	------



Suppenterrine, elektrisch

Außengehäuse aus schwarzem Polypropylen, herausnehmbarer Einsatztopf und Scharnierdeckel aus Edelstahl, Regelthermostat von +50°C bis +95°C, mit 150 cm Kabel, 220-240V, 400-450 W

Electric Soup Kettle

body made of black polypropylene, stainless steel bain marie pot (removable), with stainless steel hinged lid and soup ladle, adjustable between +50°C and +95°C, 230V AC, 0.45 kW, with 150 cm cable



Art-Nr. Part No.	Höhe Height cm		passend zu Matches
---------------------	----------------------	--	-----------------------

7087/420	17,5	4,2 l	7089/530
----------	------	-------	----------



Bain Marie Topf

Suppenmarmite, aus Edelstahl, hochglänzend, mit Deckel, passend in alle Chafing Dishes GN 1/1

Bain Marie Pot

stainless steel, mirror polished finish, complete with lid, matches all GN 1/1 chafing dishes



Art-Nr. Part No.	GN	∅ Loch ∅ Hole cm
---------------------	----	------------------------

7089/530	1/1	18 cm
----------	-----	-------



Einsatz für zwei Bain Marie Töpfe (7087)

aus Edelstahl, hochglänzend, zur Umrüstung von Chafing Dishes in eine Suppenstation

Lid to take 2 Bain Marie Pots

stainless steel, mirror polished finish, for use in chafing dish as soup station



Sauceneinsatz GN 1/3

aus Edelstahl 18/10, die Einsätze berühren in Saladetten nicht den Kühlboden, die Saucen gefrieren nicht

GN 1/3 Salad Dressing Set

18/10 stainless steel, the inserts do not touch the cold bottom in saladettes, the sauces do not freeze



Art-Nr. Part No.	GN	Höhe Height cm	Ø dia. cm
Einsatzblech GN 1/3 (325 x 176 mm): / Tray GN 1/3 (325 x 176 mm): 7053/013	1/3		

Saucentopf für Chafing Dish (Preis einzeln):

Round container for chafing dishes (priced each):

7053/085 7,5 10 0,65 l

Saucentopf für Saladette (Preis einzeln):

Round container for salad dressing set (priced each):

7053/105 10,5 10 0,8 l

Einsatz für Eier

aus Edelstahl 18/10, hochglänzend, für alle Chafing Dish GN 1/1, Lochdurchmesser 35 mm, hält 38 gekochte Eier über längere Zeit warm

Boiled Egg Frame

18/10 stainless steel, mirror polished, suits all GN 1/1 Chafing Dishes, 35 mm holes, keeps 38 eggs warm



Art-Nr. Part No.	Länge Length cm	Breite Width cm	Höhe Height cm
7047/038	47	28,5	3

passend in alle Edelstahl-Behälter GN 1/1 (ab 40 mm Tiefe)
suitable for all GN 1/1 containers (40 mm and deeper)

Wärmesand

für Chafing Dishes, deutscher Granitsplitt mit feiner Körnung, hohe Wärmekapazität, kein Ankleben wie bei Thermo-salz, ideal zum Warmhalten von Eiern

Granite Chips

for chafing dishes, fine German granite chippings with fine grain size, high heat capacity, no adhesion of thermo-salt, ideal for keeping eggs warm



Art-Nr. Part No.	Gewicht Weight		Farbe Colour
2799/071	7 kg	4,5 l	hellgrau/light grey
2799/072	7 kg	4,5 l	rot/red
2799/073	7 kg	4,5 l	gelb/yellow

Eine Packung reicht zum Befüllen eines GN 1/1 65 mm Einsatzes zu zwei Dritteln.

One 7 kg box fills two thirds of a GN 1/1 65 mm pan.

Löffelablage

aus Edelstahl, hochglänzend poliert, zur Ablage von bis zu zwei Löffeln

Spoon Rest

stainless steel, mirror polished finish, for up to two spoons



Art-Nr. Part No.	Länge Length cm	Breite Width cm

PRODUKTION
EINGESTELLT
PRODUCTION
DISCONTINUED

Deckelablage für Chafing Dish

aus verchromtem Stahldraht, geeignet für Chafing Dish 7085, 7096 und andere handelsübliche, zum Einhängen in den Chafing Dish-Rahmen

Lid holder for Chafing Dish

chrome plated wire, suitable for e.g. 7085, 7096



Art-Nr. Part No.	Breite Width
7081/001	16 cm



Art-Nr. Part No.	∅ dia.	Höhe Height cm
7073/001	9,3	6,5



Brennbehälter

aus Edelstahl, Ersatzbehälter passend zu allen mit Brennpaste beheizbaren Chafing Dish von Contacto

Burner Pot

stainless steel, spare pot matches all Contacto chafing dishes with fuel burner



Art-Nr. Part No.	Gewicht Weight
7049/001*	0,2 kg

*Preis je Stück. Lieferbar im Karton à 72 Stück oder einzeln
*Priced each. Only available in boxes of 72 cans.

Nachfüllpaste: / Refill:

7049/040**	4 kg
------------	------

**Lieferbar im Karton à 4 Stück oder einzeln.

**Priced each. Only available in boxes of 4 cans.

Angaben gemäß Chemikaliengesetz: Der Inhaltsstoff ist dem Einsatzzweck dienend leichtentzündlich. Gesundheitsschädlich (Xn) nur beim Einatmen, Verschlucken und Hautkontakt.

Intentionally highly flammable. Harmful.



Brennpaste

Brennstoffbasis: Ethanol, passend zu allen lieferbaren Brennbehältern, Brenndauer ca. 3 Std. pro 0,2 kg

Chafing Dish Fuel

main chemical base: ethanol, small cans match all our burner pots and lasts about 3 hrs, not available for the UK & Ireland

Art-Nr. Part No.	Länge Length cm	Breite Width cm
7649/060	6,5	3

Auf diesen Artikel können sehr gut Werbetexte aufgebracht werden, wie beispielhaft in der Abbildung gezeigt.

Advertising texts can be applied very well to this item, as shown in the illustration.



Brennpastenschlüssel

aus Edelstahl 18/0, zum leichten Öffnen von Brennpastendosen, kann am Schlüsselbund befestigt werden

Can Opener

18/0 stainless steel, for opening chafing dish fuel cans, can be added to a key-ring



Art-Nr. Part No.	∅ dia. cm	Höhe Height cm
7539/090	10,5	8

Der Brenner kann mit handelsüblichen LPG Gas betrieben werden.
The burner can be operated with ordinary LPG gas.



Chafing Dish Gasheizung

sparsame Alternative zu Brennpasten, gut kontrollierbar, kann im Betrieb angefasst werden, nachfüllbar, Brenndauer bei maximaler Auslastung bis zu 5 Stunden, sicher, da selbstverschließend bei Sturz, sauber durch ruß-, geruchs- und rückstandsfreien Betrieb

Gas Heater for Chafing Dish

economical alternative to traditional gels, easy to control, can be touched during operation, refillable, burning time at maximum capacity up to 5 hours, auto cut and if tipped soot, odour and residue-free operation, not available for the UK + Ireland



Heizplatte, achteckig

aus Aluminium, für runde und ovale Chafing Dish, elektrisch, 230 V, 500W, Heizfläche 20 x 20 cm, mit 2,5 m Anschlusskabel, zusammen mit speziellen Wasserbadwannen zur Umrüstung der Chafing Dish auf elektrische Betriebsweise

Electric Element

aluminium, octagonal, for round/oval chafing dishes, 230 V AC, 500W, plate measures 20 x 20 cm, with 2.5 m cable, for conversion of chafing dishes to electrical use with special water wells



ALU
ALUMINIUM

Art-Nr. Part No.	Länge Length cm	Breite Width cm	Höhe Height cm
---------------------	-----------------------	-----------------------	----------------------

Selbstregulierend / Non adjustable

7098/001	25	20	2
----------	----	----	---

Regulierbar / Adjustable

7098/002	25	20	2
----------	----	----	---

Wichtiger Hinweis: Heizplatte darf nicht im Wasserbad benutzt werden. Wir rüsten Ihre bestehende Wasserbadpfanne auf Wunsch für den elektrischen Betrieb um.

Important notice: Not for use in water. The water basin has to be prepared for installation.

Heizplatte

aus Aluminium, für rechteckige Chafing Dish, elektrisch, 230 V AC, Heizfläche 25 x 20 cm, mit 2,5 m Anschlusskabel, zusammen mit speziellen Wasserbadwannen zur Umrüstung der Chafing Dish auf elektrische Betriebsweise

Electric Element

aluminium, for rectangular chafing dishes, 230 V AC, measures 25 x 20 cm, with 2.5 m cable, for conversion of chafing dishes to electrical use along with special water wells



ALU
ALUMINIUM

Art-Nr. Part No.	Länge Length cm	Breite Width cm	Höhe Height cm
---------------------	-----------------------	-----------------------	----------------------

Selbstregulierend bei 500 W / Non adjustable 500 W

7099/001	30	20	2
----------	----	----	---

Regulierbar bis 700 W / Adjustable 700 W

7099/002	30	20	2
----------	----	----	---

Wichtiger Hinweis: Heizplatte darf nicht im Wasserbad benutzt werden. Wir rüsten Ihre bestehende Wasserbadpfanne auf Wunsch für den elektrischen Betrieb um.

Important notice: Not for use in water. The water basin has to be prepared for installation.

Elektrische Badheizung für GN 1/1

für Chafing Dishes, aus 8,5 mm starkem Chrom-Nickel-Molybdän-Stahl, 230 V, Nennleistung 1000 W, mit 3 m Netzkabel

Electric Element GN 1/1

for chafing dishes, 8.5 mm thick chrome nickel molybdenum steel wire, 230 Volt AC, 1 kW, 3 m cable, fit over edge of water wells



INOX
EDELSTAHL
STAINLESS STEEL

Art-Nr. Part No.	GN
---------------------	----

6611/001	1/1
----------	-----

Wichtiger Hinweis: Heizung nur im Wasserbad benutzen, sonst besteht Überhitzungsgefahr.

Important notice: Only for use in water, otherwise potential danger of overheating.

Warmhalteplatte

Rahmen aus hochglänzendem Edelstahl 18/10, Warmhalteplatte aus Aluminium

Food Warmer

18/10 stainless steel frame, mirror polished finish, aluminium plate



18/10
EDELSTAHL
STAINLESS STEEL

ALU
ALUMINIUM

Art-Nr. Part No.	Länge Length cm	Breite Width cm	Höhe Height cm
---------------------	-----------------------	-----------------------	----------------------

Mit zwei Teelichtern: / With two nightlight candles:

191/330	33	18	6,5
---------	----	----	-----

Mit drei Teelichtern: / With three nightlight candles:

191/450	45	18	6,5
---------	----	----	-----

Ersatz-Teelichtbehälter: / Spare nightlight candle holder:

191/901



Buffet NOIR

Schwarze Magie. Buffet NOIR hält der Hitze am Buffet stand.
Ein Klassiker mit dem gewissen Extra: den hitzeresistenten Griffen.

Buffet NOIR

*Black magic. Buffet Noir stands out.
A classic with a certain extra: the heat-resistant handles.*



- aus Edelstahl
- hochglanzpoliert
- einsetzbar unter Wärmebrücken
- Polyamid-Griffe
- mit Einhängenhaken
- bruchsicher
- *stainless steel*
- *mirror polished finish*
- *polyamide handles*
- *with hooks*
- *virtually unbreakable*

Eine hochwertige Serie schwerer Qualität für den Buffet-Service. Ideal für die Selbstbedienung am Chafing-Dish. Die Griffe aus Polyamid sind temperaturresistent bis +120°C und können daher unter Wärmebrücken eingesetzt werden.

A quality range of buffet utensils suitable for use with chafing dishes. The nearly unique moulded black polyamide handles are heat resistant up to 120°C.

Art-Nr. Part No.	Löffelmaß Bowl Size cm	Länge gesamt Total Length cm
8943/310	7 x 11	31
8943/350	7 x 11	35



Chafing Dish Löffel
Serving Spoon

Art-Nr. Part No.	Löffelmaß Bowl Size cm	Länge gesamt Total Length cm
8944/310	6 x 10	31
8944/350	7 x 10,5	35



Chafing Dish Löffel, perforiert
Perforated Spoon

Art-Nr. Part No.	Löffelmaß Bowl Size cm	Länge gesamt Total Length cm	
8941/340	9 x 8,5	34	0,1 l



Suppenschöpfer
Soup Ladle

Suppenschöpfer, rund
Soup Ladle



Art-Nr. Part No.	Löffelmaß Bowl Size cm	Länge gesamt Total Length cm	
8954/340	9 x 10,5	34	0,2 l

Saucenkelle
Sauce Ladle



Art-Nr. Part No.	Löffelmaß Bowl Size cm	Länge gesamt Total Length cm	
8942/280	7 x 5,5	28	0,03 l

Salatlöffel
Salad Spoon



Art-Nr. Part No.	Löffelmaß Size cm	Länge gesamt Total Length cm
8946/300	5 x 7	30

Salatgabel
Salad Fork



Art-Nr. Part No.	Löffelmaß Bowl Size cm	Länge gesamt Total Length cm
8947/300	5 x 7	30

Spaghettiheber
Spaghetti Lifter



Art-Nr. Part No.	Löffelmaß Bowl Size cm	Länge gesamt Total Length cm
8951/320	10 x 7	32



Art-Nr. Part No.	Länge Length cm
8952/240	24



Servierzange
Serving Tongs

Art-Nr. Part No.	Spatelmaß Blade cm	Länge gesamt Total Length cm
8945/350	7,5 x 9,5	35



Pfannenwender
Slice

Art-Nr. Part No.	Schaufelmaß Scoop dimension cm	Länge gesamt Total Length cm
8948/280	9 x 10,5	28



Pommes frites-Schaufel
Chip Scoop

Art-Nr. Part No.	Zinkenlänge Prongs Length cm	Länge gesamt Total Length cm
8949/360	6,5	36



Bratengabel
Meat Fork

Art-Nr. Part No.	Spatelmaß Blade cm	Länge gesamt Total Length cm
8953/320	7 x 12	33



Tortenheber
Cake Lifter

Buffet One

First Class am Buffet. Edelstahl bis ins Detail in vollendete Form gebracht. Der Anspruch an Ihre Speisen sollte sich im Besteck widerspiegeln.

Buffet One

First class buffet. Stylish stainless steel down to the last detail. The demands on your food should be reflected in delivery, as it is here.

Eine klassische Buffetserie in bester Verarbeitung. Ideal für die Selbstbedienung am Buffet. Gefertigt aus Edelstahl 18/10 mit seidenmatt polierten Griffen und hochglänzenden Arbeitsteilen. Die hohe Materialstärke und edle Polierung verleiht dem Produkt seine Wertigkeit. Das Ende des Griffes ist abgewinkelt und erleichtert das Greifen.

This classic range of buffet utensils comes mirror polished with satin finished handles. The products are made of 18/10 stainless steel in a heavy gauge. The well designed end of the handles makes their use easier. Ideal for self-service areas.



- schwere Qualität
- fugenlos
- hochwertig verarbeitet
- seidenglänzender Griff
- Abstellwinkel am Griff
- klassische Buffetserie
- *heavy gauge*
- *one piece*
- *excellent finish*
- *satin polished handle*
- *well designed handles*
- *classic buffet range*

Chafing Dish-Löffel

Serving Spoon



Art-Nr. Part No.	Löffelmaß Bowl Size cm	Länge gesamt Total Length cm
3352/310	10 x 7	31
3352/370*	10 x 7	37

*Löffel mit 37 cm Länge können am Rand des Chafing-Dishes abgelegt werden ohne in diesen hinein zu rutschen.

*37 cm spoons can rest on the rim of a Chafing Dish without slipping into it.

Chafing Dish-Löffel, längs perforiert

Slotted Serving Spoon



Art-Nr. Part No.	Löffelmaß Bowl Size cm	Länge gesamt Total Length cm
3353/310	10 x 7	31
3353/370*	10 x 7	37

*Löffel mit 37 cm Länge können am Rand des Chafing-Dishes abgelegt werden ohne in diesen hinein zu rutschen.

*37 cm spoons can rest on the rim of a Chafing Dish without slipping into it.

Servierlöffel

Serving Spoon



Art-Nr. Part No.	Löffelmaß Bowl Size cm	Länge gesamt Total Length cm
1846/240	8 x 5	24



Art-Nr. Part No.	Löffelmaß Bowl Size cm	Länge gesamt Total Length cm
1847/245	8 x 5	24



Servierlöffel, perforiert
Slotted Spoon

Art-Nr. Part No.	Ø dia. cm	Stiellänge Handle Length cm	
3350/300	8	24	0,1 l



Suppenschöpfer
Soup Ladle

Art-Nr. Part No.	Ø cm dia. cm	Stiellänge Handle Length cm	
3351/255	6,5	20	0,05 l



Portionsvorleger
Serving Ladle

Art-Nr. Part No.	Länge Length cm	Ø dia. cm	
3357/210	20,5	6	0,025 l



Saucenkelle
beidseitige Ausgussschnaupe
Sauce Ladle
with two pouring lips

Art-Nr. Part No.	Ø dia. cm	Stiellänge Handle Length cm	
3354/335	4,5	30	0,03 l



Dressinglöffel
Dressing Ladle

Salatlöffel
Salad Spoon



Art-Nr. Part No.	Löffelmaß Bowl Size cm	Länge gesamt Total Length cm
3356/305	8,5 x 6	30,5

Salatgabel
Salad Fork



Art-Nr. Part No.	Löffelmaß Bowl Size cm	Länge gesamt Total Length cm
3355/305	8,5 x 6	30,5

Salatlöffel, klein
Small Salad Spoon



Art-Nr. Part No.	Löffelmaß Bowl Size cm	Länge gesamt Total Length cm
3363/235	5,5 x 4,5	23,5

Salatgabel, klein
Small Salad Fork



Art-Nr. Part No.	Löffelmaß Size cm	Länge gesamt Total Length cm
3364/235	5,5 x 4,5	23,5

Spaghettiheber
Spaghetti Server



Art-Nr. Part No.	Löffelmaß Bowl Size cm	Länge gesamt Total Length cm
3359/315	10 x 6,5	31,5

Servierzange
Serving Tongs



Art-Nr. Part No.	Länge außen Outer Length cm
3369/195	19,5



Art-Nr. Part No.	Länge Length cm
3362/300	30



Servierzange
Serving Tongs

Art-Nr. Part No.	Spatelmaß Blade cm	Länge gesamt Total Length cm
3361/320	10,5 x 7,5	31,5
3361/380	10,5 x 7,5	38



Pfannenwender
Slotted Slice

Art-Nr. Part No.	Zinkenlänge Prongs Length cm	Länge gesamt Total Length cm
3367/290	13	28,5



Tranchiergabel
Carving Fork

Art-Nr. Part No.	Zinkenlänge Prongs Length cm	Länge gesamt Total Length cm
3360/340	9,5	34



Bratengabel
Meat Fork

Art-Nr. Part No.	Zinkenlänge Prongs Length cm	Länge gesamt Total Length cm
3365/195	4	19,5



Aufschnittgabel
Serving Fork

Art-Nr. Part No.	Spatelmaß Blade cm	Länge gesamt Total Length cm
3366/230	11,5 x 6	23,5

3366/290 17 x 6,5 29
speziell für 40 cm Landkuchen (bis 16 Stücke)
especially for large cakes of 40 cm cut into 16 pieces



Tortenheber
Griff bleibt aufrecht stehen
Pastry Server
Handle remains upright



Ergonom

Greifbare Eleganz. Die zeitlosen Buffetbestecke der Ergonom-Serie von **contacto** empfehlen sich für den Einsatz am klassischen als auch am jungen, trendigen Buffet.

Ergonom

*Tangible elegance. Timeless buffet utensils from **contacto**'s Ergonom range is recommended for both classic and modern buffets.*

Die Ergonom-Serie von **contacto** eignet sich aufgrund seiner hochglänzenden edlen Optik für Buffet und Tafel.

Alle Teile sind fugenlos mit polierten, ergonomischen Griffen die aus rostfreien Edelstahl 18/10 bestehen mit den Arbeitsteilen die aus hochwertigem Edelstahl 18/0 gefertigt sind verbunden.

The Ergonom series from **contacto** is suitable for buffets and dinner tables due to its mirror polished, elegant appearance.

All parts are seamless with polished, ergonomic handles made of 18/10 stainless steel and the rest are made of high quality 18/0 stainless steel.



- ergonomisch profilierter Griff aus Edelstahl 18/10
- hochglänzend
- fugenlos
- ideale Tafelserie

- *ergonomically designed handles made of 18/10 stainless steel*
- *mirror polished finish*
- *seamless*
- *ideal tableware range*

Servierlöffel

Serving Spoon



Art-Nr. Part No.	Löffelmaß Bowl Size cm	Länge gesamt Total Length cm
7780/320	9 x 6,5	32

Servierlöffel, perforiert

Lochung Ø 4 mm

Perforated Spoon

4 mm perforations



Art-Nr. Part No.	Löffelmaß Bowl Size cm	Länge gesamt Total Length cm
7788/320	9 x 6,5	32

Pfannenschaufel

Slotted Slice



Art-Nr. Part No.	Spatelmaß Blade cm	Länge gesamt Total Length cm
7795/360	10,5 x 8	36

Art-Nr. Part No.	Löffelmaß Bowl Size cm	Länge gesamt Total Length cm
7787/300	8 x 6,5	30



Salatlöffel
Salad Spoon

Art-Nr. Part No.	Löffelmaß Bowl Size cm	Länge gesamt Total Length cm
7786/300	8 x 6,5	30



Salatgabel
Salad Fork

Art-Nr. Part No.	Ø dia. cm	Stiellänge Handle Length cm
7785/070	0,06 l	7
7785/090	0,1 l	9



Schöpfkelle
Soup Ladle

Art-Nr. Part No.	Löffelmaß Bowl Size cm	Stiellänge Handle Length cm	
7790/290	7 x 5,5	22	0,02 l



Saucengießlöffel
mit einseitiger Ausgusschnaupe
Sauce/Gravy Ladle
with one pouring lip

Art-Nr. Part No.	Löffelmaß Bowl Size cm	Länge gesamt Total Length cm
7791/310	8 x 6,5	31



Spaghettiheber
Spaghetti Server

Tranchiergabel

Fork



Art-Nr. Part No.	Zinkenlänge Prongs Length	Länge gesamt Total Length
7781/320	8 cm	32 cm

Tranchiermesser

mit Wellenschliff

Carving Knife

with serrated edge



Art-Nr. Part No.	Klingenlänge Blade cm	Klingenlänge Blade Zoll	Länge gesamt Total Length cm
7782/310	20	8"	31

Steak-/ Tomatenmesser

mit gezahnter Klinge

Steak / Tomato Knife

with serrated edge



Art-Nr. Part No.	Klingenlänge Blade cm	Klingenlänge Blade Zoll	Länge gesamt Total Length cm
7784/245	12	5"	24,5

Kuchenmesser

mit Wellenschliff, durch extrabreite Klinge auch als Kuchenheber zu verwenden

Cake Knife

with wavy edge



Art-Nr. Part No.	Klingenlänge Blade cm	Klingenlänge Blade Zoll	Länge gesamt Total Length cm
7783/300	18	7"	30

Tortenmesser

eine Kante gezahnt, durch extrabreite Klinge auch als Kuchenheber zu verwenden

Cake Slice

one edge serrated



Art-Nr. Part No.	Klingenlänge Blade cm	Klingenlänge Blade Zoll	Länge gesamt Total Length cm
7792/280	15,5	6"	28

Tortenheber mit Messer

Materialstärke 1,6 mm, extra schwere Qualität

Cake/Pie Lifter

material thickness 1.6 mm, heavy gauge



Art-Nr. Part No.	Spatelmaß Blade cm	Länge gesamt Total Length cm
7793/280	14 x 5,5	28



Art-Nr. Part No.	∅ dia. cm	Höhe Height cm
656/350	35	3,5



Holzplatte, drehbar

aus mehrfach verleimten Bambusholz, kugelgelagerter drehbarer Teller, nicht spülmaschinengeeignet

Revolving Cheese Board

multi-layered bamboo, revolving, ball bearing mounted, not dishwasher proof



Art-Nr. Part No.	∅ dia. cm	Höhe Height cm
3689/200	18	13



Käseglocke

aus starkem Polystyrol-Kunststoff, insbesondere passend zu Mönchskopfkäsehobel 3666, Knopf kann abgeschraubt werden, nicht spülmaschinengeeignet

Cheese Cover

strong polystyrene, matches Tête-de-Moine cheese slicer 3666, removable knob, not dishwasher safe



Art-Nr. Part No.	∅ dia. cm	Höhe Height cm
3666/220	22	16

Passende Abdeckhaube aus klarem Polystyrol von Seite 303 (hierfür ohne Griffknopf zu verwenden): / Clear polystyrene cover see page 303 (use without knob herefore):

3689/200	18	13
----------	----	----



Mönchskopfkäsehobel

aus hochdichtem, grob schwarz-weiß marmorierten Polyethylen, hygienisch und geruchsneutral, Hobel ganz aus Edelstahl 18/0, ergonomischer Drehgriff, spülmaschinenfest, zum dekorativen Hobeln von Mönchskopfkäse (Tête-de-Moine) oder Choco Rolles-Schokolade

Tête-de-Moine Cheese Slicer

high density polyethylene, with stainless steel blade, easy to use turning handle, hygienic, dishwasher safe, can also be used for shaving chocolate



Art-Nr. Part No.	∅ außen ∅ Outside cm	∅ innen ∅ Inside cm	Höhe Height cm
674/240	21	20	14



Platte mit Käseglocke

Platte aus Edelstahl 18/10, seidenmatt poliert, Haube aus starkem transparenten Polystyrol

Cheese Tray with Cover

18/10 stainless steel, satin polished finish, with strong transparent polystyrene cover



Art-Nr. Part No.	∅ dia. cm	Höhe Height cm
640/400	40	20



Brett mit Käseglocke

aus hochdichtem schwarz-weiß marmorierten Polyethylen, spülmaschinengeeignet, komplett mit passender Abdeckhaube Art. 646/400 aus klarem Polycarbonat

Cheese Board with Cover

high density polyethylene, dishwasher safe, complete with 646/400 clear polycarbonate rolltop cover



Art-Nr. Part No.	∅ dia. cm	Höhe innen Inner Height cm
679/300	30	7



Käseplatte mit Haube

aus Edelstahl 18/0, mit Haube aus klarem Polystyrol

Cheese Tray with Cover

18/0 stainless steel, with clear polystyrene cover





Getränkebuffet & Kühlung

Vitaminreiche Getränke und kalte Speisen am Frühstücksbuffet und im Konferenzraum.
contacto vereint Hygienerichtlinien mit ansprechender Präsentation.

Cold Buffet

Vitamin-rich drinks and cold dishes in the conference room or at breakfast.

contacto combines good hygiene with appealing presentation. The ultimate in cool!



GN 1/1 Kühlsystem Rolltop

komplettes Set, Außenschale aus schwarzem Kunststoff, mit Tablett GN 1/1 20 mm aus Edelstahl 18/10, vier Kühlakkus, Rolltophaube aus Polycarbonat

GN 1/1 Rolltop Cold Buffet Set

complete set, black plastic, with 18/10 stainless steel GN 1/1 20 mm tray, supplied with four ice packs, polycarbonate roll top cover



Art-Nr. Part No.	Länge Length cm	Breite Width cm	Höhe Height cm
Komplettausstattung mit Haube: / Complete set with cover:			
6201/005	54	34	30

Ersatz Rolltop-Haube: / Spare rolltop lid:			
645/530	54	34	20

(Ersatz)-GN Einsätze: / (Spare) GN Trays:			
7011/020	53	32,5	2

Ersatz-Kühlakku (siehe Seite 305): / Spare Ice Pack (see page 305):			
6207/170	17,5	9,5	

GN 1/1 Kühlsystem

Außenschale aus schwarzem Kunststoff, mit Tablett GN 1/1 20 mm aus Edelstahl 18/10, Lieferung mit vier Kühlakkus

GN 1/1 Cold Buffet Set

black plastic, with 18/10 stainless steel GN 1/1 20 mm tray, supplied with four ice packs



Art-Nr. Part No.	Länge Length cm	Breite Width cm	Höhe Height cm
6201/530	53,5	33,5	10,5

Edelstahlrahmen GN 1/1

aus Edelstahl 18/10, zur Ergänzung des Kühlsystems 6201 oder zum Einstellen von GN 1/1 Behältern bis 65 mm Tiefe

GN 1/1 Frame

18/10 stainless steel, suitable for cold buffet set 6201 or for 1/1 Gastronorm containers up to 65 mm deep



Art-Nr. Part No.	GN	Höhe Height cm
7030/070	1/1	7 cm

6201/005 Kühlsystem* / Cold Buffet Set*
 *Kühlsystem besteht aus Kunststoffschale, vier Kühlakkus, Tablett, Rolltop-Haube
 *Cold Buffet Set consists of black plastic water well, four ice packs, GN 1/1 20 mm tray and a roll top cover



Art-Nr. Part No.	Länge Length cm	Breite Width cm	Höhe Height cm
797/004	33	12,5	10

6207/170 Ersatzkühlakku / Spare ice pack

Die Edelstahl-Oberfläche eignet sich als Werbefläche durch Ätzungen oder zur Anbringung von magnetischen Werbeträgern. Logos can be etched on the surface.



Konferenz-Flaschenkühler

aus schwarzem POM, Abdeckung aus Edelstahl 18/0, zur Kühlung von vier handelsüblichen Flaschen bis 64 mm Durchmesser, mit Kühlakku, Depots für Kapselheber und Kronkorken, Kondenswasser sammelt sich in Bodenwellen

Bottle cooler

for conference room, black POM, 18/0 stainless steel cover, cools four bottles up to 64 mm diameter, includes ice pack, slots for opener and caps, condensed water drains into the bottoms waves



Art-Nr. Part No.	Länge Length cm	Breite Width cm	Tiefe Depth cm	Gewicht Weight kg
6207/170	17,5	9,5	3,5	0,35



Kühlakku

zur Kühlung von Speisen und Getränken, lange Kühdauer durch Spezialgel

Ice Pack

blue plastic shell, keep cold for a long time due to a special gel



Art-Nr. Part No.	Höhe Height cm	Ø dia. cm	VPE carton qty
2710/100	29	11	1 l



Glaskaraffe

aus leichtem Kristallglas, mit nach dem Kippen selbstschließendem Verschlussdeckel, breite Ausgusschnaupe mit innen liegendem Filter aus Silikon, hält z.B. Kräuterblätter und Fruchtstücke beim Ausgießen zurück, spülmaschinengeeignet

Glass Carafe

light crystal glass, self closing lid, wide silicone pouring lip with inside filter, dishwasher safe



Art-Nr. Part No.	Ø oben Ø Top cm	Höhe Height cm	VPE carton qty
2708/025	6	14	0,25 l 6
2708/050	6	18,5	0,5 l 6
2708/100	6	25	1 l 6

Preise je Verpackungseinheit. Ersatzdeckel auf Anfrage.
Priced per carton quantity. Spare lids on request.



Weck® Saftflaschen

mit Glasdeckel, gut geeignet für Buffets, 6 Stück im Karton (VE)

Weck® Glass Carafes

with glass lid



Art-Nr. Part No.	Höhe Height cm
5350/090	0,9 17,5
5350/160	1,6 20,5



Getränkekanne

aus transparentem Polycarbonat, spülmaschinengeeignet, einsetzbar von -30°C bis +120°C, unzerbrechlich

Water Jug

transparent polycarbonate, suitable for use between -30°C and +120°C, dishwasher proof, virtually unbreakable



Müslispender

Rahmen und Abstellplatte aus hochglänzendem Edelstahl, Behälter aus Polycarbonat, Dosiermechanismus auch für feinkörnige Zerealien

Cereal Dispenser

stainless steel frame and drip tray, mirror polished, polycarbonate container, dispensing mechanism enables individual portion control, usable for fine grained cereals



Art-Nr. Part No.	Höhe Height cm	Tiefe Depth cm	
3093/007	64	33	7 l

Buffet-Pyramide

drei Seiten mit jeweils 21 Aussparungen für Partylöffel und 15 Löchern (3 mm Ø) für Spieße, aus Edelstahl, matt poliert

Buffet Pyramid

3 sided with 21 slots for canapé spoons and 15 holes (Ø 3 mm) for cocktail sticks each side, stainless steel, satin polished



Art-Nr. Part No.	Breite max. Max. Width cm	Breite min. Min. Width cm	Höhe Height cm

PRODUKTION
EINGESTELLT
PRODUCTION
DISCONTINUED

Saftdispenser

Fassungsvermögen zweimal 8 Liter, Rahmen, Abtropfschale und Lochblech aus Edelstahl, Behälter mit Eiströhre und Hahn 3/8" aus Kunststoff

Juice Dispensers

stainless steel frame and drip tray, pair of plastic containers, with ice tube, each contains 8 litres, with 3/8" taps



Art-Nr. Part No.	Länge Length cm	Tiefe Depth cm	Höhe gesamt Overall Height cm	
3092/002	54	36	56	8 l

Saftdispenser

Fassungsvermögen 8 Liter, Rahmen, Abtropfschale und Lochblech aus Edelstahl, Behälter mit Eiströhre und Hahn 3/8" aus Kunststoff

Juice Dispenser

stainless steel frame and drip tray, 8 litres plastic containers, with ice tube, with 3/8" taps



Art-Nr. Part No.	Länge Length cm	Tiefe Depth cm	Höhe gesamt Overall Height cm	
3096/001	36	26	56	8 l



Art-Nr.	Höhe
Part No.	Height
1088/500	48 cm



Orangensaftpresse

verchromter Zinkguss, Pressschale, Kegel und Drücker aus Edelstahl 18/10, schwere Qualität

Citrus Press

chrome plated zinc alloy, 18/10 stainless steel cup, press and lever, heavy gauge



Art-Nr.	Höhe
Part No.	Height
1099/520	60 cm



Orangensaftpresse

aus verchromtem Zinkguss, hochglänzend, mit herausnehmbarem Einsatz aus Edelstahl 18/10, mit rückfederndem Hebel

Citrus Press

chrome plated zinc, mirror polished finish, 18/10 stainless steel strainer



Art-Nr.	Länge	Breite	Höhe
Part No.	Length	Width	Height
	cm	cm	cm
1011/360	18	13	36,5



Zitruspresse

leichte Ausführung, verchromter Stahl, Pressschale aus Edelstahl, mit Auffangbecher

Citrus Press

chrome plated, stainless steel pressure cup



Buffetständer & Bretter

Retro. Rund. Rustikal. Präsentieren Sie im Glas in platzsparenden Gestellen. Steigen Sie mit Etageren in die Höhe. Und mit Holzbrettern zur Bretteljause.

Buffet Presentation

Afternoon tea, breakfast, lunch, whenever it'll be, Weck® glass jars, wooden boards and three tier stands, it's ABC!

Serviergestell mit Tulpengläser von Weck®

aus verchromtem Stahldraht, mit 4 bzw. 8 bauchigen Weckgläsern 220 ml in Tulpenform, auch für zylindrische Sturzgläser von Weck® geeignet

Weck® Glass Jars Stand

chrome plated wire, with four or eight 220 ml Tulip Weck® glass jars, can also be used with traditional German conical Weck® glass preserving jars, too



Art-Nr. Part No.	Länge Length cm	Breite Width cm	Höhe Height cm	Anzahl Fächer Slots
---------------------	-----------------------	-----------------------	----------------------	------------------------

Lieferung komplett mit Tulpengläsern 2706/220 mit Deckeln: /
Supplied complete with 2706/220 glass jars and lids:

3295/004	21	22	21,5	4
3295/008	38	22	21,5	8

Nur Gestell ohne Gläser und Deckel: / Stand only without glass jars and lids:

3295/840	21	22	21,5	4
3295/880	38	22	21,5	8

Passende Gläser hierzu: / Matching glass jars and lids:

2706/220		6	8	VPE 12
2707/050		6	3,5	VPE 12
2707/080		6	5,5	VPE 12
2707/140		6	7,5	VPE 12
2707/160		6	8,5	VPE 12

Weck® Tulpenglas

mit Glasdeckel, ideal für Buffets

Tulip Weck® Glass Jar

traditional German 'Weck®' glass jars, with glass lid, especially suitable for buffets



Art-Nr. Part No.	∅ oben ∅ Top cm	Höhe Height cm	VPE carton qty
2706/220	6	8	220 ml 12
2706/580	10	8,5	580 ml 6

Preise je Verpackungseinheit. Ersatzdeckel auf Anfrage.
Priced per carton quantity. Spare lids on request.

Weck® Sturzglas

mit Glasdeckel, ideal für Buffets

Conical Weck® Glass Jar

traditional German 'Weck®' glass preserving jars, conical shape, with glass lid, especially suitable for buffets



Art-Nr. Part No.	∅ oben ∅ Top cm	Höhe Height cm	VPE carton qty
2707/035	4	3,5	35 ml 24
2707/050	6	3,5	50 ml 24
2707/080	6	5,5	80 ml 24
2707/140	6	7,5	140 ml 12
2707/160	6	8,5	160 ml 12
2707/165	8	4,5	165 ml 12
2707/200	8	5,6	200 ml 12
2707/290	8	8,7	290 ml 6
2707/291	10	5,5	290 ml 6
2707/371	10	6,9	370 ml 6
2707/580	10	10,7	580 ml 6

Preise je Verpackungseinheit. Ersatzdeckel auf Anfrage.
Priced per pack quantity. Spare lids on request.

Glasschalen

Glass Bowls



Art-Nr. Part No.	∅ oben ∅ Top cm	Höhe Height cm	VPE carton qty
2703/110	4	10,5	110 ml 12
2703/200	6	12,5	200 ml 6
2703/370	8	12,5	370 ml 6

Preis je Verpackungseinheit. Ersatzdeckel auf Anfrage.
Priced per carton quantity. Spare lids on request.



Weck® Delikatessenglas

mit Glasdeckel, ideal für Buffets

Deli / Concave Weck® Glass Jar

traditional German 'Weck®' glass, with glass lid, especially suitable for buffets



Art-Nr. Part No.	∅ dia. cm	VPE carton qty
48 Stück Einweckklammern: / 48 pcs. clips:		
2707/048		48

Dichtungsringe: / Gaskets:

2707/940	4	10
2707/960	6	10
2707/961	8	10
2707/962	10	10

Preise je Verpackungseinheit.
Priced per pack quantity.



Weck® Einkochzubehör

Einweckklammern und Dichtungsringe
passend zu allen Weck® Gläsern

Weck® Gaskets and Clips

Gaskets and Clips for all Weck® glasses, 2 clips recommended per jar and lid



Art-Nr. Part No.	∅ dia. cm	Höhe Height cm	VPE carton qty
7036/200	20	18	1,8 l
7036/230	23	25	2,6 l

Zusätzliche Glasschalen: / Additional glass bowls:

2709/200	20	9	1,8 l
2709/230	23	10,5	2,6 l



Buffet-Ständer

aus 8 mm starkem verchromtem Stahl,
mit runder stapelbarer Glasschale,
schwere Qualität, zur Speisenpräsentation

Buffet Wire Stand

8 mm chrome plated steel wire,
with round stackable glass bowl, heavy gauge



Art-Nr. Part No.	Länge Length cm	Breite Width cm	Höhe Height cm
3293/060	23,5	13,5	25

2709/060 Zusätzliche Glasschälchen / Spare glasses



Stapelgestell mit Glasschälchen

aus verchromtem Stahldraht, mit 54 Glasschälchen mit
6 cm Durchmesser, stabile Ausführung, platzsparend,
zur Selbstbedienung am Frühstücksbuffet

Mini Glass Bowl Stand

chrome plated steel wire, with 54 glass bowls of 6 cm
diameter, compact and stable design, for self-service at
breakfast buffets



Art-Nr. Part No.	∅ innen ∅ Inside cm	Höhe Height cm	VPE carton qty
2709/060	0,025 l	5,5	2,5 36
2709/075	0,05 l	7	3,5 36
2709/100	0,21 l	9,5	4,5 36
2709/120	0,33 l	11	5,5 36
2709/140	0,55 l	13	6,5 36
2709/170	1 l	16,5	8 6
2709/200	1,8 l	19	9 6
2709/230	2,6 l	23	10,5 6
2709/260	4,5 l	26	12 6
2709/290	5,6 l	29	13,5 6

Preis je Stück. Bitte beachten Sie die Verpackungseinheiten.
Priced each, packed as shown in table.



Glasschale

aus klarem gehärteten Glas, stapelbar

Glass Bowl

clear tempered glass, stackable



Petits-Fours-Etagere

mit drei Ebenen, aus Edelstahl 18/10, hochglänzend

3 Tier Cake Stand

18/10 stainless steel, mirror polished finish



Art-Nr. Part No.	∅ dia. cm	Höhe Height cm
---------------------	-----------------	----------------------

53/003	20 / 22,5 / 25	39,5
--------	----------------	------

Lieferung mit Montageanleitung.
Supplied flat packed.

Petits-Fours-Ständer

aus Edelstahl 18/10, hochglänzend, schwere Qualität

Petit Four Stand

18/10 stainless steel, mirror polished finish,
heavy gauge



Art-Nr. Part No.	∅ oben ∅ Top cm	∅ unten ∅ Base cm	Höhe gesamt Overall Height cm
---------------------	-----------------------	-------------------------	-------------------------------------

58/145	14,5	6	8
--------	------	---	---

Glas-Etagere

flache gehärtete Glasscheiben, in einem Edelstahlgestell
mit Tragering

2 and 3 Tier Cake Stands

heavy flat tempered glass, with stainless steel stem



Art-Nr. Part No.	∅ dia. cm	Höhe Height cm
---------------------	-----------------	----------------------

Mit zwei Glasscheiben: / 2 tier 3226/002	21 / 25	29
---	---------	----

Mit drei Glasscheiben: / 3 tier 3226/003	21 / 25 / 30	40
---	--------------	----

Einfache Montage.
Supplied flat packed.

Schalen-Etagere

ganz aus Edelstahl, hochglänzend, 2 cm tiefe Schalen

Fruit Stand

stainless steel, mirror polished finish, 2 cm deep bowls



Art-Nr. Part No.	∅ dia. cm	Höhe Height cm
---------------------	-----------------	----------------------

Mit einer Schale / 1 tier 59/001	16	12,5
-------------------------------------	----	------

Mit zwei Schalen / 2 tier 59/002	16 / 27	22
-------------------------------------	---------	----

Mit drei Schalen / 3 tier 59/003	16 / 22 / 27	32
-------------------------------------	--------------	----

Einfache Montage.
Supplied flat packed.

Etageren, dreistufig

aus Edelstahl, hochglänzend

3 Tier Cake Stand

stainless steel, mirror polished finish, with open edges



Art-Nr. Part No.	∅ dia. cm	Höhe Height cm
---------------------	-----------------	----------------------

3232/003	30 / 40 / 50	49
----------	--------------	----

Einfache Montage.
Supplied flat packed.



Art-Nr. Part No.	Höhe Height cm	Breite max. Max. Width cm	∅ Teller ∅ Plate cm
3240/173	31	22,5	17 / 19 / 20
3240/253	39,5	33	25 / 29 / 31
3240/303	51	37,5	32 / 35 / 35,5

Lieferung ohne Teller.
Supplied without plates.



Telleretagere, dreistufig

dreistufig, aus verchromtem 6 bzw. 8 mm starkem Stahldraht, für mindestens 25 cm große Teller, mit Gummifüßen, schwere Qualität

3 Tier Cake Stand

6 and 8 mm chrome plated steel wire, with rubber feet, 25 cm minimum plate diameter, heavy gauge



Art-Nr. Part No.	Höhe Height cm	Breite max. Max. Width cm	∅ Teller ∅ Plate cm
3248/210	47	27,5	18 - 23
3248/255	47	32	23 - 27
3248/300	48	36	27 - 31

Lieferung ohne Teller.
Supplied without plates.



Telleretagere, dreistufig

dreistufig, aus verchromtem 6 und 8 mm starkem Stahldraht, auf Gummifüßen, schwere Ausführung

3 Tier / Cake Stand

3 tier, 6 and 8 mm chrome plated steel wire, with rubber feet, heavy gauge



Art-Nr. Part No.	Höhe Height cm	Breite max. Max. Width cm	∅ Teller ∅ Plate cm
3247/213	47	27,5	17,5 - 23
3247/253	47	32	22,5 - 27
3247/303	48	36	26,5 - 31

Lieferung ohne Teller.
Supplied without plates.



Telleretagere, dreistufig

dreistufig, aus schwarz lackiertem 6 und 8 mm starkem Stahldraht, auf Gummifüßen, schwere Ausführung

Fajita Tower 3 Tier / Cake Stand

3 tier, 6 and 8 mm black painted steel wire, with rubber feet, heavy gauge



Art-Nr. Part No.	Höhe Height cm	∅ Boden ∅ Base cm
3868/035	32	18
3868/050	50	20



Brezelständer

aus lackiertem Buchenholz mit 11,5 cm langen Tragstangen, nicht zerlegbar

Pretzel Stand

lacquered beechwood, with 11.5 cm supports, cannot be taken apart



Holzkasten GN

aus lackiertem Buchenholz, zum Präsentieren auf dem Buffet

GN Wooden Box

lacquered beechwood



Art-Nr. Part No.	GN	Länge Length cm	Breite Width cm	Höhe außen Outer Height cm
3893/011	1/1	53	32,5	10
3893/012	1/2	32,5	26,5	10
3893/013	1/3	32,5	17,6	10

Untergestell, schräg, für Holzkästen: / Riser for Boxes:

3893/910	1/1	53	32,5	9,5
----------	-----	----	------	-----

Holzblock GN 1/2

aus 5 cm starkem Buchen-Stirnholz, besonders robust, lebensmittelecht geölt, auf vier Holzfüßen, nicht spülmaschinene geeignet, extra schwere Qualität, als Buffet- oder Arbeitsplatte einsetzbar

GN 1/2 Wooden Board

5 cm thick beech wood, particularly durable, food friendly oiled, 4 wooden feet, not dishwasher proof, extra heavy gauge, can be used for cutting or at the buffet



Art-Nr. Part No.	Länge Length cm	Breite Width cm	Höhe Height cm
1502/325	32,5	26,5	10

Glasschneidbrett zur hygienischen Speisenpräsentation: / Glass Cutting Board:

1504/300	30	20	
----------	----	----	--

Zwei nebeneinander gestellte Blöcke können durch eine GN 1/1 Abdeckhaube wie 645/530 von Seite 322 geschützt werden.

Two wooden boards placed next to each other would match a GN 1/1 lid such as 645/530 etc. on page 322.

Holzschneidblock GN 1/1

aus 5 cm starkem Buchen-Stirnholz, besonders robust, lebensmittelecht geölt, mit Safrinrinne und Griffmulden, auf vier Gummifüßen, nicht spülmaschinene geeignet, extra schwere Qualität, zum Zerlegen und Tranchieren von Fleisch oder Geflügel oder als Buffet-Platte verwendbar

GN 1/1 Cutting Board

5 cm thick beech wood, particularly durable, food friendly oiled, 4 rubber feet, not dishwasher safe, extra heavy gauge, for cutting and carving meat or poultry or as a buffet plate



Art-Nr. Part No.	Länge Length cm	Breite Width cm	Höhe Height cm
1503/530	53	32,5	6

Passend darauf Rolltop-Haube GN 1/1 für Buffet: / Matches a GN 1/1 lid:

645/530	54	33,5	19
---------	----	------	----

Ersatzfüßchen erhältlich.

Spare feet available.

Holzschneidblock

verleimte Stirnholzplatte aus Buchenholz, lebensmittelecht geölt, nicht spülmaschinene geeignet, zum Auslegen von Speisen

Beech End Grain Cutting Board

beech wood, food friendly oiled, not dishwasher safe, for food presentation



Art-Nr. Part No.	Länge Length cm	Breite Width cm	Höhe Height cm
3869/450	45	27	4



Art-Nr. Part No.	Länge Length cm	Fläche Size cm	Stärke Thickness cm
3864/500	50	38 x 25	2,5

Als Naturprodukt ist jede Scheibe eigen in Abmessung und Aussehen.

Being a natural product, every board is unique in terms of exact size, shape and finish.



Rindenbrett, mit Griff

natürliche Baumscheibe aus Esche mit Rinde, farblos lebensmittelecht lackiert, nicht spülmaschinengeeignet, zum Servieren von rustikalen Speisen

Ash Board

with handle, genuine ash with bark, food safe lacquered, not dishwasher safe



Art-Nr. Part No.	Größe Size cm	Stärke Thickness cm
3865/050	50 - 60	2
3865/060	60 - 70	2
3865/070	70 - 85	2

Als Naturprodukt ist jede Scheibe eigen in Abmessung und Aussehen.

Being a natural product, every board is unique in terms of exact size, shape and finish.



Rindenbrett

natürliche Baumscheibe aus Esche mit Rinde, farblos lebensmittelecht lackiert, nicht spülmaschinengeeignet, zum Servieren von rustikalen Speisen

Ash Board

genuine ash with bark, food safe lacquered, not dishwasher proof



Art-Nr. Part No.	Ø dia. cm	Stärke Thickness cm
3863/022	20 - 22	2,5
3863/026	23 - 26	2,5
3863/030	27 - 30	2,5

Als Naturprodukt ist jede Scheibe eigen in Abmessung und Aussehen.

Being a natural product, every board is unique in terms of exact size, shape and finish.



Rindenbrett, rund

natürliche Baumscheibe aus Esche mit Rinde, farblos lebensmittelecht lackiert, nicht spülmaschinengeeignet, zum Servieren von rustikalen Speisen

Round Ash Board

genuine ash with bark, food safe lacquered, not dishwasher safe



Art-Nr. Part No.	Ø dia. cm	Länge gesamt Total Length cm
3866/320	32	43



Flammkuchenbrett, rund

aus 8 mm starkem Birkenholz, mehrfach verleimt, mit Griff, nicht spülmaschinengeeignet

Birch Paddle Board

8 mm multi-layered birch wood, with handle, not dishwasher safe, ideal for serving pizza, bread etc.



Art-Nr. Part No.	Fläche Size cm	Länge gesamt Total Length cm
3867/385	30,5 x 38,5	51



Flammkuchenbrett, eckig

aus 9 mm starkem Birkenholz, mehrfach verleimt, mit Griff, nicht spülmaschinengeeignet

Birch Paddle Board

9 mm multi-layered birch wood, with handle, not dishwasher safe, ideal for serving pizza, bread etc.



Art-Nr. Part No.	Fläche Size cm	Länge Length cm
3891/500	50 x 27	60



Pizzabrett, rechteckig

aus 9 mm starkem Birkenholz, mehrfach verleimt, nicht spülmaschinengeeignet

Birch Paddle Board

9 mm multi-layered birch wood, not dishwasher safe





Buffet- & Bankettplatten

Vorhang auf. Verschaffen Sie Ihren Fingerfood-Speisen und Oeuvres die entsprechende Bühne. Ansprechend und originell angerichtet auf den Buffet- und Bankettplatten von **contacto**.

Buffet & Banqueting Trays

Make a statement. Use these trays to turn the special into the divine.

Das VDN-System erlaubt beliebige Kombinationen von Formen auf dem Buffet. Zudem können bis zu vier Höhenebenen geschaffen werden.

Lassen Sie Ihren Ideen freien Lauf um Ihr Fingerfood von asiatisch bis zu mediterran appetitlich und kreativ anzubieten. Mit den Buffetplatten von **contacto** lässt sich alles umsetzen.

This VDN system gives you a number of options for your buffet in up to four different heights.

*Let your ideas run free to offer anything from Asian to Mediterranean in a creative and appetizing way. With the choice you have from **contacto** anything's possible!*



- Edelstahl 18/10
- hochglänzend
- vier Höhenebenen
- Formen kombinierbar
- schwere Qualität

- 18/10 stainless steel
- mirror polished
- four height levels
- can be combined
- heavy gauge

Buffet Modulsystem VOLLKREIS

aus 1,5 mm starkem Edelstahl 18/10, hochglänzend, auf drei bzw. vier Gummifüßen

Circular Buffet Display

1.5 mm thick 18/10 stainless steel, mirror polished finish, with three/four rubber feet



Art-Nr. Part No.	Ø dia.
auf 3 Füßen / with three feet	
2502/420	42 cm
2502/500	50 cm
auf 4 Füßen / with four feet	
2502/600	60 cm

Buffet Modulsystem HALBMOND

aus 1,5 mm starkem Edelstahl 18/10, hochglänzend, auf drei Gummifüßen

Crescent Buffet Display

1.5 mm thick 18/10 stainless steel, mirror polished finish, with three rubber feet



Art-Nr. Part No.	Ø dia.
2501/500	50 cm

Buffet Modulsystem VIERTELKREIS

aus 1,5 mm starkem Edelstahl 18/10, hochglänzend, auf vier Gummifüßen

Quarter Circle Buffet Display

1.5 mm thick 18/10 stainless steel, mirror polished finish, with four rubber feet



Art-Nr. Part No.	Länge Length	Breite Width
2504/400	40 cm	40 cm



Art-Nr.	Größe
Part No.	Size
2506/400	40 cm x 40 cm



Buffet Modulsystem QUADRAT

aus 1,5 mm starkem Edelstahl 18/10, hochglänzend, auf vier Gummifüßen

Square Buffet Display

1.5 mm thick 18/10 stainless steel, mirror polished finish, with four rubber feet

Art-Nr.	Länge	Breite
Part No.	Length	Width
2503/480	48 cm	40 cm
2503/600	60 cm	50 cm



Buffet Modulsystem RECHTECK, kassettiert

aus 1,5 mm starkem Edelstahl 18/10, hochglänzend, auf vier Gummifüßen

Rectangular Buffet Display

1.5 mm thick 18/10 stainless steel, mirror polished finish, with four rubber feet

Art-Nr.	Länge	Breite
Part No.	Length	Width
2505/400	40 cm	40 cm



Buffet Modulsystem DREIECK

aus 1,5 mm starkem Edelstahl 18/10, hochglänzend, auf drei Gummifüßen

Triangular Buffet Display

1.5 mm thick 18/10 stainless steel, mirror polished finish, with three rubber feet

Art-Nr.	Länge	Breite	Anzahl Löcher	∅ Loch
Part No.	Length	Width	Number holes	∅ Hole
	cm	cm		cm
1140/020	36	24	21	2
1140/030	36	24	11	3

Drei Füße aus Edelstahl 18/0 zum Hochstellen einer Palette bitte separat bestellen: / Please order set of three 18/0 stainless steel feet separately for each palette:

2509/050	5
2509/100	10
2509/150	15



Malerpalette

aus Edelstahl 18/10, mit Griffloch zum Tragen oder Servieren von Eishörnchen, Mini-Eishörnchen oder Mini-Wraps, mit drei angeschraubten Gummifüßen, die Füße können durch Hochsteller ersetzt werden,

Cornet Stand

18/10 stainless steel, with large hole, three short rubber feet, can be replaced with taller feet, for ice cream

Art-Nr.	Länge
Part No.	Length
2509/050	5 cm
2509/100	10 cm
2509/150	15 cm

Preis pro Stück.
Priced per each leg.



Hochsteller für Buffet Modulsystem

aus massivem Edelstahl 18/0, zum Aufschrauben anstelle der Gummifüße, passend für alle Module, wahlweise in drei Höhen

Feet for Buffet Display System

solid 18/0 stainless steel, to be screwed, available in three heights

Bratenplatte, oval

aus Edelstahl 18/10, seidenmatt poliert, tiefe Form, mit gebördeltem Rand, schwere Qualität

Oval Meat Flat

18/10 stainless steel, satin polished finish, rolled edge, heavy gauge

18/10
EDELSTAHL
STAINLESS STEEL



Art-Nr. Part No.	Länge Length cm	Breite Width cm	Höhe Height cm
1/260	26	19	2
1/310	31	21,5	2,2
1/360	36	25	2,7
1/420	42	28,5	3
1/470	47	31	3
1/510	51	34	3,3
1/565	56,5	38	3,5
1/635	63,5	41	3,5

Bratenplatte, oval, flach

aus Edelstahl, hochglänzend, flache Form, mit gebördeltem Rand

Oval Meat Flat

stainless steel, mirror polished finish, with rolled edge

INOX
EDELSTAHL
STAINLESS STEEL



Art-Nr. Part No.	Länge Length cm	Breite Width cm	Höhe Height cm
3/250	25	18	1,6
3/300	30	22	1,8
3/350	35	22	1,6
3/400	40	26	2
3/450	45	29	2
3/500	50	35	2,4
3/550	55	38	3
3/610	60,5	42	3
3/660	66	46	3,2

Bratenplatte

aus Edelstahl 18/10, Innenfläche seidenmatt gebürstet, mit hochglänzendem, gebördeltem Rand, schwere Qualität

Meat Flat

18/10 stainless steel, satin polished with mirror polished rolled edge, heavy gauge

18/10
EDELSTAHL
STAINLESS STEEL



Art-Nr. Part No.	Länge Length cm	Breite Width cm	Höhe Height cm
1441/370	37	26	2
1441/530	53	36	2

Bratenplatte, rund

aus Edelstahl, mit gebördeltem Rand, seidenmatt poliert, schwere Qualität

Round Platter

stainless steel, satin polished finish, with rolled edge, heavy gauge

INOX
EDELSTAHL
STAINLESS STEEL



Art-Nr. Part No.	∅ dia. cm	Höhe Height cm
4/200	21 cm	1,2 cm

Tablett, rund

ganz aus Edelstahl 18/10, hochglänzend poliert

Round Buffet Tray

18/10 stainless steel, mirror polished

18/10
EDELSTAHL
STAINLESS STEEL



Art-Nr. Part No.	∅ dia. cm	Höhe Height cm
3835/450	46	2



Art-Nr. Part No.	Länge Length cm	Breite Width cm	Höhe Height cm
6/380	38	27	1,8
6/430	43	30	1,8
6/480	48,5	33,5	1,8
6/550	55	38	1,8



Tablett

ohne Griffe, rechteckig, aus Edelstahl 18/10, mit verziertem, hochglänzendem Rand, Bodenfläche seidenmatt, schwere Qualität

Tray

18/10 stainless steel, satin polished finish, with decorated, mirror polished edge, heavy gauge



Art-Nr. Part No.	Länge Length cm	Breite Width cm	Höhe Height cm
7/430	43	30	1,8
7/480	48	35,5	1,8
7/550	55	38	1,8

(Längen ohne Griffe gemessen)
(Length excludes handles)



Tablett

mit Griffen, rechteckig, aus Edelstahl 18/10, mit verziertem, hochglänzendem Rand, Bodenfläche seidenmatt, schwere Qualität

Tray

with handles, 18/10 stainless steel, satin polished finish with decorated, mirror polished edge, heavy gauge



Art-Nr. Part No.	Länge Length cm	Breite Width cm	Höhe Height cm
8/300	30	23,5	1,6
8/350	35	27	1,8
8/400	40	29,5	2
8/450	45	34,5	2,2
8/500	52	40	3
8/600	60	46	3,2



Barocktablett

ohne Griffe, rechteckig, aus Edelstahl 18/10, hochglänzend

Baroque Tray

18/10 stainless steel, mirror polished finish



Art-Nr. Part No.	Länge Length cm	Breite Width cm	Höhe Height cm
9/520	52	40	3

(Längen ohne Griffe gemessen)
(Length excludes handles)



Barocktablett

mit Griffen, rechteckig, aus Edelstahl 18/10, hochglänzend

Baroque Tray

with handles, 18/10 stainless steel, mirror polished finish



Art-Nr. Part No.	Länge Length cm	Breite Width cm	Höhe Height cm
10/300	31	24	1,8
10/350	37	29	1,6
10/450	47	36	2



Barocktablett

ohne Griffe, oval, aus Edelstahl 18/10, hochglänzend

Oval Baroque Tray

18/10 stainless steel, mirror polished finish



Art-Nr. Part No.	Länge Length cm	Breite Width cm	Höhe Height cm
1440/250	25	19,5	2
1440/310	31	23,5	2,3
1440/370	37	27	2,4
1440/440	41	31,5	2,4
1440/500	46	35	2,4



Platte, achteckig

aus Edelstahl 18/10, hochglänzend, schwere Qualität

Display/Service Tray

18/10 stainless steel, mirror polished finish, heavy gauge



Bankettplatte, rechteckig

aus 1,5 mm starkem Edelstahl 18/10, hochglänzend, glatt auslaufender Rand, extra schwere Qualität

Rectangular Buffet Tray

1.5 mm thick 18/10 stainless steel, mirror polished finish, with open edge, extra heavy gauge



Art-Nr. Part No.	Länge Length cm	Breite Width cm	Höhe Height cm
6910/065	65	44	2
6910/075	75	50	2
6910/082	82	50	2
6910/100	100	65	2

GN-Bankettplatte

aus 1,5 mm starkem Edelstahl 18/10, hochglänzend, glatt auslaufender Rand, extra schwere Qualität

GN Buffet Tray

1.5 mm thick 18/10 stainless steel, mirror polished finish, with open edge, extra heavy gauge



Art-Nr. Part No.	Länge Length cm	Breite Width cm	Höhe Height cm	GN
6911/530	53	32,5	2	1/1
6921/650	65	53	2	2/1

Buffet-Platte, oval

aus Edelstahl 18/10, gebördelter Rand, schwere Qualität

Oval Buffet Tray

18/10 stainless steel, with rolled edge, heavy gauge



Art-Nr. Part No.	Länge Length cm	Breite Width cm	Höhe Height cm
6901/360	36	25	2,5
6901/420	42	28,5	2,5
6901/510	51	34	2,5

Bankettplatte, oval

aus 1,5 mm starkem Edelstahl 18/10, hochglänzend, glatt auslaufender Rand, extra schwere Qualität

Oval Buffet Tray

1.5 mm thick 18/10 stainless steel, mirror polished finish, with open edge, extra heavy gauge



Art-Nr. Part No.	Länge Length cm	Breite Width cm	Höhe Height cm
6908/345	34,5	26	2
6908/400	40	29,5	2
6908/460	46	33,5	2
6908/520	52	36,5	2
6908/560	56	40	2
6908/620	62	43,5	2
6908/700	70	48	2

Bankettplatte, rund

aus 1,5 mm starkem Edelstahl 18/10, hochglänzend, glatt auslaufender Rand, extra schwere Qualität

Round Buffet Tray

1.5 mm thick 18/10 stainless steel, mirror polished finish, with open edge, extra heavy gauge



Art-Nr. Part No.	∅ dia. cm	Höhe Height cm
6905/320	32	2
6905/400	40	2
6905/500	50	2
6905/600	60	2
6905/800	80	2



Art-Nr. Part No.	Länge Length cm	Breite Width cm	Höhe Height cm
1449/655	66	50	2,6

(Längen ohne Griffe gemessen)
(Length excludes handles)



Buffet-Tablett

aus 1,5 mm starkem Edelstahl 18/10, hochglänzend, mit offenem Rand, mit Hohlgriffen, schwere Qualität

Banqueting Tray

1.5 mm thick 18/10 stainless steel, mirror polished finish, with spot welded and silver soldered hollow handles, open edge, heavy gauge



Art-Nr. Part No.	Länge Length cm	Breite Width cm	Höhe Height cm
950/350	35	27	1,6
950/400	40	30	2
950/450	45	34	2
950/520	52	39	2
950/600	60	45	2

(Längen ohne Griffe gemessen)
(Length excludes handles)



Tablett, rechteckig

aus Edelstahl 18/10, seidenmatt glänzend, mit Griffen, aus einem Stück gefertigt

Service Tray

18/10 stainless steel, satin polished finish, one piece with handles, heavy gauge



Art-Nr. Part No.	Länge Length cm	Breite Width cm	Höhe Height cm
51/220	22	17	2
51/260	26	20	2
51/310	31	24	2
51/340	34	26	2
51/370	36,5	28	2
51/420	42	32	2
51/470	47	36,5	2
51/520	52	40	2
51/600	60	47	2,4

(Längen ohne Griffe gemessen)
(Length excludes handles)



Tablett

aus Edelstahl 18/10, mit gebördeltem Rand

Display Tray

18/10 stainless steel, with rolled edge



Art-Nr. Part No.	Länge außen Outer Length cm	Breite außen Outer Width cm	Höhe Height cm
5401/210	21	16	1
5401/240	24	18	1
5401/280	28	21	0,6
5401/300	31	16	1
5401/305	30,5	23	1
5401/310	31	21	1
5401/350	33	25	1
5401/351	35	25	1,2
5401/420	42	28	1,2
5401/421	42	19	0,6

(Längen ohne Griffe gemessen)
(Length excludes handles)



Ausstelltablett

aus Edelstahl 18/10, hochglänzend, mit offen gebördeltem Rand

Display / Butcher's Tray

18/10 stainless steel, satin polished finish, with half rolled edge



Auslagentablett

aus Edelstahl 18/10, matt poliert,
mit abgerundeten Ecken

Display/Butcher's Tray

18/10 stainless steel, satin polished, rounded corners



18/10
EDELSTAHL
STAINLESS STEEL

Art-Nr. Part No.	Länge Length cm	Breite Width cm	Höhe Height cm
5406/260	26	18	2,5

Auslagentablett

aus Edelstahl 18/10, hochglänzend mit offenem,
glattem Rand, schwere Qualität

Display Tray

18/10 stainless steel, mirror polished finish,
with open, flat edge, heavy gauge



18/10
EDELSTAHL
STAINLESS STEEL

Art-Nr. Part No.	Länge Length cm	Breite Width cm	Höhe Height cm
290/210	21	14,5	2

Seidenmatt poliert: / Satin polished finish:

Hochglänzend poliert: / Mirror polished finish:

290/290	29	21	2
290/400	40	30	2
290/580	58	21	2
290/581	58,5	40,5	2

Auslagentablett

aus Edelstahl 18/10, hochglänzend,
mit gebogenem Rand

Display / Butcher's Tray

18/10 stainless steel, mirror polished finish,
with raised and half rolled edge



18/10
EDELSTAHL
STAINLESS STEEL

Art-Nr. Part No.	Länge Length cm	Breite Width cm	Höhe Height cm
5402/220	22,5	16	1,3
5402/280	28,5	18,5	1,7
5402/340	34	24,5	1,8
5402/400	38,5	27	1,8
5402/450	44	29,5	1,8
5402/500	49	32	1,8

Auslagentablett

aus Edelstahl 18/10, hochglänzend,
mit glattem Rand, schwere Qualität

Display/ Butcher's Tray

18/10 stainless steel, mirror polished finish,
with open edge, heavy gauge



18/10
EDELSTAHL
STAINLESS STEEL

Art-Nr. Part No.	Länge Length cm	Breite Width cm	Höhe Height cm
580/100	21,5	15,5	1,8

580/200	29,5	19,5	2
580/400	36	24	1
580/600	39	27	1
580/700	49	32	1,4
580/800	44,5	35	1,2
580/900	44,5	32,5	0,9

Auslageplatte, schwarz

aus Polycarbonat

Display Tray

black polycarbonate



PC
POLY-CARBONATE

SPÜLMASCHINE
TISCHWASHER

BRÜUCHSICHER
VERBODEN

Art-Nr. Part No.	Länge Length cm	Breite Width cm	Höhe Height cm
4940/300	29	19,5	2
4940/350	35	28	1,5
4940/400	40	20	1,5
4940/403	40	30	1,5
4940/600	58	19,5	2

Tablett mit Haube

aus Edelstahl 18/0, hochglänzend, Haube aus Luran®,
temperaturresistent zwischen -40°C und +95°C,
Innenfläche 34 x 23 cm

Pastry Tray with Cover

18/0 stainless steel, mirror polished finish, with Luran®
cover, can be used between -40°C and +95°C,
inner size: 34 x 23 cm



18/0
EDELSTAHL
STAINLESS STEEL

SAN
KUNSTSTOFF
PLASTIC

Art-Nr. Part No.	Länge Length cm	Breite Width cm	Höhe gesamt Overall Height cm
673/430	43	31	8,5

Ersatzhaube für 673/430: / Spare cover for 673/430
673/901



Art-Nr. Part No.	Länge Length cm	Breite Width cm	Höhe Height cm	GN
5812/325	32,5	26,5	1,5	1/2
5811/530	53	32,5	1,5	1/1



GN-Tablett mit Dekorrand

aus Edelstahl 18/0, hochglänzend, mit Dekorrand

GN Buffet Tray

18/0 stainless steel, mirror polished finish, with decorated edge



Art-Nr. Part No.	Länge Length cm	Breite Width cm	Höhe Height cm	GN
4311/530	53	32,5	1,5	1/1



GN-Tablett mit Dekorrand

aus Edelstahl, hochglänzend, mit Dekorrand

GN Buffet Tray

stainless steel, mirror polished, with decorated edge



Art-Nr. Part No.	Länge Length cm	Breite Width cm	Höhe Height cm	GN
6012/325	32,5	26,5	1,5	1/2
6011/530	53	32,5	1,5	1/1
6021/650	65	53	1,5	2/1



GN Buffet-Tablett

aus Edelstahl 18/10, seidenmatt poliert mit hochglänzendem offenem Rand, extra schwere Qualität

GN Buffet Tray

18/10 stainless steel, satin polished finish, with mirror polished edge, fits most GN 1/1 chafing dishes, trolleys and insulated transport boxes, extra heavy gauge



Art-Nr. Part No.	Länge Length cm	Breite Width cm	Höhe Height cm	GN
4711/530	53	32,5	1,5	1/1



GN Tablett

aus Edelstahl 18/10, hochglänzend

GN Buffet Tray

18/10 stainless steel, mirror polished finish



Art-Nr. Part No.	Länge Length cm	Breite Width cm	Höhe gesamt Overall Height cm
5611/530	53	32,5	5



GN Buffet-Tablett

aus Edelstahl 18/10, seidenmatt poliert, bis 3 Stück stapelbar

GN 1/1 Buffet Tray

18/10 stainless steel, satin polished finish, 3 can be stacked with or without food



Art-Nr. Part No.	Länge Length cm	Breite Width cm	Höhe Height cm	GN
657/325	32,5	26,5	12	1/2
657/530	53	32,5	8	1/1



GN Platte mit Abdeckhaube

Haube aus klarem SAN Kunststoff, flache Form mit Griffknopf, Tablett aus weißem SAN, temperaturbeständig von -40°C bis +90°C

GN Plate and Cover, shallow

clear SAN plastic cover, shallow design with knob, white SAN tray, withstands temperatures from -40°C to +90°C



GN-Rolltop Abdeckhaube

Haube und Griff aus glasklarem Polycarbonat, temperaturbeständig bis +65°C, geeignet für den Einsatz auf GN 1/1 Chafing Dishes, sehr robuste Qualität, nahezu unzerbrechlich

GN 1/1 Rolltop Buffet Lid

clear polycarbonate, temperature resistant up to +65°C, fits GN 1/1 containers in chafing dishes, heavy gauge, virtually unbreakable



Art-Nr. Part No.	Länge außen Outer Length cm	Breite außen Outer Width cm	Höhe Height cm	GN
645/530	54	33,5	19	1/1

GN-Kuppelhaube

aus glasklarem Polycarbonat mit verchromtem Griff, passt auf alle GN-Tabletts, stapelbar, bis +65°C einsetzbar, sehr robuste Qualität, nahezu unzerbrechlich

GN 1/1 Buffet Cover

clear polycarbonate, fits on all GN 1/1 trays, stackable, temperature resistant up to +65°C, heavy gauge, virtually unbreakable



Art-Nr. Part No.	Länge außen Outer Length cm	Breite außen Outer Width cm	Höhe Height cm	GN
647/530	54	33,3	16	1/1

GN-Kuppelhaube

aus glasklarem Polycarbonat mit verchromtem Griff, stapelbar, passt auf alle GN-Tabletts, mit Öffnung an Längsseite, bis +65°C einsetzbar, sehr robuste Qualität, nahezu unzerbrechlich

GN 1/1 Buffet Cover

clear polycarbonate, fits on all GN 1/1 trays, open one side for serving, stackable, temperature resistant up to +65°C, heavy gauge, virtually unbreakable



Art-Nr. Part No.	Länge außen Outer Length cm	Breite außen Outer Width cm	Höhe Height cm	GN
648/530	54	33,3	16	1/1

GN-Buffethaube

aus glasklarem Polycarbonat, passt auf alle GN-Tabletts, wechselseitig eine Hälfte ganz aufklappbar, stapelbar, bis +65°C einsetzbar, sehr robuste Qualität, nahezu unzerbrechlich

GN 1/1 Buffet Cover

clear polycarbonate, fits GN 1/1 trays, half section can be completely opened, stackable, temperature resistant up to +65°C, heavy gauge, virtually unbreakable



Art-Nr. Part No.	Länge außen Outer Length cm	Breite außen Outer Width cm	Höhe Height cm	GN
649/530	54	33,3	7	1/1

Rolltop Abdeckhaube, rund

aus glasklarem Polycarbonat, temperaturbeständig bis +65°C, geeignet für den Einsatz auf Chafing Dishes mit 40 cm Durchmesser, sehr robuste Qualität, nahezu unzerbrechlich

Rolltop Buffet Lid, round

clear polycarbonate, temperature resistant up to +65°C, heavy gauge, virtually unbreakable



Art-Nr. Part No.	∅ dia. cm	Höhe Height cm
646/400	40	23

Gedeckter Tisch

Sei es für die Kaffeetafel oder für das 4-Gänge Menu - mit dem richtigen Besteck und besonderen Extras lassen Sie den Anlass noch festlicher und geschmackvoller wirken. Die Tischaccessoires machen aus einem Tisch eine einladend gedeckte Tafel. Auf den nächsten Seiten finden Sie alles für ein stimmiges Ambiente.

Tableware

*From casual to fine dining, eating out should be fun and interesting.
Create occasions to remember with great presentation items and tableware.*

Seite Page
324

Serviergeschirr, modern
Baskets, Boards & Buckets



Seite Page
330

Serviergeschirr, Kupfer
Mini Copperware



Seite Page
332

Serviergeschirr, Edelstahl
Mini Stainless Steel



Seite Page
334

Serviergeschirr, klassisch
Classic Dining



Seite Page
342

Besteck
Cutlery



Seite Page
354

Steak- & Spezialbesteck
Steak & Assorted Cutlery



Seite Page
358

Menagen & Mühlen
Condiments & Mills



Seite Page
370

Honig, Zucker & Sahne
Honey, Sugar & Cream

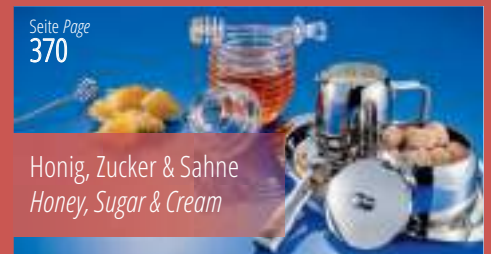

Serviergeschirr, modern

Inszenieren Sie Ihre Speisen. Die originellen und außergewöhnlichen Serviergeschirre von **contacto** setzen Trends. Sie verleihen Ihren Gerichten das gewisse Etwas.

Baskets, Boards & Buckets

Casual dining. Small is still beautiful making good food look great.

Servier-Frittierkorb, rund

aus Edelstahl 18/10, insbesondere zum originellen Servieren von Beilagen geeignet, aber auch zum Frittieren selbst, spülmaschinene geeignet, schwere Qualität

Small Round Basket

18/10 stainless steel, for frying and serving chips etc., dishwasher safe, heavy gauge

18/10
EDELSTAHL
STAINLESS STEEL



Art-Nr. Part No.	Ø dia. cm	Höhe Height cm	Stiellänge Handle Length cm
1146/090	8,5	7,5	10

Servier-Frittierkorb, eckig

aus Edelstahl, insbesondere zum originellen Servieren von Beilagen wie Pommes frites geeignet, aber auch zum Frittieren selbst, spülmaschinene geeignet, schwere Qualität

Small Rectangular Basket

stainless steel, for frying and serving chips etc., dishwasher safe, heavy gauge

INOX
EDELSTAHL
STAINLESS STEEL



Art-Nr. Part No.	Länge Length cm	Breite Width cm	Höhe Height cm	Stiellänge Handle Length cm
1147/100	10	8	7	9,5

Servier-Frittierkorb, flach

aus Edelstahl, insbesondere zum originellen Servieren von Beilagen oder Bratwurst geeignet, aber auch zum Frittieren selbst, spülmaschinene geeignet, schwere Qualität

Small Shallow Basket

stainless steel, for serving fish & chips etc., dishwasher safe, heavy gauge

INOX
EDELSTAHL
STAINLESS STEEL



Art-Nr. Part No.	Länge Length cm	Breite Width cm	Höhe Height cm	Stiellänge Handle Length cm
1149/215	21,5	10,5	3,5	10,5

Art-Nr. Part No.	∅ oben ∅ Top cm	Höhe Height cm
1148/110	12,5	22



Pommes frites-Tüthenhalter

aus 5 mm starkem verchromten Stahldraht, mit weißem Porzellaninsert, Einsatz spülmaschinengeeignet

Chip Cone

5 mm chrome plated steel wire, white porcelain insert, insert dishwasher safe



Art-Nr. Part No.	∅ dia. cm	Höhe Height cm
1141/180	9	16



Pommes frites-Tüthenhalter

aus Edelstahl, zum Servieren von Pommes frites in Papiertüten

Chip Cone Holder

stainless steel wire, for serving chips in paper cones



Hierzu passende Papiertüten (1000 Stück): /

Matching paper cones (1000 pcs):

4494/180

Art-Nr. Part No.	Länge Length cm	Breite Width cm
4494/180	25,5	18

Preis und Verpackung je 1000 Blatt.

Priced and packed per box of 1000.



Pommes frites-Tüte

spitze Form, aus fettgedichtetem Papier, bedruckt im Stil einer englischen Zeitung

Greaseproof Paper Cone

printed in newspaper style, for serving fish and chips etc.

Art-Nr. Part No.	Länge Length cm	Breite Width cm
4492/345	35	25

Lieferung in Paket zu 500 Blatt.

Priced and packed per box of 500.



Wachspapier

fettgedichtetes Papier, bedruckt im Stil einer englischen Zeitung, zum dekorativen Servieren von Speisen

Greaseproof Paper

greaseproof paper, printed in newspaper style, for serving fish and chips etc.

Art-Nr. Part No.	Länge Length cm	Breite Width cm
4493/359	35	25

Lieferung in Paket zu 500 Blatt.

Priced and packed per box of 500.



Wachspapier KARO

fettgedichtetes Papier, mit Karomuster, zum dekorativen Servieren von Speisen

Greaseproof Paper Gingham

greaseproof paper, with check pattern, for decorative serving of food

Dip Set

aus Akazienholz, tiefe Mulde 18 x 8 cm für Tapas,
mit Dipschälchen 7 x 2 cm aus weißem Porzellan

Acacia Wood Dip Set

natural acacia wood, mould for tapas 18 x 8 cm,
with white porcelain Ø 7 x 2 cm dia. bowl



Art-Nr. Part No.	Länge Length cm	Breite Width cm	Höhe Height cm
---------------------	-----------------------	-----------------------	----------------------

3870/300 30 10 3,5

Bitte beachten Sie unsere Pflegehinweise zu Holzwaren.

Ersatzschalen auf Anfrage erhältlich.

Please follow our care instructions for wooden products.

Spare bowls available on request.

Dip Set

aus Akazienholz, mit Dipschälchen 6 x 3 cm
aus weißem Porzellan

Acacia Board Dip Set

natural acacia wood, with white porcelain Ø 6 x 3 cm
dia. bowl



Art-Nr. Part No.	Länge Length cm	Breite Width cm	Stärke Thickness cm
---------------------	-----------------------	-----------------------	---------------------------

3871/360 36 18 1,5

Bitte beachten Sie unsere Pflegehinweise zu Holzwaren.

Ersatzschalen auf Anfrage erhältlich.

Please follow our care instructions for wooden products.

Spare bowls available on request.

Dip Set

aus Akazienholz, mit Dipschälchen 6 x 3 cm
aus weißem Porzellan

Acacia Board Dip Set

natural acacia wood, with white porcelain Ø 6 x 3 cm
dia. bowl



Art-Nr. Part No.	Länge Length cm	Breite Width cm	Stärke Thickness cm
---------------------	-----------------------	-----------------------	---------------------------

3872/365 36 25 1,5

Bitte beachten Sie unsere Pflegehinweise zu Holzwaren.

Ersatzschalen auf Anfrage erhältlich.

Please follow our care instructions for wooden products.

Spare bowls available on request.

Dip Set

aus Akazienholz, mit drei Dipschälchen 8 x 3 cm
aus weißem Porzellan

Acacia Wood Dip Set

natural acacia wood, with white porcelain Ø 8 x 3 cm
dia. bowls



Art-Nr. Part No.	Länge Length cm	Breite Width cm	Dicke Thickness cm
---------------------	-----------------------	-----------------------	--------------------------

3874/340 34 14,5 1,5

Bitte beachten Sie unsere Pflegehinweise zu Holzwaren.

Ersatzschalen auf Anfrage erhältlich.

Please follow our care instructions for wooden products.

Spare bowls available on request.

Holzbrett

aus massiver Eiche, geölt

Oak Board

heavy oak, oiled



Art-Nr. Part No.	Länge Length cm	Breite Width cm	Stärke Thickness cm
---------------------	-----------------------	-----------------------	---------------------------

3857/570 58 26 2

Maße können materialbedingt abweichen.

Dimensions might vary due to material.

Art-Nr. Part No.	Länge Length cm	Breite Width cm	Höhe Height cm
naturfarben: / natural:			
3898/150	15	9	2
3898/200	20	13	3,5
3898/400	40	15	3,5
3898/350	35	20	3,5



Mini-Holzpalette

aus unbehandeltem Holz, lebensmittelgeeignet, nicht spülmaschinengeeignet, zum dekorativen Servieren

Mini Wooden Pallet

natural wood, food safe, for presentation and serving of food, not dishwasher safe



Art-Nr. Part No.	Länge Length cm	Breite Width cm	Höhe Height cm
3898/201	20	13	3,5

Hinweis: Lebensmittel nicht direkt auf dem Holz servieren. Bitte nutzen Sie beispielsweise unser Trennpapier 4493 von Seite 325. Do not use in direct contact with food. Please use paper 4493 on page 325 for example.



Mini-Holzpalette

aus grau lasiertem Holz, zum dekorativen Servieren

Mini Wooden Pallet

grey varnished wood, for presentation and serving of food



Art-Nr. Part No.	Länge innen Inner Length cm	Breite innen Inner Width cm	Höhe innen Inner Height cm
1176/145	14	10	5
1176/185	17,5	12,5	8



Mini-Einkaufskorb

aus verchromtem Draht, Handgriff mit schwarzem PVC beschichtet, zum originellen Servieren von Speisen

Mini Shopping Basket

chrome plated wire, black PVC coated handle, for serving food



Art-Nr. Part No.	Länge Length cm	Breite Width cm	Höhe Height cm
2736/300	30	8,5	4
2736/450	45	13	6



Offene Sektflasche

aus grünem Glas, längsseitig halbiert, handgefertigt, zum Servieren von Speisen

Snack Dish

champagne glass bottle, cut lengthway, hand made



Art-Nr. Part No.	∅ dia. cm	Höhe Height cm
1174/085	8,5	6



Mini-Seiher

aus Edelstahl, hochglänzend poliert

Mini Colander

stainless steel, mirror polished finish



Servier-Becher

aus Edelstahl, gehämmerte Oberfläche

Mini Serving Cup

stainless steel, hammered



Art-Nr. Part No.	∅ dia. cm	Höhe Height cm
1439/085	8,5	8,5

Servier-Eimer

mit Bügel, aus Edelstahl, hochglänzend poliert, zum Servieren von beispielsweise Pommes frites

Mini Bucket

with handle, stainless steel, mirror polish finished, for serving chips etc.



Art-Nr. Part No.	∅ oben ∅ Top cm	Höhe Height cm	
1436/090	8,5	8,5	0,33 l

Mini-Eimer aus Porzellan

aus weißem Porzellan, mit Bügel aus Edelstahldraht, lebensmittelgeeignet, spülmaschinene geeignet

Mini Bucket

white porcelain, with stainless steel wire handle, food and dishwasher safe



Art-Nr. Part No.	∅ oben ∅ Top cm	Höhe Height cm	
2751/012	7	6	115 ml
2751/050	10	10	500 ml
2751/075	11	13	750 ml

Mini-Eimer für Saucen

aus Edelstahl 18/10, hochglänzend poliert, zum Servieren von Ketchup- und anderen Saucen-Portionen

Mini Sauce Bucket

18/10 stainless steel with handle, mirror polished finish, for serving sauces etc.



Art-Nr. Part No.		∅ oben ∅ Top cm	Höhe Height cm
1435/075	75 ml	6	5

Serviergestell mit Sauceneimern

Menagengestell aus Edelstahl 18/0, mit zwei Serviereimern Art. 1435/075 aus Edelstahl 18/10, zum Servieren von Ketchup- und anderen Saucen-Portionen

Mini Sauce Buckets Set

18/0 stainless steel wire, with two 18/10 stainless steel 1435/075 mini sauce buckets, for serving sauces, ketchup etc.



Art-Nr. Part No.	Höhe Height cm	Breite Width cm
1437/002	10,5	9

Marmeladenglas

aus glattem geblasenem Glas, mit dichtem weißem Schraubdeckel

Jam Pot

plain blown glass, with sealed white screw fitting lid



Art-Nr. Part No.	∅ außen ∅ Outside cm	Höhe Height cm	VPE carton qty
2740/050	4,5	5,3	50 ml 8
2740/901	Deckel, weiß / white lid		
2740/903	Deckel rot/weiß / red-white lid		
2740/909	Deckel goldfarben / gold coloured lid		

Preise je Verpackungseinheit.
Priced per carton quantity.

Art-Nr. Part No.	Länge Length cm	Breite Width cm	Höhe Height cm	Farbe Colour
6622/200	19,5	11,5	3,5	weiß/white



Pommes frites-Schale

aus Polypropylen, mikrowellen- und spülmaschinen-geeignet, zum stilechten Servieren von Pommes frites

Chips / French Fries Dish

polypropylene, microwave and dishwasher proof



Art-Nr. Part No.	Länge Length cm	Breite Width cm	Höhe Height cm
6623/190	19	13,5	3,5



Currywurstschale

aus weißem Polypropylen, mikrowellen- und spülmaschinengeeignet, zum stilechten Servieren von Currywurst oder Pommes frites

Hot Dog Dish

white polypropylene, microwave and dishwasher proof



Art-Nr. Part No.	∅ innen ∅ Inside cm	Höhe Height cm	Farbe Colour	
5731/100	0,25 l	9	4	schwarz/black
5731/105	0,25 l	9	4	rot/red



Mini-Cocotte, rund

aus Eisenguss, induktionsgeeignet, innen cremefarben, außen farbig emailliert, Deckel mit Edelstahlknopf

Mini Cocotte

enamelled cast iron, black with cream inside, lid with stainless steel knob on lid, suitable for induction



Art-Nr. Part No.	Größe Size cm	Höhe Height cm	
5733/120	0,3 l	12 x 8,5	4,5



Mini-Cocotte, oval

aus Eisenguss, induktionsgeeignet, innen cremefarben, außen schwarz emailliert, Deckel mit Edelstahlknopf

Mini Cocotte

enamelled cast iron, black with cream inside, lid with stainless steel knob, suitable for induction



Art-Nr. Part No.	Länge Length cm	Breite Width cm	Höhe Height cm	
4031/105	10,5	6,5	3	0,125 l

Verpackung und Preis à 10 Stück.
Packed and priced in 10s.



Konservendose, oval

mit lose aufliegendem Deckel, aus beschichtetem Stahlblech, zum originellen Servieren von Snacks oder Tapas

Oval Tin

with loose lid, coated steel, for original presentation of tapas or nuts etc.



Art-Nr. Part No.	∅ dia. cm	Höhe Height cm	
4030/085	8,5	4	0,2 l

Verpackung und Preis à 10 Stück.
Packed and priced in 10s.



Konservendose, rund

mit lose aufliegendem Deckel, aus beschichtetem Stahlblech, zum originellen Servieren von Snacks oder Tapas

Round Tin

with loose lid, coated steel, for original presentation of tapas or nuts etc.



Serviergeschirr, Kupfer

Servieren Sie Ihre Speisen im hochwertigen Kupfergeschirr. Die Töpfe und Pfannen sehen nicht nur edel aus, sie sind auch hervorragende Kochgeschirre.

Mini Copperware

Present your dishes in these attractive heavy gauge copper pans to give them an added extra that just oozes quality.

Die Töpfe und Pfannen sind von schwerer Qualität und bestehen aus 1,5 mm starkem Kupfer und einer Innenwand von 0,7 mm Edelstahl 18/10, die es für alle Lebensmittel verwendbar macht. Das Geschirr ist nicht induktionsgeeignet. Die genieteten Stielgriffe bestehen aus Messing. Originell zum Servieren verschiedener Speisen und Gerichte.

These highly polished pots and pans are of a heavy quality and consist of 1.5 mm thick copper and a 0.7 mm 18/10 stainless steel lining, which makes them suitable for all food.

The riveted handles and knobs are made of brass. This range is designed for presentation and service, rather than cooking, and is not suitable for induction.



- 1,5 mm Kupfer
- 0,7 mm Edelstahl
- hochglänzend
- Messinggriffe
- edles Design
- schwere Qualität

- 1,5 mm copper
- 0,7 mm stainless steel
- riveted brass handles and knobs
- stylish design
- heavy quality
- ideal for presentation

Servierpfanne aus Kupfer

Mini Copper Frying Pan



Art-Nr. Part No.	∅ innen ∅ Inside cm	Höhe Height cm	Stiellänge Handle Length cm
8772/120	12	3,5	11

Paellapfanne aus Kupfer

Rand gebördelt, originell zum Servieren von Paella

Mini Copper Paella/Egg Pan

rolled rim, ideal for presentation



Art-Nr. Part No.	∅ innen ∅ Inside cm	Höhe Height cm	Stiellänge Handle Length cm
8766/120	12	2,5	0,2 l



Art-Nr. Part No.	∅ innen ∅ Inside cm	Höhe Height cm	
8768/090	8,5	6	0,33 l
8768/120	12	7,5	0,75 l



Cocotte aus Kupfer
Mini Copper Casserole

Art-Nr. Part No.	∅ innen ∅ Inside cm	Höhe Height cm	Stiellänge Handle Length cm	
8767/110	11	5,2	11	0,33 l
8767/140	14	5,8	11	0,6 l



Wok aus Kupfer
Rand gebördelt, originell zum Servieren von asiatischen Speisen
Mini Copper Wok
rolled rim, ideal for presentation

Art-Nr. Part No.	∅ innen ∅ Inside cm	Höhe Height cm	Stiellänge Handle Length cm	
8771/070	6,5	4,5	7	0,15 l
8771/090	8,5	6	8,5	0,33 l
8771/120	12	7,5	11	0,75 l



Stielkasserolle aus Kupfer
Mini Copper Sauce Pan

Art-Nr. Part No.	∅ innen ∅ Inside cm	Höhe Height cm	Stiellänge Handle Length cm	
8770/050	5	3	7	0,05 l
8770/090	8,5	4,5	7	0,25 l



Stielkasserolle aus Kupfer
Mini Copper Sauté Pan

Art-Nr. Part No.	∅ dia. cm	
8769/090	8,5	
8769/120	12	



Deckel aus Kupfer
Rand gebördelt, Unterseite aus 0,7 mm Edelstahl 18/10, mit Messingknopf
Mini Copper Lid
rolled rim, with 0.7 mm 18/10 mirror polished stainless steel lining, brass knob

Serviergeschirr, Edelstahl

Die hochglanzpolierten Mini-Töpfe und Pfannen werden der Hingucker auf dem Tisch sein. Präsentieren Sie Ihre Gerichte mit Stil.

Mini Stainless Steel

These highly polished mini pots and pans will be the eye catcher on the table. Present your dishes in style.

Das Geschirr ist aus 1,2 mm starken Edelstahl gefertigt. Der genietete Messinggriff verleiht den Töpfen und Pfannen eine besondere Optik. Eine ideale Möglichkeit, Gerichte zu präsentieren. Das Geschirr ist nicht induktionsgeeignet.

This range is made of 1.2 mm stainless steel. The riveted brass handles give the pots and pans a special look. An ideal opportunity to present your dishes. This range is designed for presentation and service, rather than cooking, and is not suitable for induction.



- 1,2 mm Edelstahl
- hochglänzend
- Messinggriffe
- nicht spülmaschinengeeignet

- 1,2 mm stainless steel
- mirror polished
- brass handles
- not dishwasher safe
- ideal for presentation

Stielkasserolle, flach

Mini Sauté Pan



Art-Nr. Part No.	∅ innen ∅ Inside cm	Höhe Height cm		Stiellänge Handle Length cm
3390/050	5	3	0,05 l	7
3390/090	8,5	4,5	0,25 l	7

Stielkasserolle, tief

Mini Sauce Pan



Art-Nr. Part No.	∅ innen ∅ Inside cm	Höhe Height cm		Stiellänge Handle Length cm
3391/070	6,5	4,5	0,15 l	7
3391/090	8,5	6	0,33 l	8,5
3391/120	12	7,5	0,75 l	11

Mini-Kochgeschirr

Mini Presentation Pans



Art-Nr. Part No.	∅ innen ∅ Inside cm	Höhe Height cm		Stiellänge Handle Length cm
3397/110	11	5,2	0,33 l	11
3397/140	14	5,5	0,6 l	11



Mini-Wok
Rand gebördelt

Mini Wok
rolled rim

Art-Nr. Part No.	∅ innen ∅ Inside cm	Höhe Height cm		Stiellänge Handle Length cm
3392/120	12	3,5	0,35 l	11



Mini-Bratpfanne

Mini Frying Pan

Art-Nr. Part No.	∅ innen ∅ Inside cm	Höhe Height cm		
3394/090	8,5	5,8	0,35 l	
3394/120	12	7,5	0,75 l	



Cocotte

Mini Casserole

Art-Nr. Part No.	∅ innen ∅ Inside cm	
3398/090	8,5	
3398/120	12	



Deckel

Rand gebördelt

Mini Lid
rolled edge

Art-Nr. Part No.	∅ dia. cm	Höhe Height cm		Stiellänge Handle Length cm
3395/070	7	5	0,15 l	7
3395/090	8,5	6	0,28 l	9



Mini-Stieltopf

Mini Sauteuse

Serviergeschirr, klassisch

Die klassischen Serviergeschirre von **contacto** sind für den Alltags Einsatz gewappnet. Widerstandsfähigkeit, Langlebigkeit und beste Oberflächenverarbeitung zeichnen sie aus.

Classic Dining

Classic high quality stainless steel meat and vegetable dishes accompanied by sauce boats will do themselves justice here.

Suppentasse, doppelwandig

aus Edelstahl 18/10, seidenmatt poliert, stapelbar, schwere Qualität

Insulated Soup Bowl

18/10 stainless steel, satin polished finish, double walled, heavy gauge



Art-Nr. Part No.		∅ innen ∅ Inside cm	Höhe Height cm
802/030	0,3 l	11	5,5

Doppelwandigen Deckel bitte separat bestellen: / Please order insulated lids separately:
812/030

Suppentasse, einwandig

aus 1 mm starkem Edelstahl 18/10, seidenmatt poliert, schwere Qualität

Soup Bowl

1 mm thick 18/10 stainless steel, satin polished finish, heavy gauge



Art-Nr. Part No.		∅ innen ∅ Inside cm	Höhe Height cm
800/040	0,3 l	11	5,5

Einwandigen Deckel bitte separat bestellen: / Please order lids separately:
810/040

Suppenteller

aus Edelstahl 18/10, hochglänzend, mit gebördeltem Rand

Shallow Soup Bowl

18/10 stainless steel, mirror polished finish, rolled edge



Art-Nr. Part No.	∅ dia.	Höhe Height
---------------------	--------	----------------

PRODUKTION
EINGESTELLT
PRODUCTION
DISCONTINUED

Bouillontasse

aus Edelstahl 18/10, hochglänzend, mit glatt auslaufendem Schüttrand

Soup Bowl

18/10 stainless steel, mirror polished finish, with open pouring edge



Art-Nr. Part No.		∅ dia. cm	Höhe Height cm
770/030	0,3 l	11,5	5,5

Russische Tasse

aus Edelstahl 18/10, hochglänzend, mit glatt auslaufendem Schüttrand

Russian Cup

18/10 stainless steel, mirror polished finish, with open pouring edge



Art-Nr. Part No.	∅ dia. cm	Höhe Height cm	Stiellänge Handle Length cm	
804/070	7	4	9	0,15 l

Suppenterrinen

Soup Tureens



contacto

Art-Nr. Part No.	∅ innen ∅ Inside cm	Höhe Height cm
4800/155	1 l	15,5
4800/190	1,5 l	19
4800/225	2,5 l	22,5
4800/250	4 l	25

Deckel bitte separat bestellen.
Please order lids separately.

Art-Nr. Part No.	passend zu Matches
4888/155	4800/155
4888/190	4800/190
4888/225	4800/225
4888/250	4800/250



Suppenterrine

aus Edelstahl 18/10, hochglänzend

Soup Tureen

18/10 stainless steel, mirror polished finish



Knopfdeckel

aus Edelstahl 18/10, mit Löffelausschnitt

Lid

18/10 stainless steel, notched for ladle



Art-Nr. Part No.	∅ innen ∅ Inside cm	Höhe gesamt Overall Height cm
1810/150	1 l	15
1810/170	1,5 l	17,5
1810/190	2,5 l	19
1810/210	3,5 l	21
1810/230	4,5 l	23

Deckel bitte separat bestellen.
Please order lids separately.

Art-Nr. Part No.	passend zu Matches
1812/150	1810/150
1812/170	1810/170
1812/190	1810/190
1812/210	1810/210
1812/230	1810/230



Suppenterrine

aus Edelstahl 18/10, hochglänzend, schwere Qualität

Soup Tureen

18/10 stainless steel, mirror polished finish, heavy gauge



Knopfdeckel

für Terrine Serie 1810, aus Edelstahl 18/10, mit Löffelausschnitt, schwere Qualität

Lid

18/10 stainless steel, mirror polished finish, notched for ladle, heavy gauge



Art-Nr. Part No.	∅ innen ∅ Inside cm	Höhe Height cm
5860/240	3,5 l	24
5860/260	4,5 l	26
5860/280	5,5 l	28

Deckel bitte separat bestellen.
Please order lids separately.

Art-Nr. Part No.	passend zu Matches
5862/240	5860/240
5862/260	5860/260
5862/280	5860/280



Suppenterrine mit Fuß

aus Edelstahl 18/10, hochglänzend, schwere Qualität

Soup Tureen

18/10 stainless steel, mirror polished finish, heavy gauge



Knopfdeckel

für Terrine Serie 5860, aus Edelstahl 18/10, hochglänzend, mit Löffelausschnitt

Lid

18/10 stainless steel, notched for ladle



Beilageschüssel, flach

aus Edelstahl, hochglänzend

Vegetable Dish

stainless steel, mirror polished finish



Knopfdeckel

aus Edelstahl, hochglänzend, ohne Löffelausschnitt

Lid

stainless steel, mirror polished finish, without notch



Art-Nr. Part No.		∅ innen ∅ Inside cm	Höhe Height cm
4640/140	0,25 l	12	3
4640/150	0,4 l	14	3,5
4640/180	0,6 l	16	3,5
4640/190	0,8 l	17	4,5
4640/200	1 l	18	4,5
4640/220	1,4 l	21	5

Deckel bitte separat bestellen.
Please order lids separately.

Art-Nr. Part No.	passend zu Matches
4644/140	4640/140
4644/150	4640/150
4644/180	4640/180
4644/200	4640/200
4644/220	4640/220

Beilageschüssel, flach

aus Edelstahl 18/10, hochglänzend poliert, schwere Qualität

Vegetable Dish

18/10 stainless steel, mirror polished finish, heavy gauge



Knopfdeckel

aus Edelstahl 18/10, hochglänzend poliert

Lid

18/10 stainless steel, mirror polished finish



Art-Nr. Part No.		∅ innen ∅ Inside cm	Höhe Height cm
6184/030	0,25 l	12	3,5
6184/040	0,4 l	13	4
6184/065	0,65 l	15	4,5
6184/085	0,85 l	17	4,5
6184/100	1,25 l	19	5
6184/120	1,4 l	19	5,5
6184/150	1,6 l	21	5,5
6184/200	2 l	22,5	5,5

Deckel bitte separat bestellen.
Please order lids separately.

Art-Nr. Part No.	passend zu Matches
6200/030	6184/030
6200/040	6184/040
6200/065	6184/065
6200/085	6184/085
6200/100	6184/100
6200/120	6184/120
6200/150	6184/150
6200/200	6184/200

Servierschüssel

aus Edelstahl 18/10, außen hochglänzend, innen seidenmatt poliert, mit gebördeltem Rand, schwere Qualität

Vegetable Dish

18/10 stainless steel, outside mirror polished, inside satin polished, rolled edge, heavy gauge



Art-Nr. Part No.		∅ innen ∅ Inside cm	Höhe Height cm
5780/160	1 l	16	7
5780/180	1,5 l	18	8
5780/220	2,5 l	22	10
5780/240	3,5 l	24	11

Servierschalen und -schüsseln

Serving Dishes



contacto

Art-Nr. Part No.		∅ innen ∅ Inside cm	Höhe Height cm
6886/180	1,5 l	18	11
6886/240	3,5 l	24	15
6886/280	5,5 l	28	18

Deckel 6899 bitte separat bestellen.
Please order lids separately (Part No. 6899)



Suppenterrine

aus Edelstahl 18/10, hochglänzend

Soup Tureen

18/10 stainless steel, mirror polished finish



Art-Nr. Part No.		∅ dia. cm	Höhe Height cm
6800/100	0,25 l	10	4
6800/120	0,5 l	12	4,5
6800/140	0,75 l	14	5,5
6800/160	1 l	16	6
6800/180	1,25 l	18	6,5
6800/220	2 l	22	6,5
6800/260	3,5 l	26	8

Deckel 6899 bitte separat bestellen.
Please order lids separately (Part No. 6899)



Beilageschale, tief

tiefe Form, aus Edelstahl 18/10, hochglänzend

Vegetable Dish

deep, 18/10 stainless steel, mirror polished finish



Art-Nr. Part No.		∅ dia. cm	Höhe Height cm
6801/140	0,5 l	14	4
6801/160	0,75 l	16	4,5
6801/180	1 l	18	5
6801/220	1,75 l	22	5
6801/240	2 l	24	5,5

Deckel 6899 bitte separat bestellen.
Please order lids separately (Part No. 6899)



Beilageschale, flach

flache Form, aus Edelstahl 18/10, hochglänzend

Vegetable Dish

shallow, 18/10 stainless steel, mirror polished finish



Art-Nr. Part No.		∅ dia. cm	Höhe Height cm
6802/220	2 l	22	6,5

Deckel 6899 bitte separat bestellen.
Please order lids separately (Part No. 6899)



Gratinform

runde zylindrische Form, aus Edelstahl 18/10, hochglänzend, backofengeeignet, schwere Qualität

Gratin Dish

cylindrical shape, 18/10 stainless steel, mirror polished finish, ovenproof, heavy gauge



Art-Nr. Part No.		∅ innen ∅ Inside cm	Höhe Height cm
6188/120	0,3 l	12	4
6188/140	0,5 l	14	5
6188/160	0,75 l	16	5,5
6188/180	1,1 l	18	7
6188/200	2 l	20	8

Keine Deckel zu den Beilageschüsseln lieferbar.
No lids available for these vegetable dishes.



Beilageschüssel

aus Edelstahl 18/10, seidenmatt poliert, mit geformten Lappengriffen, schwere Qualität

Vegetable Dish

18/10 stainless steel, satin polished finish, heavy gauge



Art-Nr. Part No.		∅ innen ∅ Inside cm	Höhe Height cm
4650/125	0,3 l	11,5	5



Beilageschüssel, tief

aus Edelstahl, hochglänzend, mittelschwere Qualität

Vegetable Dish

stainless steel, mirror polished finish



Servierpfanne

aus Edelstahl 18/10, hochglänzend.
nicht zum Braten geeignet

Serving Pan

18/10 stainless steel, mirror polished finish,
not for cooking, only serving



18/10
EDELSTAHL
STAINLESS STEEL

Art-Nr. Part No.		∅ dia. cm	Höhe Height cm
6803/280	3 l	28	6,5
6803/300	5 l	30	7,5

Deckel 6899 bitte separat bestellen.
Please order lids separately (Part No. 6899)

Ovale Beilageschale

aus Edelstahl 18/10, hochglänzend

Oval Dish

18/10 stainless steel, mirror polished finish



18/10
EDELSTAHL
STAINLESS STEEL

Art-Nr. Part No.	Länge Length cm	Breite Width cm	Höhe Height cm
6806/180	0,5 l	18	3,5
6806/210	0,7 l	21	3,5
6806/260	1 l	26	3,5
6806/300	1,5 l	30	3,5

Deckel 6890 bitte separat bestellen.
Please order lids separately (Part No. 6890)

Ovale Gratinform

aus Edelstahl 18/10, hochglänzend, backofengeeignet

Oval gratin dish

18/10 stainless steel, mirror polished finish, ovenproof



18/10
EDELSTAHL
STAINLESS STEEL

BACKOFEN
OVEN

Art-Nr. Part No.	Länge innen Inner Length cm	Breite innen Inner Width cm	Höhe Height cm
6808/280	2 l	28	20

Deckel 6890 bitte separat bestellen.
Please order lids separately (Part No. 6890)

Knopfdeckel

passend zu Serien 6886, 6800, 6801, 6802, 6803, aus
Edelstahl 18/10, hochglänzend, ohne Löffelausschnitt

Lid

matches range 6886, 6800, 6801, 6802, 6803,
18/10 stainless steel, mirror polished finish,



18/10
EDELSTAHL
STAINLESS STEEL

Art-Nr. Part No.	passend zu Matches
6899/070	/070
6899/100	/100
6899/120	/120
6899/140	/140
6899/160	/160
6899/180	/180
6899/220	/220
6899/240	/240
6899/260	/260
6899/280	/280

Knopfdeckel, oval

zur Serie 6806, 6808, aus Edelstahl 18/10,
hochglänzend

Oval Lid

matches range 6806, 6808, 18/10 stainless steel,
mirror polished finish



18/10
EDELSTAHL
STAINLESS STEEL

Art-Nr. Part No.	passend zu Matches
6890/180	/180
6890/210	/210
6890/260	/260
6890/280	/280
6890/320	/300

Saucieren

Sauce/Gravy Boats



Art-Nr. Part No.	Höhe gesamt Overall Height cm	Länge Length cm
609/005	3	0,05 l 14
609/010	3	0,1 l 15,5
609/020	5	0,2 l 19
609/030	5,5	0,3 l 21
609/050	6,5	0,5 l 24



Sauciere ohne Fuß

aus Edelstahl 18/10, stapelbar, schwere Qualität

Gravy/Sauce Boat

18/10 stainless steel, stackable, heavy gauge



Art-Nr. Part No.	Höhe gesamt Overall Height cm	Länge Length cm
601/006	3,5	0,06 l 17
601/010	5	0,1 l 19
601/015	5,5	0,15 l 21
601/025	6	0,25 l 23



Sauciere ohne Fuß

aus Edelstahl 18/10, hochglänzend

Gravy/Sauce Boat

18/10 stainless steel, mirror polished finish



Art-Nr. Part No.	Höhe gesamt Overall Height cm	Länge Length cm
6882/010	5	0,1 l 19
6882/030	6	0,3 l 21



Sauciere ohne Fuß

aus Edelstahl 18/10, hochglänzend, schwere Qualität

Sauce Boat

18/10 stainless steel, mirror polished finish, heavy gauge



Art-Nr. Part No.	Höhe gesamt Overall Height cm	Länge Length cm
600/006	7,5	0,1 l 15
600/010	9	0,15 l 17
600/020	10	0,25 l 22
600/030	10	0,3 l 22,5
600/050	11,5	0,45 l 24



Sauciere mit Fuß

aus Edelstahl, hochglänzend

Gravy/Sauce Boat

with foot, stainless steel



Art-Nr. Part No.	Höhe gesamt Overall Height cm	Länge Length cm
603/008	7,5	0,08 l 14
603/015	9	0,15 l 16
603/025	10	0,2 l 19
603/040	11	0,45 l 22



Sauciere mit Fuß

aus Edelstahl 18/10, hochglänzend, schwere Qualität

Gravy/Sauce Boat

with foot, 18/10 stainless steel, mirror polished finish, heavy gauge



Art-Nr. Part No.	Länge Length cm	Breite Width cm	Höhe Height cm	
605/040	20	12,5	11,5	0,4 l



Thermosauciere

ganz aus Edelstahl 18/10, Sauciere und Klappdeckel doppelwandig, spülmaschinengeeignet

Gravy/Sauce Boat (insulated)

18/10 stainless steel, double walled body and lid, dishwasher safe



Abteilplatte, 3-teilig

aus Edelstahl 18/10, seidenmatt poliert, hergestellt auf Original-VDN®-Werkzeugen, schwere Qualität

Three Division Tray

18/10 stainless steel, satin polished finish, heavy gauge



Art-Nr. Part No.	Länge Length cm	Breite Width cm	Höhe Height cm	GN
Abteilplatte: / Three division tray:				
6627/003	32,5	27	3,5	1/2
Deckel zu 6627 Abteilplatte: / Lid for 6627 division tray:				
6627/290	30,5	25,5	2,3	1/2

Salatschale GN 1/6

aus Edelstahl 18/10

GN 1/6 Salad Dish

18/10 stainless steel



Art-Nr. Part No.	Breite Width cm	Länge Length cm	Höhe Height cm	GN
6616/040	16	17,6	4	0,7 I
6616/516	Deckel ohne Griffe / Lid without handle			

Abteilplatte, 5-teilig

aus Edelstahl 18/10, hochglänzend

Five Division Tray

18/10 stainless steel, mirror polished finish



Art-Nr. Part No.	Länge Length cm	Breite Width cm	Höhe Height cm
6610/005	41	28,5	2,5

Tellerwärmer

aus Edelstahl 18/10, hochglänzend, mit wärme-speicherndem Medium, Teller mit 14, 16 und 18 cm Bodendurchmesser sind durch die Innenrillen rutschsicher, schwere Qualität

Plate Warmer - insulated base

18/10 stainless steel, mirror polished finish, with built-in heat element, ridges in base are designed to keep plates with 14, 16 and 18 cm bases steady, heavy gauge



Art-Nr. Part No.	Höhe außen Outer Height cm	Ø Boden Ø Base cm	Ø max. cm
5219/248	3,5	19	25,6

Auf diesen Tellerwärmer passt die Tellerlocke 6480/264 (stapelbar) von Seite 400.

Matches plate cover 6480/264 (stackable) on page 400.

Warmhalteset

aus Edelstahl 18/10, hochglänzend, mit wärme-speicherndem Medium, passend für Teller bis 26 cm, Deckel doppelwandig, schwere Qualität

Plate Warmer - insulated base & lid

18/10 stainless steel, with built-in heat element, in base suitable for plates up to 26 cm Ø, heavy gauge



Art-Nr. Part No.	Höhe außen Outer Height cm	Ø Boden Ø Base cm	Ø max. cm
Doppelwandiges Unterteil mit Heizkern: / Base:			
5217/270	5,2	20	26,7

Doppelwandigen Deckel bitte separat bestellen: / Lid:

5218/270	4,7	27,9
----------	-----	------

Auf das Unterteil passt auch ein einwandiger Deckel: / Single walled plate cover also fits on top of base:

6480/278	4,5
----------	-----

Sonderanfertigungen auf Anfrage möglich.

Other sizes made to order on request.

Warmhalteset

aus weißem Polypropylen, ohne Griffloch, stapelbar, temperaturresistent von -20°C bis +120°C, recycelbar, spülmaschinenfest, mikrowellengeeignet

Plate Cover and Base Set

white polypropylene, without grip hole, stackable, temperature resistant -20°C to +120°C, dishwasher proof, unbreakable, suitable for microwave ovens, recyclable



Art-Nr. Part No.	Höhe gesamt Overall Height cm	Ø außen Ø Outside cm	Farbe Colour	Ø Teller Ø Plate cm
Set aus Unterteil und Deckel: / Set of base and lid:				
3218/001	10	28,5	weiß/white	26

Transportgestell (von Seite 498): / Plate carrier:

2516/029	30	30	grau/grey
----------	----	----	-----------

Für das Oberteil sind weitere Farben auf Anfrage erhältlich.

Further colours available for the upper part on request.

Warmhaltesets und Abteilplatten

Plate Warmers



contacto

Art-Nr. Part No.	∅ innen ∅ Inside cm	Höhe Height cm
6222/140	0,25 l	14



Muschelschale

aus weißer feuerfester Keramik, Boden unglasiert, backofengeeignet, vielfältige Einsatzmöglichkeit auch als Dessert- und Servierschälchen

Shell Dish

white oven proof ceramic, base unglazed, multi purpose



Art-Nr. Part No.	∅ dia. cm	Höhe Height cm
4671/110	0,2 l	11



Universalschale Blütenform

aus Edelstahl 18/10, hochglänzend, ideal als Dessert-, Eis- oder Fingerschale, schwere Qualität

Sundae Dish/Finger Bowl

18/10 stainless steel, mirror polished finish, heavy gauge



Art-Nr. Part No.	∅ innen ∅ Inside cm	Höhe gesamt Overall Height cm	Breite Width cm
---------------------	---------------------------	-------------------------------------	-----------------------

Mit zwei Schalen: / 2 dish set:			
1236/002	9,5	14	22

Mit drei Schalen: / 3 dish set:			
1236/003	9,5	14	20

Mit vier Schalen: / 4 dish set:			
1236/004	9,5	14	22

Einzelschale / Spare loose dish			
1236/100	9,5	4	0,2 l



Dip-Schalenset

aus Edelstahl 18/10, hochglänzend, mit herausnehmbaren Schalen, mit gebördeltem Rand

Snack Dish Set

18/10 stainless steel, mirror polished finish, fixed stem base and frame for loose dishes, with rolled edges



Art-Nr. Part No.	∅ dia. cm	Höhe Height cm
6224/032	0,3 l	13
6224/040	0,4 l	13



Snackschale

aus Edelstahl 18/10, hochglänzend

Snack Dish

18/10 stainless steel, mirror polished finish



Art-Nr. Part No.	∅ dia. cm	Höhe Height cm
6226/125	0,35 l	12,5



Snackschale

aus Edelstahl 18/10, hochglänzend, elegant gewölbte Form

Sundae/ Nut Dish

18/10 stainless steel, mirror polished finish, elegant shape



Art-Nr. Part No.	∅ innen ∅ Inside cm	Höhe Height cm
4626/130	0,25 l	13



Marmeladenschale

aus Edelstahl 18/10, hochglänzend, mit seitlichem Griff, schwere Qualität

Jam Dish

18/10 stainless steel, mirror polished finish, with one handle, heavy gauge





Besteck Luna

Die Besteckserie LUNA ist ein formschöner, zeitloser Klassiker aus hochwertigem Material für den alltäglichen sowie festlichen Einsatz bestimmt.

Luna Cutlery

The high quality extensive LUNA cutlery range is an elegant, timeless classic for both everyday and special use.

27-teilige Besteckserie aus Edelstahl 18/10, hochglänzend, Messer aus Edelstahl 18/0, hochqualitative Ausführung, Materialstärke: 2,5 mm

27-piece cutlery series in 18/10 stainless steel, high-gloss, knife in 18/0 stainless steel, high-quality finish, material thickness: 2.5 mm

18/0
EDELSTAHL
STAINLESS STEEL

18/0
EDELSTAHL
STAINLESS STEEL

Alle Preise sind Einzelpreise pro Stück, Abgabe nur in angegebenen VPE
Priced each, supplied in carton quantity



Menüöffel
Table Spoon

Art-Nr.	Länge	VPE
Part No.	Length	carton qty
1777/001	19,5 cm	12



Menügabel
Table Fork

Art-Nr.	Länge	VPE
Part No.	Length	carton qty
1777/002	19,5 cm	12



Menümesser (Vollheft)
Table Knife (solid handle)

Art-Nr.	Länge	VPE
Part No.	Length	carton qty
1777/003	23 cm	12



Dessertlöffel
Dessert Spoon

Art-Nr.	Länge	VPE
Part No.	Length	carton qty
1777/004	17 cm	12



Dessertgabel
Dessert Fork

Art-Nr.	Länge	VPE
Part No.	Length	carton qty
1777/005	17 cm	12



Dessertmesser
Dessert Knife

Art-Nr.	Länge	VPE
Part No.	Length	carton qty
1777/006	21 cm	12



Kaffeelöffel
Tea Spoon

Art-Nr.	Länge	VPE
Part No.	Length	carton qty
1777/007	13 cm	12



Mokkalöffel
Coffee Spoon

Art-Nr.	Länge	VPE
Part No.	Length	carton qty
1777/009	12 cm	12



Gourmetlöffel
Gourmet Spoon

Art-Nr.	Länge	VPE
Part No.	Length	carton qty
1777/011	17,5 cm	1



Suppenschöpfer
Soup Ladle

Art-Nr.	Länge	VPE
Part No.	Length	carton qty
1777/012	29 cm	1



Servierlöffel
Serving Spoon

Art-Nr.	Länge	VPE
Part No.	Length	carton qty
1777/016	23,5 cm	1



Serviergabel
Serving Fork

Art-Nr.	Länge	VPE
Part No.	Length	carton qty
1777/017	23,5 cm	1



Saucenlöffel
Sauce Ladle

Art-Nr.	Länge	VPE
Part No.	Length	carton qty
1777/018	17,5 cm	1



Salatlöffel
Salad Spoon

Art-Nr.	Länge	VPE
Part No.	Length	carton qty
1777/022	20 cm	1



Salatgabel
Salad Fork

Art-Nr.	Länge	VPE
Part No.	Length	carton qty
1777/023	20 cm	1



Fischserviergabel
Fish Serving Fork

Art-Nr.	Länge	VPE
Part No.	Length	carton qty
1777/032	24 cm	1



Fischserviermesser
Fish Serving knife (aus/in 18/10)

Art-Nr.	Länge	VPE
Part No.	Length	carton qty
1777/033	24 cm	1



Fischgabel
Fish Fork

Art-Nr.	Länge	VPE
Part No.	Length	carton qty
1777/035	19,5 cm	12



Fischmesser
Fish Knife (aus/in 18/10)

Art-Nr.	Länge	VPE
Part No.	Length	carton qty
1777/036	20 cm	12



Käsemesser
Cheese Knife

Art-Nr.	Länge	VPE
Part No.	Length	carton qty
1777/040	23,5 cm	12



Eislöffel
Ice Cream Spoon

Art-Nr.	Länge	VPE
Part No.	Length	carton qty
1777/052	13 cm	12



Zucker-/Käselöffel
Sugar/Cheese Spoon

Art-Nr.	Länge	VPE
Part No.	Length	carton qty
1777/055	13 cm	1



Tortenheber
Cake Server

Art-Nr.	Länge	VPE
Part No.	Length	carton qty
1777/059	22 cm	1



Kuchengabel
Cake Fork

Art-Nr.	Länge	VPE
Part No.	Length	carton qty
1777/064	15,5 cm	12



Buttermesser
Butter Knife

Art-Nr.	Länge	VPE
Part No.	Length	carton qty
1777/066	17 cm	12



Limonadenlöffel
Sundae Spoon

Art-Nr.	Länge	VPE
Part No.	Length	carton qty
1777/072	19,5 cm	12



Tassenlöffel
Soup Spoon

Art-Nr.	Länge	VPE
Part No.	Length	carton qty
1777/089	17 cm	12

PRODUKTION
EINGESTELLT
PRODUCTION
DISCONTINUED



Besteck *Louisa*

Das zeitlose Essbesteck LOUISA gibt es in einer breiten Auswahl zu einem guten Preis-Leistungsverhältnis. So ist es eine optische sowie praktische Bereicherung für jeden Gastronomen.

Louisa Cutlery

The attractive LOUISA cutlery range is good value and a practical choice.

21-teilige Besteckserie aus Edelstahl 18/10, hochglänzend, Messer aus Edelstahl 18/0, hochqualitative Ausführung, Materialstärke: 2,3 mm

21-piece cutlery series in 18/10 stainless steel, high-gloss, knife in 18/0 stainless steel, high-quality finish, material thickness: 2.3 mm



Alle Preise sind Einzelpreise pro Stück, Abgabe nur in angegebenen VPE
Priced each, supplied in carton quantity



Menülföfel
Table Spoon

Art-Nr.	Länge	VPE
Part No.	Length	carton qty
1999/001	19 cm	12



Menügabel
Table Fork

Art-Nr.	Länge	VPE
Part No.	Length	carton qty
1999/002	19 cm	12



Menümesser (Vollheft)
Table Knife (solid handle)

Art-Nr.	Länge	VPE
Part No.	Length	carton qty
1999/003	21 cm	12



Dessertlföfel
Dessert Spoon

Art-Nr.	Länge	VPE
Part No.	Length	carton qty
1999/004	17 cm	12



Dessertgabel
Dessert Fork

Art-Nr.	Länge	VPE
Part No.	Length	carton qty
1999/005	18 cm	12



Dessertmesser
Dessert Knife

Art-Nr.	Länge	VPE
Part No.	Length	carton qty
1999/006	20 cm	12



Kaffeelöfel
Tea Spoon

Art-Nr.	Länge	VPE
Part No.	Length	carton qty
1999/007	13,5 cm	12



Mokkalöfel
Coffee Spoon

Art-Nr.	Länge	VPE
Part No.	Length	carton qty
1999/009	11 cm	12



Suppenshöpfer
Soup Ladle

Art-Nr.	Länge	VPE
Part No.	Length	carton qty
1999/012	29,5 cm	1



Saucenlöfel
Sauce Ladle

Art-Nr.	Länge	VPE
Part No.	Length	carton qty
1999/018	17 cm	1



Salatlöfel
Salad Spoon

Art-Nr.	Länge	VPE
Part No.	Length	carton qty
1999/022	19,5 cm	1



Salatgabel
Salad Fork

Art-Nr.	Länge	VPE
Part No.	Length	carton qty
1999/023	19,5 cm	1



Aufschnittgabel
Serving Fork

Art-Nr.	Länge	VPE
Part No.	Length	carton qty
1999/030	16 cm	12



Fischmesser
Fish Knife

Art-Nr.	Länge	VPE
Part No.	Length	carton qty
1999/036	19,5 cm	12



Eislöffel
Ice Cream Spoon

Art-Nr.	Länge	VPE
Part No.	Length	carton qty
1999/052	13 cm	12



Tortenheber
Cake Server

Art-Nr.	Länge	VPE
Part No.	Length	carton qty
1999/059	23 cm	1



Kuchengabel
Cake Fork

Art-Nr.	Länge	VPE
Part No.	Length	carton qty
1999/064	15 cm	12



Limonadenlöffel
Sundae Spoon

Art-Nr.	Länge	VPE
Part No.	Length	carton qty
1999/072	22 cm	12



Zuckerzange
Sugar Tongs

Art-Nr.	Länge	VPE
Part No.	Length	carton qty
1999/077	11 cm	1



Steakmesser
Steak Knife

Art-Nr.	Länge	VPE
Part No.	Length	carton qty
1999/078	22 cm	12



Eierlöffel
Egg Spoon

Art-Nr.	Länge	VPE
Part No.	Length	carton qty
1999/088	13 cm	12



Besteck **Santorini**

Schlicht und gleichzeitig elegant! Das ist die Besteckserie SANTORINI von **contacto**. Das Essbesteck, made in Europe, ist zu besonderen Anlässen als auch im Alltag die richtige Wahl.

Santorini Cutlery

Simple and elegant at the same time! The SANTORINI cutlery range from **contacto**, made in Europe, is the right choice for special occasions as well as everyday life.

10-teilige Besteckserie aus Edelstahl 18/10, hochglänzend, Messerklinge aus Edelstahl 18/0, hochqualitative Ausführung, Materialstärke: 2,5 mm

10-piece cutlery series in 18/10 stainless steel, high-gloss, knife blade in 18/0 stainless steel, high-quality finish, material thickness: 2.5 mm

18/10
EDELSTAHL
STAINLESS STEEL

18/0
EDELSTAHL
STAINLESS STEEL

Alle Preise sind Einzelpreise pro Stück, Abgabe nur in angegebenen VPE
Priced each, supplied in carton quantity



Menüöffel
Table Spoon

Art-Nr.	Länge	VPE
Part No.	Length	carton qty
1333/001	19,5 cm	12



Menügabel
Table Fork

Art-Nr.	Länge	VPE
Part No.	Length	carton qty
1333/002	19,5 cm	12



Menümesser (Vollheft)
Table Knife (solid handle)

Art-Nr.	Länge	VPE
Part No.	Length	carton qty
1333/003	23 cm	12



Dessertlöffel
Dessert Spoon

Art-Nr.	Länge	VPE
Part No.	Length	carton qty
1333/004	17 cm	12



Dessertgabel
Dessert Fork

Art-Nr.	Länge	VPE
Part No.	Length	carton qty
1333/005	17 cm	12



Dessertmesser
Dessert Knife

Art-Nr.	Länge	VPE
Part No.	Length	carton qty
1333/006	21,5 cm	12



Kaffeelöffel
Tea Spoon

Art-Nr.	Länge	VPE
Part No.	Length	carton qty
1333/007	13 cm	12



Mokkalöffel
Coffee Spoon

Art-Nr.	Länge	VPE
Part No.	Length	carton qty
1333/009	11 cm	12



Kuchengabel
Cake Fork

Art-Nr.	Länge	VPE
Part No.	Length	carton qty
1333/064	15,5 cm	12



Tassenlöffel
Soup Spoon

Art-Nr.	Länge	VPE
Part No.	Length	carton qty
1333/089	16,5 cm	12



Besteck **me! FIRST**

Die Kinderbesteckserie ist perfekt für die kleinen Hände und deren Motorik. Sicheres Besteck um selbständiges Essen zu trainieren.

me! FIRST Cutlery

This children's cutlery range is perfect for small hands.

4-teilige Kinderbesteckserie aus Edelstahl 18/10, hochglänzend, Messerklinge aus Edelstahl 18/0, hochqualitative Ausführung, Materialstärke: 2,5 mm

4-piece cutlery series in 18/10 stainless steel, high-gloss, knife blade in 18/0 stainless steel, high quality finish, material thickness: 2.5 mm

18/10
EDELSTAHL
STAINLESS STEEL

18/0
EDELSTAHL
STAINLESS STEEL

Alle Preise sind Einzelpreise pro Stück, Abgabe nur in angegebenen VPE
Priced each, supplied in carton quantity



Menülföfel (Vollheft)
Table Spoon

Art-Nr.	Länge	VPE
Part No.	Length	carton qty
3233/001	15 cm	12



Menügabel
Table Fork

Art-Nr.	Länge	VPE
Part No.	Length	carton qty
3233/002	16,5 cm	12



Menümesser (Vollheft)
Table Knife (solid handle)

Art-Nr.	Länge	VPE
Part No.	Length	carton qty
3233/003	18 cm	12



Dessertlöffel
Dessert Spoon

Art-Nr.	Länge	VPE
Part No.	Length	carton qty
3233/007	12 cm	12



Besteck *Atlantic*

Neutrales Design trifft funktionale Topqualität für den universellen Einsatzbereich.
ATLANTIC ist die preisgünstige Wahl mit Topqualität.

Atlantic Cutlery

Clean design suitable for all occasions.

7-teilige Besteckserie aus Edelstahl 18/0,
hochglänzend, Materialstärke: 2,7 mm

7-piece cutlery series in 18/0 stainless steel,
high-gloss, material thickness: 2.7 mm

18/0
EDELSTAHL
STAINLESS STEEL

Alle Preise sind Einzelpreise pro Stück,
Abgabe nur in angegebenen VPE
Priced each, supplied in carton quantity



Menüöffel
Table Spoon

Art-Nr.	Länge	VPE
Part No.	Length	carton qty
1188/001	19 cm	6



Menügabel
Table Fork

Art-Nr.	Länge	VPE
Part No.	Length	carton qty
1188/002	19 cm	6



Menümesser (Vollheft)
Table Knife (solid handle)

Art-Nr.	Länge	VPE
Part No.	Length	carton qty
1188/003	20 cm	3



Kaffeelöffel
Tea Spoon

Art-Nr.	Länge	VPE
Part No.	Length	carton qty
1188/007	14 cm	6



Mokkalöffel
Coffee Spoon

Art-Nr.	Länge	VPE
Part No.	Length	carton qty
1188/009	11 cm	6



Kuchengabel
Cake Fork

Art-Nr.	Länge	VPE
Part No.	Length	carton qty
1188/064	14 cm	6



Limonadenlöffel
Sundae Spoon

Art-Nr.	Länge	VPE
Part No.	Length	carton qty
1188/072	19,5 cm	6



Besteck Campus

Das preiswerte Kantinenbesteck CAMPUS besticht mit seinem hübschen Dekor und angenehmer Haptik.

Campus Cutlery

CAMPUS cutlery with its simple decoration and pleasant feel is a good economic choice.

7-teilige Besteckserie aus Edelstahl 18/0, hochglänzend, Materialstärke: 1,9mm

7-piece cutlery series in 18/0 stainless steel, mirror polished finishing, material thickness: 1.9mm



Alle Preise sind Einzelpreise pro Stück, Abgabe nur in angegebenen VPE
Priced each, supplied in carton quantity



Menüöffel
Table Spoon

Art-Nr.	Länge	VPE
Part No.	Length	carton qty
1122/001	19 cm	6



Menügabel
Table Fork

Art-Nr.	Länge	VPE
Part No.	Length	carton qty
1122/002	19 cm	6



Menümesser (Vollheft)
Table Knife (solid handle)

Art-Nr.	Länge	VPE
Part No.	Length	carton qty
1122/003	22 cm	3



Kaffeelöffel
Tea Spoon

Art-Nr.	Länge	VPE
Part No.	Length	carton qty
1122/007	13,5 cm	6



Mokkalöffel
Coffee Spoon

Art-Nr.	Länge	VPE
Part No.	Length	carton qty
1122/009	11,5 cm	6



Kuchengabel
Cake Fork

Art-Nr.	Länge	VPE
Part No.	Length	carton qty
1122/064	16,5 cm	6



Limonadenlöffel
Sundae Spoon

Art-Nr.	Länge	VPE
Part No.	Length	carton qty
1122/072	19 cm	6



Besteck **Isabella**

Das Besteck ISABELLA ist solide verarbeitet, hat eine sehr gute Materialstärke, ist preisgünstig und somit ideal für den Kantinenbereich geeignet.

Isabella *Cutlery*

ISABELLA cutlery is well made and good value.

14-teilige Besteckserie aus Edelstahl 18/0, hochglänzend, Materialstärke: 2,7 mm

14-piece cutlery series in 18/0 stainless steel, mirror polished finishing, material thickness: 2.7 mm

18/0
EDELSTAHL
STAINLESS STEEL

Alle Preise sind Einzelpreise pro Stück, Abgabe nur in angegebenen VPE
Priced each, supplied in carton quantity



Menüöffel
Table Spoon

Art-Nr.	Länge	VPE
Part No.	Length	carton qty
404/001	18,5 cm	12



Menügabel
Table Fork

Art-Nr.	Länge	VPE
Part No.	Length	carton qty
404/002	18,5 cm	12



Menümesser (Vollheft)
Table Knife (solid handle)

Art-Nr.	Länge	VPE
Part No.	Length	carton qty
404/003	20 cm	12



Dessertlöffel
Dessert Spoon

Art-Nr.	Länge	VPE
Part No.	Length	carton qty
404/004	16 cm	12



Dessertgabel
Dessert Fork

Art-Nr.	Länge	VPE
Part No.	Length	carton qty
404/005	16 cm	12



Dessertmesser
Dessert Knife

Art-Nr.	Länge	VPE
Part No.	Length	carton qty
404/006	17 cm	12



Kaffeelöffel
Coffee Spoon

Art-Nr.	Länge	VPE
Part No.	Length	carton qty
404/007	13 cm	12



Mokkalöffel
Coffee Spoon

Art-Nr.	Länge	VPE
Part No.	Length	carton qty
404/009	11 cm	12



Servierlöffel
Serving Spoon

Art-Nr.	Länge	VPE
Part No.	Length	carton qty
404/016	21,5 cm	1



Saucenlöffel
Sauce Ladle

Art-Nr.	Länge	VPE
Part No.	Length	carton qty
404/018	19 cm	1



Aufschnittgabel
Serving Fork

Art-Nr.	Länge	VPE
Part No.	Length	carton qty
404/030	18 cm	12



Tortenheber
Cake Server

Art-Nr.	Länge	VPE
Part No.	Length	carton qty
404/059	25 cm	1



Kuchengabel
Cake Fork

Art-Nr.	Länge	VPE
Part No.	Length	carton qty
404/064	14 cm	12



Limonadenlöffel
Sundae Spoon

Art-Nr.	Länge	VPE
Part No.	Length	carton qty
404/072	19 cm	12



Besteck event

Die Serie EVENT aus rostfreien Edelstahl, mit dem dezenten Dekor und Funktionalität ist besonders im Cateringbereich beliebt.

event Cutlery

EVENT cutlery: the name says it all.

7-teilige Besteckserie aus Edelstahl 18/10, hochglänzend, Messerklinge aus Edelstahl 18/0, hochqualitative Ausführung, Materialstärke: 2,0mm

7-piece cutlery series in 18/10 stainless steel, high-gloss, knife blade in 18/0 stainless steel, high-quality finish, material thickness: 2.0mm

18/10
EDELSTAHL
STAINLESS STEEL

18/0
EDELSTAHL
STAINLESS STEEL

Alle Preise sind Einzelpreise pro Stück, Abgabe nur in angegebenen VPE
Priced each, supplied in carton quantity



Menüöffel
Table Spoon

Art-Nr.	Länge	VPE
Part No.	Length	carton qty
1133/001	19 cm	6



Menügabel
Table Fork

Art-Nr.	Länge	VPE
Part No.	Length	carton qty
1133/002	19 cm	6



Menümesser (Vollheft)
Table Knife (solid handle)

Art-Nr.	Länge	VPE
Part No.	Length	carton qty
1133/003	22 cm	3



Kaffeelöffel
Tea Spoon

Art-Nr.	Länge	VPE
Part No.	Length	carton qty
1133/007	13 cm	6



Mokkalöffel
Coffee Spoon

Art-Nr.	Länge	VPE
Part No.	Length	carton qty
1133/009	11 cm	6



Kuchengabel
Cake Fork

Art-Nr.	Länge	VPE
Part No.	Length	carton qty
1133/064	14 cm	6



Limonadenlöffel
Sundae Spoon

Art-Nr.	Länge	VPE
Part No.	Length	carton qty
1133/072	19 cm	6



Besteck Sophie

Das hochglänzende Besteck SOPHIE ist aufgrund seiner Optik und dem hervorragenden Preis-Leistungs-Verhältnis ideal fürs Catering.

Sophie Cutlery

SOPHIE cutlery is ideal for mass catering due to its shiny appearance and value for money.

5-teilige Besteckserie aus Edelstahl 18/0, hochglänzend, Materialstärke: 2,0mm

5-piece cutlery series in 18/0 stainless steel, mirror polished finishing, material thickness: 2.0mm



Alle Preise sind Einzelpreise pro Stück, Abgabe nur in angegebenen VPE
Priced each, supplied in carton quantity



Menüöffel
Table Spoon

Art-Nr.	Länge	VPE
Part No.	Length	carton qty
1111/001	19 cm	12



Menügabel
Table Fork

Art-Nr.	Länge	VPE
Part No.	Length	carton qty
1111/002	19 cm	12



Menümesser (Vollheft)
Table Knife (solid handle)

Art-Nr.	Länge	VPE
Part No.	Length	carton qty
1111/003	21,5 cm	12



Kaffeelöffel
Coffee Spoon

Art-Nr.	Länge	VPE
Part No.	Length	carton qty
1111/007	13,5 cm	12



Kuchengabel
Cake Fork

Art-Nr.	Länge	VPE
Part No.	Length	carton qty
1111/064	14 cm	12



Steak- & Spezialbesteck

Schneiden Sie an. Die Steakbestecke aus Edelstahl für Grillfleisch oder Pizzas sind aus solider Qualität, spülmaschinengeeignet und im zeitlosen Design.

Steak & Assorted Cutlery

Steak cutlery and anything from a tiny salt spoon to an olive fork.

Steakbesteck LUNA

Gabel aus Edelstahl 18/10, hochglänzend, schwere Qualität

Steak Cutlery Set

18/10 stainless steel fork, mirror polished finish, heavy gauge



Art-Nr.	Länge	
Part No.	Length	
4444/002	19,5 cm	Gabel/Fork
4444/003	22,5 cm	Messer/Knife

Preis je Stück. Besteck wird nur dutzendweise abgegeben.
Priced each. Only available in dozens.

Steakbesteck

Besteckserie LOUISA, Tafelgabel aus Edelstahl 18/10

Steak Cutlery

18/10 stainless steel table fork



Art-Nr.	Länge	
Part No.	Length	
1999/002	19 cm	Gabel/Fork
1999/078	22 cm	Messer/Knife

Preis je Stück. Besteck wird nur dutzendweise abgegeben.
Priced each. Only available in dozens.

Steakbesteck

aus Edelstahl 18/0, mit schwarzen POM-Griffen, spülmaschinengeeignet

Steak Cutlery Set

18/0 stainless steel, mirror polished finish, with POM handles, dishwasher safe



Art-Nr.	Länge
Part No.	Length

Set mit je 6 Messern (22 cm) und 6 Gabeln (20 cm) im weißen Karton:
/ Set of 6 knives (8 3/4") and 6 forks (8"), plain boxed:

3333/012	22 cm / 20 cm
----------	---------------

3333/003	Einzelnes Steakmesser / Single steak knives
----------	---

Steakbesteck, groß

Messer mit gezahnter Klinge, mit extra großem Griff aus Holzimitat, spülmaschinengeeignet

Large Steak Cutlery

serrated knife, large wood imitation handle, dishwasher safe



Art-Nr.	Klingenlänge	Länge gesamt	
Part No.	Blade Length	Total Length	
	cm	cm	
4660/245	12,5	24,5	Messer/Knife
4660/002		21	Gabel/Fork

Art-Nr. Part No.	Klingenlänge Blade cm	Klingenlänge Blade Zoll	Länge gesamt Total Length cm
4608/115	11,5	4½"	21,5



Steak-/Küchenmesser

geschmiedete Klinge aus Messerstahl, mit Wellenschliff, vernieteter und verschweißter Griff aus schwarzem Melamin, spülmaschinengeeignet

Steak/Vegetable Knife

tempered stainless steel, serrated, black melamine handle, dishwasher safe



Art-Nr. Part No.	Klingenlänge Blade Length cm	Klingenlänge Blade Length Zoll	Länge gesamt Total Length cm
4666/230	12	4½"	23



Steakmesser

aus Edelstahl 18/0, mit Wellenschliff, mit schwarzem Griff aus POM, spülmaschinengeeignet

Steak Knife

18/0 stainless steel, serrated, black POM handle, dishwasher safe



Art-Nr. Part No.	Klingenlänge Blade Length cm	Klingenlänge Blade Length Zoll	Länge Length cm
5577/003	11 cm	4¼"	22



Steak-/Pizzamesser

aus Edelstahl 18/0, mit Griff aus schwarzem ABS-Kunststoff, mit feingezahnter Klinge

Steak Knife

18/0 stainless steel, with black ABS handle, finely serrated edge



Art-Nr. Part No.	Klingenlänge Blade cm	Klingenlänge Blade Zoll	Länge gesamt Total Length cm
7784/245	12	5"	24,5



Steak-/ Tomatenmesser

Serie ERGONOM, aus Edelstahl 18/0, Griff aus Edelstahl 18/10, fugenlos, mit gezahnter Klinge

Steak / Tomato Knife

18/10 stainless steel handle, ergonomically designed, 18/0 stainless steel blade with serrated edge



Art-Nr. Part No.	Klingenlänge Blade Length cm	Klingenlänge Blade Length Zoll	Länge Length cm
5555/003	12 cm	4¾"	23



Steakmesser

aus Edelstahl 18/0, mit Griff in Pistolenform aus Edelstahl 18/10, fugenlos, mit gezahnter Klinge bis zur Spitze

Steak Knife

18/0 stainless steel blade, 18/10 stainless steel handle, serrated edge



Art-Nr. Part No.	Klingenlänge Blade Length cm	Klingenlänge Blade Length Zoll	Länge Length cm
1190/003	10	4"	21

Preis je Stück. Dieses Besteckteil wird nur dutzendweise angegeben.
Priced each. Only available in dozens.



Pizzamesser

ganz aus Edelstahl 18/0, mit gezahnter Klinge

Pizza Knife

18/0 stainless steel, serrated blade



Buttermesser

Besteckserie LUNA, aus Edelstahl 18/0, hochglänzend

Butter Knife

18/0 stainless steel, mirror polished finish



Art-Nr.	Länge
Part No.	Length
1777/066	17 cm

Aufstrichmesser

aus flexiblem Edelstahl 18/0, hochglänzend, mit Griff aus schwarzem Polypropylen, mit glatter Klinge, zum gleichmäßigen Aufstreichen von Butter, Streichwurst oder -käse usw.

Sandwich Knife

18/0 stainless steel, mirror polished finish, flexible blade, black polypropylene handle



Art-Nr.	Spatelmaß Blade	Länge gesamt Total Length
Part No.	cm	cm
4077/230	11,5 x 3,5	21

Butterroller

aus gezahntem Edelstahl 18/0, mit schwarzem glasfaserverstärkten Polyamid-Griff, spülmaschinengeeignet, zur Herstellung von Butterlocken

Butter Curler

18/0 stainless steel, serrated edge, black fibreglass reinforced polyamide handle, dishwasher safe



Art-Nr.	Länge
Part No.	Length
2238/190	19 cm

Eierlöffel

aus Edelstahl 18/10, hochglänzend

Egg Spoon

18/10 stainless steel, mirror polished finish



Art-Nr.	Länge
Part No.	Length
8005/125	12,5 cm
Preis je Stück. Besteck wird nur dutzendweise abgegeben. Priced each. Only available in dozens.	

Eierlöffel

Besteckserie LOUISA, aus Edelstahl 18/10, hochglänzend

Egg Spoon

18/10 stainless steel, mirror polished finish



Art-Nr.	Länge
Part No.	Length
1999/088	13,5 cm

Eierlöffel

aus weißem Polystyrol

Egg Spoon

white polystyrene plastic



Art-Nr.	Länge
Part No.	Length
4910/125	12,5 cm

Salzlöffel

aus klarem SAN, stark angewinkelte Laffe

Salt Spoon

clear SAN plastic



Art-Nr.	Länge
Part No.	Length
4905/065	6,5 cm

Art-Nr. Part No.	Länge Length
8055/085	8,5 cm



Senflöffel

aus Edelstahl 18/0, hochglänzend

Mustard Spoon

18/0 stainless steel, mirror polished finish



Art-Nr. Part No.	Länge Length cm
666/100	10



Senflöffel

ovale Laffe, aus klarem SAN

Mustard Spoon

oval bowl, clear SAN



Art-Nr. Part No.	Länge Length cm	Löffelmaß Bowl Size cm
geschlossen: / plain: 1272/170	17	4,5 x 2,5
perforiert: / perforated: 1272/171	17	4,5 x 2,5



Olivenlöffel

aus Edelstahl 18/10, zum Entnehmen einzelner Oliven
auch aus tiefen Gläsern am Buffet

Olive Spoon

18/10 stainless steel, for removing single olives e.g.
from deep jars at the buffet



Art-Nr. Part No.	Löffelmaß Size	Länge gesamt Total Length
1999/099	6 cm x 4 cm	12 cm



Party-/Buffetlöffel

Edelstahl 18/10, hochglänzend, zum Präsentieren von
Löffelcanapés und Häppchen bei Partys und Steh-
empfangen

Canapé / Cocktail Spoon

18/10 stainless steel, mirror polished finish heavy
gauge, for presenting spoon canapés and snacks



Art-Nr. Part No.	Höhe Height cm	Breite Width cm	Zinkenlänge Prongs Length cm
8003/002	6,5	3	1,3



Partygabel

aus Edelstahl 18/0, hochglänzend poliert

Canapé Fork

18/0 stainless steel, mirror polished finish



Art-Nr. Part No.	Länge Length cm	Zinkenlänge Prongs Length cm	Ø Griff Ø Handle cm
1271/095	9,5	2	1,2

Preis einzeln. Empfohlene Verpackungseinheit 6 Stück.
Priced each. Recommended packing unit 6 pcs.



Olivengabel

aus Edelstahl 18/10

Olive Fork

18/10 stainless steel



Art-Nr. Part No.	Länge Length
2085/250	25 cm



Olivenlöffel

aus Edelstahl 18/10, hochglänzend polierte Laffe,
matt polierter Griff

Olive Spoon

18/10 stainless steel, mirror polished finish spoon,
matt polished tubular handle



Menagen & Mühlen

Scharfe Sache. Lassen Sie Ihren Gast mit Menagen und Mühlen nachwürzen. Bei der großen Auswahl ist für jeden Tisch und jedes Ambiente das richtige Set dabei.

Condiments & Mills

A huge selection of condiment sets and mills is complemented by butter dishes and egg cups.

Menage Essig/Öl

aus verchromtem Draht, mit leeren Flaschen für Essig und Öl aus klarem und grünem Glas, mit innenliegendem Ausgießer aus Kunststoff, Schraubverschluss aus Metall

Oil & Vinegar Condiment Set

chrome plated wire holder, empty clear and green glass oil & vinegar bottles, plastic pourer, with screw fitting metal cap



Art-Nr. Part No.	ml	Länge Length cm	Breite Width cm	Höhe Height cm
2727/100	100	9,5	5	18,5
2727/250	250	11	6	25,5

5863/030 Ersatzausgießer + Schraubverschluss / Spare pourer and cap

Weitere Ersatzteile (Gestelle, Flaschen) auf Anfrage. Die Flaschen können auch ohne Etikett für Ihre individuelle Aufmachung geliefert werden. Further spare parts (holder, bottles) available on request. Bottles can be ordered without labels for your own customization.

Menage Essig/Öl, Sauce

aus verchromtem Draht, mit leeren Flaschen für Essig, Öl und Sauce, davon zwei aus klarem und eine aus grünem Glas, mit innenliegendem Ausgießer aus Kunststoff, Schraubverschluss aus Metall

Oil & Vinegar Condiment Set

chrome plated wire holder, two empty clear and one green glass oil & vinegar & sauce bottles, plastic pourer, with screw fitting metal cap



Art-Nr. Part No.	ml	Länge Length cm	Breite Width cm	Höhe Height cm
2728/103	100	14,5	5	18,5
2728/253	250	17,5	6	25,5

5863/030 Ersatzausgießer + Schraubverschluss / Spare pourer and cap

Weitere Ersatzteile (Gestelle, Flaschen) auf Anfrage. Die Flaschen können auch ohne Etikett für Ihre individuelle Aufmachung geliefert werden. Further spare parts (holder, bottles) available on request. Bottles can be ordered without labels for your own customization.

Menage Salz/Pfeffer, Essig/Öl

aus verchromtem Draht, mit leeren Flaschen für Essig und Öl aus klarem und grünem Glas, mit innenliegendem Ausgießer aus Kunststoff, Schraubverschluss aus Metall, Salz- und Pfefferstreuer

Condiment Set

chrome plated wire holder, empty clear and green glass oil & vinegar bottles, plastic pourer, with screw fitting metal cap, salt and pepper pots



Art-Nr. Part No.	ml	Länge Length cm	Breite Width cm	Höhe Height cm
2729/004	100	9,5	9	18,5

666/901 Ersatz-Salzstreuer / Spare salt pot

666/902 Ersatz-Pfefferstreuer / Spare pepper pot

5863/030 Ersatzausgießer + Schraubverschluss / Spare pourer and cap

Weitere Ersatzteile (Gestelle, Flaschen) auf Anfrage. Die Flaschen können auch ohne Etikett für Ihre individuelle Aufmachung geliefert werden. Further spare parts (holder, bottles) available on request. Bottles can be ordered without labels for your own customization.

Art-Nr. Part No.	Länge Length cm	Breite Width cm	Höhe Height cm
888/001	11	6	14
888/901	Ersatzstreuer Salz / Spare pepper pot & top		
888/902	Ersatzstreuer Pfeffer / Spare salt pot & top		



Menage Salz/Pfeffer

Gestell aus hochglänzendem Edelstahl 18/10, mit schweren, glatten Glaseinsätzen für Salz und Pfeffer

Salt & Pepper Condiment Set

18/10 stainless steel holder, heavy glass salt & pepper pots, mirror polished finish



Art-Nr. Part No.	Länge Length cm	Breite Width cm	Höhe Height cm
888/002	15	9	21,5
888/904	Ersatzzeinsatz Öl / Spare oil bottle & top		
888/905	Ersatzzeinsatz Essig / Spare vinegar bottle & top		



Menage Essig/Öl

Gestell aus hochglänzendem Edelstahl 18/10, mit schweren, glatten Glaseinsätzen für Essig und Öl

Oil & Vinegar Condiment Set

18/10 stainless steel holder, mirror polished finish, heavy glass oil & vinegar bottles



Art-Nr. Part No.	Länge Length cm	Breite Width cm	Höhe Height cm
888/003	10,5	10,5	14
888/901	Ersatzstreuer Salz / Spare pepper pot & top		
888/902	Ersatzstreuer Pfeffer / Spare salt pot & top		
888/903	Ersatzbehälter Zahnstocher / Spare toothpick pot		



Menage Salz/Pfeffer, Zahnstocher

Gestell und Zahnstocherbehälter aus hochglänzendem Edelstahl 18/10, mit schweren, glatten Glaseinsätzen für Salz, Pfeffer und Zahnstocher

Salt & Pepper Condiment Set

18/10 stainless steel holder and toothpick pot, mirror polished finish, heavy glass salt & pepper pots



Art-Nr. Part No.	Länge Length cm	Breite Width cm	Höhe Height cm
888/004	15	12	21,5
888/901	Ersatzstreuer Salz / Spare pepper pot & top		
888/902	Ersatzstreuer Pfeffer / Spare salt pot & top		
888/904	Ersatzzeinsatz Öl / Spare oil bottle & top		
888/905	Ersatzzeinsatz Essig / Spare vinegar bottle & top		



Menage Salz/Pfeffer, Essig/Öl

Gestell aus hochglänzendem Edelstahl 18/10, mit schweren, glatten Glaseinsätzen für Salz, Pfeffer, Essig und Öl

Condiment Set

18/10 stainless steel holder, mirror polished finish, heavy glass oil & vinegar, salt & pepper pots



Art-Nr. Part No.	Länge Length cm	Breite Width cm	Höhe Height cm
888/005	15	12	21,5
888/901	Ersatzstreuer Salz / Spare pepper pot & top		
888/902	Ersatzstreuer Pfeffer / Spare salt pot & top		
888/903	Ersatzbehälter Zahnstocher / Spare toothpick pot		
888/904	Ersatzzeinsatz Öl / Spare oil bottle & top		
888/905	Ersatzzeinsatz Essig / Spare vinegar bottle & top		



Menage Salz/Pfeffer, Essig/Öl, Zahnstocher

Gestell und Zahnstocherbehälter aus hochglänzendem Edelstahl 18/10, mit schweren, glatten Glaseinsätzen für Salz, Pfeffer, Essig, Öl

Condiment Set

18/10 stainless steel holder and toothpick pot, mirror polished finish, heavy glass oil & vinegar and salt & pepper pots



Art-Nr. Part No.	∅ dia. cm	Höhe Height cm
889/001	0,2 l	6
990/901	Ersatzglas / Spare glass pot	



Parmesandose

aus Edelstahl 18/10, hochglänzend, mit schwerem Glaseinsatz, Deckel mit Löffelausschnitt, auch für Konfitüren geeignet

Parmesan Pot

18/10 stainless steel, mirror polished finish, with heavy glass pot, lid notched for spoon



**Menage Salz/Pfeffer, Essig/Öl,
Zahnstocher**

aus Edelstahl 18/0, hochglänzend, mit glatten
Glaseinsätzen für Salz und Pfeffer, Essig und Öl (mit
tropffreien Ausgüssen) sowie Zahnstocher

Condiment Set

18/0 stainless steel holder, mirror polished, glass oil &
vinegar bottles (non drip), toothpick, salt & pepper pots



Art-Nr. Part No.	Länge Length cm	Breite Width cm	Höhe Height cm
700/005	14	11	19
1411/902	Ersatzstreuer Salz/Pfeffer à 12 Stück / Spare salt & pepper pot (dozen)		
1412/904	Ersatzzeinsatz Öl / Essig / Spare Oil & Vinegar bottle		
700/903	Ersatzglas Zahnstocher / Spare toothpick pot		

Menage Salz/Pfeffer

aus Edelstahl 18/0, hochglänzend,
mit geriffelten Glaseinsätzen

Salt & Pepper Condiment Set

18/0 stainless steel holder, mirror polished finish,
glass salt & pepper pots



Art-Nr. Part No.	Länge Length cm	Breite Width cm	Höhe Height cm
444/002	10	5,3	11,5
666/901	Ersatzstreuer Salz (ähnlich) / Spare salt pot (different top)		
666/902	Ersatzstreuer Pfeffer (ähnlich) / Spare pepper pot (different top)		

Menage Essig/Öl

aus Edelstahl 18/0, hochglänzend,
mit schweren geriffelten Glaseinsätzen für Essig und Öl

Oil & Vinegar Condiment Set

18/10 stainless steel holder, mirror polished finish,
heavy glass oil & vinegar bottles



Art-Nr. Part No.	Länge Length cm	Breite Width cm	Höhe Height cm
444/012	12	6	16
444/904	Ersatzflasche / Spare bottle		

Menage Salz/Pfeffer, Essig/Öl

aus Edelstahl 18/10, hochglänzend,
mit schweren geriffelten Glaseinsätzen für Salz und
Pfeffer, sowie Essig und Öl (mit tropffreien Ausgüssen)

Condiment Set

18/10 stainless steel holder, mirror polished finish,
heavy glass oil & vinegar bottles (non drip),
salt & pepper pots



Art-Nr. Part No.	Länge Length cm	Breite Width cm	Höhe Height cm
444/004	14	11	15
444/904	Ersatzzeinsatz Öl/Essig / Spare oil & vinegar bottle		
666/901	Ersatzstreuer Salz (ähnlich) / Spare salt pot (different top)		
666/902	Ersatzstreuer Pfeffer (ähnlich) / Spare pepper pot (different top)		

**Menage Salz/Pfeffer, Essig/Öl,
Zahnstocher**

aus Edelstahl 18/10, hochglänzend, mit schweren
geriffelten Glaseinsätzen für Salz und Pfeffer, Essig und
Öl (mit tropffreien Ausgüssen) sowie Zahnstocher

Condiment Set

18/10 stainless steel holder, mirror polished finish,
heavy glass oil & vinegar bottles (non drip), toothpick,
salt & pepper pots



Art-Nr. Part No.	Länge Length cm	Breite Width cm	Höhe Height cm
444/005	14	11	15
666/901	Ersatzstreuer Salz (ähnlich) / Spare salt pot & top (different top)		
666/902	Ersatzstreuer Pfeffer (ähnlich) / Spare pepper pot & top (different top)		
444/904	Ersatzflasche Öl / Essig / Spare Oil & Vinegar bottle		
129/901	Ersatzzeinsatz Zahnstocher / Spare toothpick pot		

Art-Nr. Part No.	Länge Length cm	Breite Width cm	Höhe Height cm
1411/002	8	3,5	12
1411/902	Ersatzstreuer à 12 Stück / Salt/Pepper Pot (3 holes) per dozen.		



Menage Salz/Pfeffer

Gestell aus hochglänzendem Edelstahl 18/0, mit schwarzem Kunststoffboden, Pressglaseinsätze mit Kappen aus Edelstahl 18/10

Salt & Pepper Condiment Set

18/0 stainless steel holder, with black plastic bottom, glass salt & pepper pots with 18/10 stainless steel tops



Art-Nr. Part No.	Länge Length cm	Breite Width cm	Höhe Height cm
1412/002	11	5	22
1412/904	Ersatzflasche Öl/Essig zu / Spare bottle Oil/Vinegar		



Menage Essig/Öl

Gestell aus hochglänzendem Edelstahl 18/0, mit schwarzem Kunststoffboden, Pressglaseinsätze mit Kappen aus Edelstahl 18/10, tropfsicherer Ausgießer mit Rücklauftrichter

Oil & Vinegar Condiment Set

18/0 stainless steel holder, with black plastic bottom, glass oil & vinegar bottles with 18/10 stainless steel tops



Art-Nr. Part No.	Länge Length cm	Breite Width cm	Höhe Height cm
1413/003	8	10	12,5
1411/902	Ersatzstreuer à 12 Stück / Salt/Pepper Pot (3 holes) per dozen		
1413/903	Ersatz-Senfglas mit Deckel und Löffel: / Spare mustard pot with lid and spoon:		



Menage Salz/Pfeffer, Senf, Halter

Gestell aus hochglänzendem Edelstahl 18/0, mit schwarzem Kunststoffboden, Pressglaseinsätze mit Kappen aus Edelstahl 18/10, Senfglas mit Löffel, Halter für Speisekarten oder Servietten

Condiment Set

18/0 stainless steel holder with black plastic bottom, glass mustard, salt & pepper pots with 18/10 stainless steel tops, menu and napkin holder



Art-Nr. Part No.	Länge Length cm	Breite Width cm	Höhe Height cm
1414/004	9,5	9,5	22
1411/902	Ersatzstreuer à 12 Stück / Salt/Pepper Pot (3 holes) per dozen		
1412/904	Ersatzflasche Öl/Essig / Spare bottle Oil/Vinegar		



Menage Salz/Pfeffer, Essig/Öl

Gestell aus hochglänzendem Edelstahl 18/0, mit schwarzem Kunststoffboden, Pressglaseinsätze mit Kappen aus Edelstahl 18/10, tropfsicherer Ausgießer mit Rücklauftrichter

Condiment Set

18/0 stainless steel holder, with black plastic bottom, glass oil & vinegar bottles and salt & pepper pots with 18/10 stainless steel tops



Art-Nr. Part No.	Länge Length cm	Breite Width cm	Höhe Height cm
1416/002	8	5,5	12
1411/902	Ersatzstreuer à 12 Stück / Salt/Pepper Pot (3 holes) per dozen		



Menage Salz/Pfeffer, Servietten

Gestell aus hochglänzendem Edelstahl 18/0, mit schwarzem Kunststoffboden, Pressglaseinsätze mit Kappen aus Edelstahl 18/10, Halter für Speisekarten oder Servietten

Salt/Pepper Condiment Set

18/0 stainless steel holder, with black plastic bottom, glass salt & pepper pots with 18/10 stainless steel tops



Art-Nr. Part No.	∅ dia. cm	Höhe Height cm
1417/001	0,2 l 9,5	6

Keine Ersatzgläser lieferbar.
No spare parts available.



Parmesandose

Gestell aus hochglänzendem Edelstahl 18/0, mit schwarzem Kunststoffboden, Deckel aus Edelstahl 18/10, mit Löffel, auch für Konfitüren geeignet

Parmesan Pot

18/0 stainless steel holder, with black plastic bottom, glass pot with 18/10 stainless steel lid, with spoon



Menage Salz/Pfeffer

aus Edelstahl 18/0, hochglänzend,
mit Pressglaseinsätzen

Salt & Pepper Condiment Set

18/0 stainless steel holder, mirror polished finish,
glass salt & pepper pots



Art-Nr. Part No.	Länge Length cm	Breite Width cm	Höhe Height cm
122/002	10,5	5,5	10,5
127/185	Salzstreuer à 12 Stück / Salt/Pepper Pot (15 hole) per dozen:		
127/186	Pfefferstreuer à 12 Stück / Salt/Pepper Pot (5 hole) per dozen:		

Menage Salz/Pfeffer, Zahnstocher

aus Edelstahl 18/0, hochglänzend,
mit Pressglaseinsätzen für Salz und Pfeffer,
Kunststoffeinsatz für Zahnstocher

Condiment Set

18/0 stainless steel holder, mirror polished finish,
plastic toothpick, glass salt & pepper pots



Art-Nr. Part No.	Länge Length cm	Breite Width cm	Höhe Height cm
129/003	12	8	12,5
129/901	Ersatzzeinsatz Zahnstocher / Spare part toothpick pot		
127/185	Salzstreuer à 12 Stück: / Salt/Pepper Pot (15 hole) per dozen:		
127/186	Pfefferstreuer à 12 Stück: / Pepper/Salt Pot (5 hole) per dozen:		

Menage Salz/Pfeffer, Senf

aus Edelstahl 18/0, hochglänzend,
mit Pressglaseinsätzen

Condiment Set

18/0 stainless steel holder, mirror polished finish,
glass mustard, salt & pepper pots



Art-Nr. Part No.	∅ dia. cm	Höhe Height cm
123/003	13	14,5
123/901	Ersatzzeinsatz Senf mit Löffel / Spare mustard pot, top & spoon	
127/185	Salzstreuer à 12 Stück: / Salt/Pepper Pot (15 hole) per dozen:	
127/186	Pfefferstreuer à 12 Stück: / Pepper/Salt Pot (5 hole) per dozen:	

Menage Salz/Pfeffer, Maggi®

aus Edelstahl 18/0, hochglänzend,
mit Salz- und Pfefferstreuer,
für handelsübliche 125g-Flaschen für Maggi® u.ä.

Condiment Set

18/0 stainless steel holder, mirror polished finish, glass
salt & pepper pots, (excludes 125 g bottle for Maggi®)



Art-Nr. Part No.	∅ dia. cm	Höhe Height cm
121/003	13,5	14
127/185	Salzstreuer à 12 Stück: / Salt/Pepper Pot (15 hole) per dozen:	
127/186	Pfefferstreuer à 12 Stück: / Pepper/Salt Pot (5 hole) per dozen:	

Lieferung mit Salz- und Pfefferstreuer, aber ohne die abgebildete Maggiflasche.

Supplied with salt and pepper pots, but without the Maggi bottle shown.

Menage Salz/Pfeffer, Essig/Öl, Senf

aus Edelstahl 18/0, hochglänzend,
mit Pressglaseinsätzen

Condiment Set

18/0 stainless steel holder, mirror polished finish,
glass mustard, oil & vinegar, salt & pepper pots



Art-Nr. Part No.	∅ dia. cm	Höhe Height cm
126/005	15,5	16,5
123/901	Ersatzzeinsatz Senf mit Deckel, Löffel / Spare mustard pot, top & spoon	
126/901	Ersatzflasche Öl/Essig mit Stöpsel / Spare oil/vinegar bottle with cap	
127/185	Salzstreuer à 12 Stück: / Salt/Pepper Pot (15 hole) per dozen:	
127/186	Pfefferstreuer à 12 Stück: / Pepper/Salt Pot (5 hole) per dozen:	

Art-Nr. Part No.	Länge Length cm	Breite Width cm	Höhe Height cm
666/002	10	6,5	15
666/901	Ersatzstreuer Salz / Spare salt pot & top		
666/902	Ersatzstreuer Pfeffer / Spare pepper pot & top		



Menage Salz/Pfeffer

aus Edelstahl 18/0, hochglänzend,
mit Riffelglaseinsätzen

Salt & Pepper Condiment Set

18/0 stainless steel holder, mirror polished finish,
glass salt & pepper pots



Art-Nr. Part No.	∅ dia. cm	Höhe Height cm
3251/005	13	16,5
666/901	Ersatzstreuer Salz / Spare salt pot & top	
666/902	Ersatzstreuer Pfeffer / Spare pepper pot & top	
444/904	Ersatzeinsatz Öl/Essig / Spare oil & vinegar bottle	
666/903	Ersatzeinsatz Senf / Spare mustard pot, top & spoon	



Menage Salz/Pfeffer, Essig/Öl, Senf

aus Edelstahl 18/10, hochglänzend,
mit schweren geriffelten Glaseinsätzen für Salz und
Pfeffer, Essig und Öl (mit tropffreien Ausgüssen)
sowie Senf, mit Klemmvorrichtung für Speisekarten

Condiment Set

18/10 stainless steel tray with menu holder,
mirror polished finish, heavy glass oil & vinegar bottles
(non drip), mustard, salt & pepper pots



Art-Nr. Part No.	∅ dia. cm	Höhe Height cm
3250/130	13	16,5



Menagengestell

aus Edelstahl 18/10, für frei kombinierbare Menagen,
mit Klemmvorrichtung für Speisekarten

Condiment Tray

18/10 stainless steel, for any cruet sets,
with menu holder



Art-Nr. Part No.	Länge Length cm	Breite Width cm	Höhe Height cm
2741/004	17	13	16
6788/120	Ersatz-Mühlenset / Spare Mill Set		



Menage in Holzkiste

Kiste aus Fichtenholz, bestückt mit Pfeffer- und
Salzmühle aus Acryl, Öl- und Essigflasche

Cruet Set in Wooden Box

wooden case, equipped with acrylic pepper and salt
mill, oil and vinegar bottle



Art-Nr. Part No.	∅ dia. cm	Höhe Height cm
108/105	0,2 l	5,5
990/901	Ersatzglas / Spare glass pot	



Parmesandose

aus Edelstahl 18/10, hochglänzend,
mit schwerem glattem Glaseinsatz, Scharnier-Deckel
mit Löffelausschnitt, auch für Konfitüren geeignet

Parmesan Pot

18/10 stainless steel, mirror polished finish,
with heavy glass pot, lid notched for spoon



Salz-/Pfefferstreuer Leuchtturm

aus klarem Pressglas, mit verchromten Messingkappen

Lighthouse Salt & Pepper Pots

glass, with chrome plated brass tops



Art-Nr. Part No.		∅ dia. cm	Höhe Height cm
128/121	0,025 l	4,5	12
128/122	0,025 l	4,5	12

Verpackung/Preis à 12 St.
Priced & packed in dozens.

Salz-/Pfefferstreuer

aus geriffeltem Pressglas, Kappe aus Edelstahl 18/0

Salt & Pepper Pots

glass with 18/0 stainless steel top



Art-Nr. Part No.	∅ Glas max. ∅ Glass max.	Höhe Height
---------------------	-----------------------------	----------------

Salzstreuer à 12 Stück: / Pepper/Salt Pot (15 hole) per dozen:
127/185 4 cm 8 cm

Pfefferstreuer à 12 Stück: / Salt/Pepper Pot (5 hole) per dozen:
127/186 4 cm 8 cm

Verpackung/Preis à 12 St.
Priced & packed in dozens.

Salz-/Pfefferstreuer

aus geriffeltem Pressglas, mit Kappe aus Edelstahl 18/0

Salt & Pepper Pots

glass, with stainless steel 18/10 top



Art-Nr. Part No.	∅ Glas max. ∅ Glass max.	Höhe Height
---------------------	-----------------------------	----------------

Salzstreuer: / Salt Pot
666/901 3,8 cm 7 cm

Pfefferstreuer: / Pepper Pot
666/902 3,8 cm 7 cm

Salz-/Pfefferstreuer

aus glattem Pressglas, Edelstahlkappe mit Kunststoffdichtung, extra hochwertige Qualität

Salt & Pepper Pots

glass, with stainless steel top, with plastic seal



Art-Nr. Part No.	∅ Glas max. ∅ Glass max.	Höhe Height
---------------------	-----------------------------	----------------

Salzstreuer: / Pepper Pot:
888/901 3,5 cm 8 cm

Pfefferstreuer: / Salt Pot:
888/902 3,5 cm 8 cm

Salz-/Pfefferstreuer

aus glattem Pressglas, Kappe aus Edelstahl

Salt & Pepper Pots

glass, with stainless steel top



Art-Nr. Part No.	∅ Glas max. ∅ Glass max. cm	Höhe Height cm
1411/902	3	9

Preis und Verpackung à 12 Stück.
Priced and packed in dozens.

Salz-/Pfefferstreuer

aus glattem Pressglas, quadratische Form, mit Kappe aus Edelstahl, matt poliert

Salt & Pepper Pots

square glass, with stainless steel top, satin polished



Art-Nr. Part No.	Breite Width cm	Höhe Height cm
134/105	4	10,5

Preis und Verpackung à 12 Stück.
Priced and packed in dozens.

Art-Nr.	∅ Boden	Höhe
Part No.	∅ Base	Height
119/002	6,5 cm	8,5 cm

Salz: mit einem Loch ∅ 2 mm,
Pfeffer: mit vier Löchern ∅ 1,5 mm

Salt: with one hole ∅ 2 mm,
Pepper: with four holes ∅ 1.5 mm



Salz-/Pfefferstreuer Set

aus Edelstahl 18/10, hochglänzend,
mit Kunststoff-Stöpsel in der Bodenfläche

Set of Salt & Pepper Pots

18/10 stainless steel, mirror polished finish,
with plastic stopper in the base



Art-Nr.	∅ Glas max.	Höhe
Part No.	∅ Glass max.	Height
125/001	3,5 cm	4 cm



Mini-Streuer, rund

für Salz oder Pfeffer, aus glattem Pressglas,
Kappe aus Edelstahl 18/0

Mini Salt & Pepper Pot

glass with 18/0 stainless steel top, for room service



Art-Nr.	∅ max.	Höhe
Part No.	∅ max.	Height
127/040	3 cm	4,5 cm



Mini-Streuer

für Salz oder Pfeffer, aus geriffeltem Pressglas,
mit Kappe aus Edelstahl 18/0

Mini Salt/Pepper Pot

glass with 18/0 stainless steel top, for room service



Art-Nr.	Größe	Höhe
Part No.	Size	Height
	cm	cm

Salz & Pfeffer-Menage: / Cruet Set Salt & Pepper:
1429/222 7,5 x 3,5 7 0,012 l

Pfefferstreuer mit einem Loch: / Salt Pot with one big hole:
1429/001 3 x 3 5,5 0,012 l

Salzstreuer mit 6 Löchern: / Pepper Pot with 6 holes:
1429/002 3 x 3 5,5 0,012 l



Mini-Streuer 'Würfel'

aus glattem Pressglas, mit verchromten Messingkappen,
Rahmen aus hochglanzverchromtem Stahl

Mini Salt & Pepper Pots

glass with chrome plated brass tops, holder chrome
plated steel, mirror polished finish, for room service



Art-Nr.	Länge
Part No.	Length
8055/085	8,5 cm



Senflöffel

aus Edelstahl 18/0, hochglänzend

Mustard Spoon

18/0 stainless steel, mirror polished finish



Art-Nr.	Länge
Part No.	Length
666/100	10 cm



Senflöffel

ovale Laffe, aus klarem SAN

Mustard Spoon

oval bowl, clear SAN



Art-Nr.	Länge
Part No.	Length
4910/125	12,5 cm



Eierlöffel

aus weißem Polystyrol

Egg Spoon

white polystyrene plastic



Salz-/Pfeffermühlen-Set

aus Acrylglas, Salzmühle mit robustem Kunststoff-Mahlwerk, Pfeffermühle mit hochwertigem Keramik-Mahlwerk

Acrylic Salt & Peppermill Set

clear acrylic, strong plastic mechanism for salt, high quality ceramic mechanism for pepper



Art-Nr. Part No.		Ø dia. cm	Höhe Height cm
6795/100	0,07 l	5	10

Salz-/Pfeffermühlen-Set

aus Acrylglas, Salzmühle mit robustem Kunststoff-Mahlwerk, Pfeffermühle mit hochwertigem Keramik-Mahlwerk

Acrylic Salt & Peppermill Set

strong plastic mechanism for salt, high quality ceramic mechanism for pepper



Art-Nr. Part No.		Ø dia. cm	Höhe Height cm
6788/120	0,05 l	5,5	12,5

für ca. 30g Pfeffer- und 55g Salzkörner: / for approx. 30 g pepper and 55 g salt:

6788/120	0,05 l	5,5	12,5
----------	--------	-----	------

für ca. 55g Pfeffer- und 100g Salzkörner: / for approx. 55 g pepper and 100 g salt:

6788/175	0,08 l	6	17,5
----------	--------	---	------

Preis/Verpackung je Set .
Priced per box.

Salz-/Pfeffermühlen-Set

aus schwarzem Acryl, Salzmühle mit robustem Kunststoff-Mahlwerk, Pfeffermühle mit hochwertigem Keramik-Mahlwerk

Acrylic Salt & Peppermill Set

black acrylic, strong plastic mechanism for salt, high quality ceramic mechanism for pepper



Art-Nr. Part No.		Ø dia. cm	Höhe Height cm
6796/090	0,07 l	5	10

Salz- und Pfeffermühle

aus schwarzem Acrylglas, Salzmühle mit robustem Kunststoff-Mahlwerk, Pfeffermühle mit hochwertigem Keramik-Mahlwerk

Acrylic Salt & Peppermill

high quality ceramic mechanism for pepper, strong plastic mechanism for salt



Art-Nr. Part No.		Ø dia. cm	Höhe Height cm	
6863/181	0,15 l	6,5	16,5	Pfeffer/Pepper
6863/182	0,15 l	6,5	16,5	Salz/Salt

Pfeffermühle

aus Acrylglas, mit Keramik-Mahlwerk, das Mahlwerk befindet sich oben, so dass nach dem Absetzen der Mühle keine Pfefferreste auf dem Tisch verbleiben

Acrylic Peppermill

high quality ceramic mechanism, grinder is located at the top, so that the table is kept clean



Art-Nr. Part No.		Ø dia. cm	Höhe Height cm
6794/210	0,18	8,5	21

Salz- und Pfeffermühlen

Salt and Pepper Mills



Art-Nr. Part No.	∅ dia. cm	Höhe Height cm
für ca. 20 g Pfeffer- und 50 g Salzkörner / for approx. 20 g pepper and 50 g salt		
6867/160	0,03 l	5 16



Salzstreuer & Pfeffermühlen-Set
aus dunkel gebeiztem Gummibaumholz, Pfeffermühle mit hochwertigem Keramik-Mahlwerk

Saltshaker & Peppermill Set
dark rubberwood, high quality ceramic mechanism for pepper



Art-Nr. Part No.	∅ dia. cm	Höhe Height cm
Für ca. 35 g Pfefferkörner: / For approx. 35 g pepper:		
6868/220	0,05 l	6 22
Für ca. 55 g Pfefferkörner: / for approx. 55 g pepper:		
6868/320	0,08 l	6,7 32
Für ca. 75 g Pfefferkörner: / for approx. 75 g pepper:		
6868/440	0,1 l	7 44



Pfeffermühle
aus dunkel gebeiztem Gummibaumholz, mit hochwertigem Keramik-Mahlwerk

Peppermill
dark stained rubberwood, ceramic mechanism



Art-Nr. Part No.	∅ dia. cm	Höhe Height cm
Für ca. 20 g Pfefferkörner: / For approx. 20 g pepper:		
6869/160	0,02 l	5,5 16
Für ca. 35 g Pfefferkörner: / For approx. 35 g pepper:		
6869/210	0,05 l	6 21
Für ca. 75 g Pfefferkörner: / For approx. 75 g pepper:		
6869/315	0,1 l	6,5 32



Pfeffermühle
aus naturfarbenem Buchenholz, mit hochwertigem Keramik-Mahlwerk

Peppermill
natural coloured beech wood, high quality ceramic mechanism



Art-Nr. Part No.	Höhe Height cm	∅ dia. cm
6855/100	15	7



Parmesanmühle
aus klarem Polycarbonat und schwarzem ABS-Kunststoff, mit Edelstahlmahlwerk, der Parmesankeise wird in zwei Kammern eingefüllt, durch Drehen des Kopfes wird die Druckplatte angepresst und der Käse gemahlen, der Gast sieht den frischen Parmesan, alles bleibt hygienisch, zerlegbar, spülmaschinengeeignet

Parmesan Cheese Mill
clear polycarbonate with black ABS plastic, stainless steel mechanism, the cheese fills two chambers, by turning the top, the pressure plate presses the cheese against the grinder, the guest sees fresh parmesan, the operation stays hygienic, can be taken apart, dishwasher safe



Butterpfännchen

aus Edelstahl 18/10, hochglänzend,
mit Ausgusschnaupe und stabilem Drahtgriff (Ø 4 mm),
schwere Qualität

Butter Pan

18/10 stainless steel, mirror polished, with pouring lip,
solid 4 mm wire handle, heavy gauge



Art-Nr. Part No.	Ø dia. cm	Höhe Height cm	Stiellänge Handle Length cm	
544/120	12	5	11	0,4 l
544/140	14	6	12,5	0,7 l

Butter- / Fettlöffel

aus Edelstahl 18/10, hochglänzend, fugenlos

Butter/Fat Ladle

18/10 stainless steel, mirror polished finish



Art-Nr. Part No.	Stiellänge Handle Length cm	Ø dia. cm
543/090	9 cm	2,5 cm

Butterschale mit Cloche

aus schwerem Glas mit Cloche aus Edelstahl 18/10,
hochglänzend, hochwertige Qualität

Butter Dish with Cloche

heavy high quality glass with 18/10 stainless steel
cloche, mirror polished finish, heavy gauge



Art-Nr. Part No.	Ø außen Ø Outside cm	Höhe gesamt Overall Height cm	Ø innen Ø Inside cm	
6889/001	9	8	5,3	0,06 l

Glasschale auch lose erhältlich: / Spare glass dish

8889/890	9	4,5	5,3	0,06 l
----------	---	-----	-----	--------

Cloche einzeln: / Spare cloche:

6889/901	7	5,5
----------	---	-----

Butterschale mit Cloche

aus schwerem Glas, mit Cloche aus Edelstahl 18/10,
hochglänzend poliert, Knopf vergoldet

Butter Dish with Cloche

heavy high quality glass, with 18/10 stainless steel
cloche, mirror polished finish, with gold plated knob



Art-Nr. Part No.	Ø außen Ø Outside cm	Höhe gesamt Overall Height cm	Ø innen Ø Inside cm	
8889/001	9	8	5,3	0,06 l

Glasschale auch lose erhältlich: / Spare glass dish

8889/890	9	4,5	5,3	0,06 l
----------	---	-----	-----	--------

Cloche einzeln: / Spare cloche

8889/901	7	5,5
----------	---	-----

Butterdose

ganz aus Edelstahl 18/10, hochglänzend,
geeignet für 250 g Butter

Butter Dish

18/10 stainless steel, mirror polished finish,
for 250 g butter



Art-Nr. Part No.	Länge außen Outer Length cm	Breite außen Outer Width cm	Höhe gesamt Overall Height cm
3282/185	18,5	12,5	5,5

Buttermesser

Besteckserie LUNA, aus Edelstahl 18/0, hochglänzend

Butter Knife

18/0 stainless steel, mirror polished finish



Art-Nr. Part No.	Länge Length cm
1777/066	17 cm

Buttermesser

Besteckserie KATJA, aus Edelstahl 18/10, hochglänzend

Butter Knife

18/10 stainless steel, mirror polished finish



Art-Nr. Part No.	Länge Length cm
1666/066	17 cm

Eierbecher

Egg Cups



Art-Nr. Part No.	∅ dia.	Höhe Height
8020/032	5 cm	5,5 cm



Eierbecher mit Fuß

aus Edelstahl, außen hochglänzend

Egg Cup

stainless steel, outside mirror polished finish



Art-Nr. Part No.	∅ dia.	Höhe Height
8025/040	5 cm	4 cm



Eierbecher mit Loch

aus Edelstahl, außen hochglänzend

Egg Cup

with hole in base, stainless steel, outside mirror polished finish



Art-Nr. Part No.	∅ oben ∅ Top cm	Höhe Height cm
8028/040	4,5	4



Eierbecher

aus Edelstahl 18/10, mit Griffbügel, hochglänzend poliert, Miniaturform eines Eimers

Egg Cup

18/10 stainless steel, with handle, mirror polished finish, mini bucket shape



Art-Nr. Part No.	∅ dia.	Höhe Height
8000/085	8,5 cm	2 cm



Eierbecher, rund

aus Edelstahl, hochglänzend

Egg Cup/ Saucer

stainless steel, mirror polished finish



Art-Nr. Part No.	Größe Size cm
8030/100	10 x 10 x 2,5



Eierbecher, dreieckig

aus Edelstahl, hochglänzend

Egg Cup/Saucer

stainless steel, mirror polished finish



Art-Nr. Part No.	∅ dia.	Höhe Height
8008/080	8 cm	3 cm



Eierbecher

aus Edelstahl 18/10, hochglänzend, mit Griffmulden

Egg Cup

18/10 stainless steel, mirror polished finish



Honig, Zucker & Sahne

Versüßen Sie das Leben. Honig, der Zucker und die Sahne für den Kaffee oder Tee geben dem Frühstück seinen Glanz - am besten in hochglänzendem Edelstahl von **contacto**.

Honey, Sugar & Cream

Honey and jam pots, sugar bowls and cream jugs: ideal for breakfast or simply with tea or coffee.



Honigspender

aus Pressglas mit verchromter Kunststoffkappe, mit Abstellgefäß

Cream/Honey Pourer

glass, with chrome plated plastic top & handle, with glass dispenser stand



Art-Nr. Part No.	∅ max. cm	Höhe gesamt Overall Height cm
337/200	200 ml	8,5

Ersatzteile auf Anfrage erhältlich.
Spare parts available on request.



Honigtopf

mit Dosierstab und Deckel, aus Acryl in Bienenstockoptik, nicht spülmaschinengeeignet

Honey Pot

acrylic with serving dipper and lid, not suitable for dishwasher



Art-Nr. Part No.	∅ max. cm	Höhe gesamt Overall Height cm
328/200	0,2 l	9



Honigspirale

aus Edelstahl, zum Portionieren von Honig

Honey Dipper

stainless steel



Art-Nr. Part No.	Länge Length cm	∅ dia. cm
2188/150	15	3





Art-Nr. Part No.	∅ außen ∅ Outside cm	Höhe gesamt Overall Height cm	∅ Schale ∅ Bowl cm
3291/003	14	13	6
2709/060	Ersatzglasschale / Spare glass bowl		
Lieferung unmontiert supplied flat packed			



Marmeladenschalen-Etagere

aus Edelstahl 18/10, Tragegriff aus Edelstahl 18/10, mit drei handelsüblichen Glasschälchen

Jam Pot Tree

18/10 stainless steel holder and handle, with 3 glass bowls



Art-Nr. Part No.	∅ außen ∅ Outside cm	Höhe gesamt Overall Height cm
Für 3 Gläser auf einer Ebene: / For 3 pots:		
3287/003	10 cm	14 cm
Für 6 Gläser auf zwei Ebenen: / For 6 pots - 2 tier:		
3287/006	10 cm	14 cm
Passende Gläser bitte separat bestellen (à 8 Stück): / Matching glasses (packed and prices by 8th):		
2740/050	4,5 cm	5 cm



Marmeladenglas-Etagere

aus Edelstahl 18/10, hochglänzend, für drei bzw. sechs kleine Marmeladen-/Honig-Gläser bzw. Konfitürenschälchen mit max. ∅ 4,5 cm, in die Säule kann Dekoration eingesteckt werden

Jam Pot Tree

18/10 stainless steel, mirror polished finish, for three or six small jam pots of max. ∅ 4.5 cm diameter, suitable for fresh flowers



Art-Nr. Part No.	∅ außen ∅ Outside cm	Höhe Height cm	VPE carton qty
2740/050	4,5	5,3	50 ml 8
2740/901	Deckel, weiß / white lid		
2740/903	Deckel rot/weiß / red-white lid		
2740/909	Deckel goldfarben / gold coloured lid		
Preise je Verpackungseinheit. Priced per carton quantity.			



Marmeladenglas

aus glattem geblasenem Glas, mit dichtem weißem Schraubdeckel

Jam Pot

plain blown glass, with sealed white screw fitting lid



Art-Nr. Part No.	VPE carton qty	∅ dia. cm	Höhe Height cm
2705/120	12	6	5,5
2705/230	6	7,5	7
2705/350	6	7,5	10
2705/440	6	7,5	12
Preis je Verpackungseinheit. Ersatzdeckel auf Anfrage. Priced per carton quantity. Spare lids on request.			



Einkochglas

mit kunststoffversiegeltem Schraubdeckel aus Stahl, gemischt blau und rot kariert, die Deckel sind nicht spülmaschinengeeignet, zum Lagern von eingekochten Speisen

Jam Jar

with plastic sealed steel screw cap, mixed blue and red gingham, lids are not dishwasher safe



Zuckerkugel

aus Edelstahl 18/10, hochglänzend, Scharnierdeckel mit Kugelgriff, für 500 g Würfel- oder losen Zucker

Sugar Bowl

18/10 stainless steel, mirror polished, roll top lid with knob, holds 500 g sugar



Art-Nr. Part No.	∅ dia.	Höhe Height
2193/130	13 cm	14,5 cm

Zuckerdose

aus Edelstahl 18/10, hochglänzend, mit Löffelausschnitt im Einhandklappdeckel, schwere Qualität

Sugar Bowl

18/10 stainless steel, mirror polished finish, hinged lid notched for spoon, heavy gauge



Art-Nr. Part No.	∅ dia.	Höhe Height
116/035	0,35 l	8 cm

Zuckerdose oval

aus Edelstahl 18/10, hochglänzend, Scharnierdeckel mit zwei Löffelaussparungen, schwere Qualität

Oval Sugar Bowl

18/10 stainless steel, mirror polished finish, with hinged lid, notched for two spoons, heavy gauge



Art-Nr. Part No.	Länge Length	Breite Width	Höhe Height
2192/200	1 l	20,5 cm	13 cm

Zuckerdose

aus Edelstahl 18/10, hochglänzend, Knopfdeckel mit Löffelausschnitt

Jam Pot

18/10 stainless steel, mirror polished finish, lid notched for spoon with knob



Art-Nr. Part No.	∅ dia.	Höhe Height
2196/010	0,25 l	10 cm

Kandisdose

aus Edelstahl 18/10, hochglänzend, Knopfdeckel ohne Löffelausschnitt

Jam Pot/ Sugar Bowl

18/10 stainless steel, mirror polished finish, lid with knob



Art-Nr. Part No.	∅ dia.	Höhe Height
2195/010	0,25 l	10 cm

Zuckerteller

aus Edelstahl 18/10, hochglänzend poliert

Sugar Bowl

18/10 stainless steel, mirror polished finish



Art-Nr. Part No.	∅ dia.	Höhe Height
115/065	6,5 cm	2 cm
115/100	10 cm	3 cm

Zuckerteller

aus Edelstahl, hochglänzend

Sugar Bowl

stainless steel, mirror polished finish



Art-Nr. Part No.	∅ dia.	Höhe Height
4625/006	6,5 cm	1,5 cm

Art-Nr. Part No.	Länge Length
171/135	12 cm



Zuckerzange

aus Edelstahl 18/0, hochglänzend, fugenlos

Serrated Sugar Tongs

18/0 stainless steel, mirror polished finish, one piece



Art-Nr. Part No.	Länge Length
183/115	11,5 cm



Zuckerzange

Edelstahl, hochglänzend, fugenlos

Sugar Tongs

stainless steel, mirror polished finish, one piece



Art-Nr. Part No.	Länge Length
1455/105	10,5 cm



Zuckerzange

aus Edelstahl 18/0, fugenlos, Greifer mit Muscheldecor

Sugar Tongs

18/0 stainless steel, one piece



Art-Nr. Part No.	Länge Length
1999/077	10,5 cm



Zuckerzange

Besteckserie LOUISA, aus Edelstahl 18/10, hochglänzend, fugenlos

Sugar Tongs

18/10 stainless steel, mirror polished finish, one piece



Art-Nr. Part No.	Höhe Height
---------------------	----------------

PRODUKTION
EINGESTELLT
PRODUCTION
DISCONTINUED



Sahne-/ Honigspender

aus geriffeltem Pressglas, mit verchromter Kunststoffkappe, nur das Glas ist spülmaschinengeeignet

Cream/Honey Pourer

glass, with chrome plated plastic top & handle, only the glass is dishwasher safe



Art-Nr. Part No.	∅ dia.	Höhe Height
1447/200	200 ml	7,5 cm
1447/280	280 ml	8,5 cm



Zuckerstreuer

kugelförmig, aus glattem Pressglas, verchromte Kunststoffkappe, nur das Glas ist spülmaschinengeeignet

Sugar Pourer

glass with chrome plated top, only the glass is dishwasher safe



Zuckerstreuer

aus glattem Pressglas, verchromte Kunststoffkappe,
nur das Glas ist spülmaschinengeeignet

Sugar Pourer

glass with chrome plated top,
only the glass is dishwasher safe



Art-Nr. Part No.	Größe Size cm	Höhe Height cm
1446/200	200 ml	6 x 6 13

Zuckerstreuer

aus geriffeltem Pressglas, mit Kappe aus Edelstahl 18/0
und langem Dosierrohr, spülmaschinengeeignet

Sugar Pourer

glass with 18/0 stainless steel screw top,
dishwasher safe



Art-Nr. Part No.	Höhe Height
matt: / satin:	
330/100	150 ml 9,5 cm
hochglänzend: / mirror polished:	
330/200	250 ml 11,5 cm
331/100	Ersatzglas /100 / Spare glass
331/200	Ersatzglas /200 / Spare glass

Zuckerstreuer

aus glattem Pressglas, mit Kappe aus Edelstahl
eingefasst in griffigem ABS-Kunststoff,
mit langem Dosierrohr, spülmaschinengeeignet

Sugar Pourer

glass, with stainless steel screw top covered with black
ABS plastic, dishwasher safe



Art-Nr. Part No.	Höhe Height cm	Ø dia. cm
335/100	125 ml 16	7

Zuckerstreuer

aus geriffeltem Pressglas, mit Kappe aus Edelstahl 18/0,
mit langem Dosierrohr, spülmaschinengeeignet,
für ca. 300 g Zucker

Sugar Pourer

glass, with 18/0 stainless steel screw top,
dishwasher safe, holds about 300 g sugar



Art-Nr. Part No.	Ø dia. cm	Höhe gesamt Overall Height cm
334/300	300 ml 8	18
334/901	Ersatzglas / Spare glass	

Zuckerstreuer

aus klarem Glas, mit Schraubkappe aus Edelstahl 18/0,
Dosierung durch Klappe, spülmaschinengeeignet

Sugar Shaker

clear glass, with 18/0 stainless steel screw top,
with side flap, dishwasher proof



Art-Nr. Part No.	Ø max. cm	Höhe Height cm
1422/301	300 ml 7,5	14

Zuckerstreuer

aus glattem Pressglas, mit Kappe aus Edelstahl 18/0,
spülmaschinengeeignet

Sugar Pourer

glass, 18/0 stainless steel screw top,
mirror polished finish, dishwasher safe



Art-Nr. Part No.	Ø dia. cm	Höhe Height cm
1428/225	225 ml 8,5	12
1428/901	Ersatzglas / Spare glass	



Art-Nr. Part No.	Länge Length cm	Breite Width cm
708/023	0,23 l	23 15,5

3-teilig: Zuckerdose, Sahnegießer und Tablett
3 piece: sugar bowl with lid, creamer and tray

Art-Nr. Part No.	Höhe gesamt Overall Height cm
705/015	0,15 l 6 cm
705/023	0,23 l 8 cm

Art-Nr. Part No.	Höhe gesamt Overall Height cm
703/015	0,15 l 4,5 cm



Zucker-Sahne-Set

Serie PRACTILUX, aus Edelstahl 18/10, hochglänzend, schwere Qualität

Sugar & Creamer Set

18/10 stainless steel, mirror polished finish, high quality



Sahnegießer

Serie PRACTILUX, aus Edelstahl 18/10, hochglänzend, mit Bodenring und Flachgriff, schwere Qualität

Creamer

18/10 stainless steel, mirror polished finish, high quality, with plain handle & foot



Zuckerdose

Serie PRACTILUX, aus Edelstahl 18/10, hochglänzend, mit Deckel und Bodenring, hochwertige Qualität

Sugar Bowl

18/10 stainless steel, mirror polished finish, with lid and foot, high quality



Art-Nr. Part No.	Länge Length cm	Breite Width cm
114/015	0,15 l	20 12

3-teilig: Zuckerdose, Sahnegießer und Tablett
3 piece: sugar bowl, creamer and tray



Zucker-Sahne-Set

aus Edelstahl 18/10, hochglänzend, schwere Qualität

Sugar & Creamer Set

18/10 stainless steel, mirror polished finish, heavy gauge



Art-Nr. Part No.	∅ dia. cm	Höhe Height cm
118/025	0,23 l 7,5	5



Sahnegießer

aus Edelstahl 18/10, hochglänzend, schwere Qualität

Creamer

18/10 stainless steel, mirror polished finish, heavy gauge



Art-Nr. Part No.	∅ dia. cm	Höhe Height cm
117/025	0,23 l 8	5



Zuckerdose

aus Edelstahl 18/10, hochglänzend, ohne Deckel, schwere Qualität

Sugar Bowl

18/10 stainless steel, mirror polished finish, heavy gauge



Art-Nr. Part No.	∅ dia. cm	Höhe Height cm
113/023	0,23 l 8	5



Zuckerdose mit Deckel

aus Edelstahl 18/10, hochglänzend, schwere Qualität

Sugar Bowl

18/10 stainless steel, mirror polished finish, with lid, heavy gauge



Sahnegießer

aus Edelstahl 18/10, außen hochglänzend

Creamer

18/10 stainless steel, outside mirror polished



Art-Nr. Part No.		Ø dia. cm	Höhe Height cm
505/003	0,03 l	3,5	3,5
505/005	0,05 l	4	4,2
505/009	0,09 l	4,8	5,2
505/015	0,15 l	6	6

Zuckerdose

aus Edelstahl, außen hochglänzend

Sugar Bowl

stainless steel, mirror polished outside



Art-Nr. Part No.		Ø dia. cm	Höhe Height cm
503/028	0,3 l	8,5	7

Sahnegießer

aus Edelstahl 18/10, hochglänzend

Creamer

18/10 stainless steel, mirror polished finish



Art-Nr. Part No.		Höhe Height cm
4620/015	0,15 l	7 cm
4620/030	0,28 l	8 cm

Zuckerdose

aus Edelstahl 18/10, hochglänzend, mit seitlichen Griffen und Scharnierdeckel mit Löffelausschnitt, schwere Qualität

Sugar Bowl

18/10 stainless steel, mirror polished finish, hinged lid notched for spoon, heavy gauge



Art-Nr. Part No.		Höhe Height cm
4615/015	0,15 l	7 cm
4615/030	0,3 l	8 cm

Sahnegießer

aus Edelstahl 18/10, hochglänzend

Creamer

18/10 stainless steel, mirror polished finish



Art-Nr. Part No.		Ø dia. cm	Höhe Height cm
mit offenem Griff: / with open handle:			
109/020	0,02 l	3	3
mit geschlossenem Griff: / with handle welded at both ends:			
109/030	0,03 l	3,5	3,5
109/050	0,05 l	4	4
109/100	0,1 l	5	5,5
109/150	0,15 l	5,5	6

Sahnegießer

mit Deckel, mit Griff, aus Edelstahl 18/10, hochglänzend, schwere Qualität

Creamer with Lid

18/10 stainless steel, mirror polished finish, heavy gauge



Art-Nr. Part No.		Ø dia. cm	Höhe Height cm
109/151	0,15 l	5,5	6,5



Art-Nr. Part No.	∅ max. cm	Höhe Height cm
Ohne Griff: / Without handle:		
8894/150	0,15 l	6,5
Mit Griff: / With gold plated handle:		
8894/151	0,15 l	6,5



Gold

Sahnegießer/ Milchkönnchen
aus Edelstahl 18/10, hochglänzend, wahlweise ohne oder mit vergoldetem Griff, schwere Qualität

Creamer
18/10 stainless steel, mirror polished finish, heavy gauge



Art-Nr. Part No.	∅ max. cm	Höhe Height cm
Ohne Griffe: / Without handles:		
8895/150	0,25 l	9
Mit vergoldeten Griffen: / With gold plated handles:		
8895/151	0,25 l	9
Deckel mit vergoldetem Griffknopf bitte separat bestellen: / Please order lids with gold plated knob separately:		
8899/070	7	
Deckel mit Griffknopf bitte separat bestellen: / Please order lids with knob separately:		
6899/070	7	



Gold

Zuckerdose
aus Edelstahl 18/10, hochglänzend, wahlweise ohne oder mit vergoldeten Griffen, schwere Qualität

Sugar Bowl
18/10 stainless steel, mirror polished finish, heavy gauge



Art-Nr. Part No.	∅ dia. cm	Höhe Height cm
3023/015	50 ml	4



Sahnegießer
in klassischer Milchkanneform, aus Edelstahl 18/10, hochglänzend poliert, mit aufklappbarem Deckel, hochwertig verarbeitet

Mini Milk Churn
18/10 stainless steel, mirror polished finish, with lid fixed on ring, perfect for pouring cream, high quality



Art-Nr. Part No.	∅ dia. cm	Höhe Height cm
107/030	0,03 l	3,5



Sahnegießer
aus Edelstahl, hochglänzend, mit Ausgusschnaupe, ohne Griff

Cream Jug
stainless steel, mirror polished finish, with spout, without handle



Art-Nr. Part No.	Länge Length cm	Breite Width cm	Höhe Height cm	∅ max. cm
1024/004	15	10	23	4



Ständer für Kaffeemilchportionen
aus matt poliertem Edelstahl, mit vier offenen Röhren für etwa 24 Kaffeesahneportionen, Schongummi unter dem Standfuß

Milk Portion Dispenser
stainless steel, satin polished, for approximately 24 portions, rubber coated base



Frühstücksmenage

Kiste aus Fichtenholz, bestückt mit Salz- und Pfefferstreuer, Zuckerstreuer, Bügelflasche für Milch

Breakfast Cruet Set

wooden box, equipped with salt and pepper pots, sugar shaker, flip top bottle for milk



Art-Nr. Part No.	Länge gesamt Total Length cm	Breite Width cm	Höhe Height cm
---------------------	------------------------------------	-----------------------	----------------------

PRODUKTION
EINGESTELLT
PRODUCTION
DISCONTINUED

Serviceartikel

Eine große Anzahl von Gästen möchte schnell und aufmerksam bedient werden. Angefangen von Tablettts für den sicheren Transport der Getränke und Speisen bis hin zu Körben und Kannen für den Service oder die Selbstbedienung der Gäste. Hier finden die Servicekräfte alles, was den täglichen Arbeitsablauf erleichtert.

Service

Serving guests quickly and attentively is important. From trays for carrying food and drinks quickly and safely to baskets and beverage servers designed for high demand, front of house staff will find everything they need to make their day to day work easier.

Seite Page
380

Kannen
Jugs & Pots



Seite Page
390

Serviertabletts & Clochen
Trays, Cloches & Plate Covers



Seite Page
402

Körbe, Natur
Willow Baskets



Seite Page
405

Körbe, Edelstahl
Stainless Steel Baskets



Seite Page
408

Körbe, Polypropylen
Polypropylene Baskets



Seite Page
411

Tischaccessoires
Front of House Accessories





Kannen

Hier wird das Thema Kaffee- und Getränkeservice groß geschrieben! Von Kaffee Kannen und Barista-Utensilien über Teezubehör bis zu Flaschenkühlern und Glaskaraffen.

Jugs & Pots

Quality tea and coffee is key to good service.

contacto's range of jugs and pots will help ensure this can be achieved.

Kaffeekanne

aus Edelstahl 18/10, hochglänzend,
mit Einhand-Klappdeckel, schwere Qualität

Coffee Pot

18/10 stainless steel, mirror polished, with lid,
heavy gauge

18/10
EDELSTAHL
STAINLESS STEEL



Art-Nr. Part No.		∅ Boden ∅ Base cm	Höhe Height cm
3020/030	0,3 l	7,5	10
3020/060	0,65 l	9,5	12

Milch-/Wasserkanne

aus Edelstahl 18/10, hochglänzend, schwere Qualität

Milk/Water Jug

18/10 stainless steel, mirror polished, heavy gauge

18/10
EDELSTAHL
STAINLESS STEEL



Art-Nr. Part No.		∅ Boden ∅ Base cm	Höhe Height cm
3022/030	0,3 l	7,5	10
3022/060	0,65 l	9,5	12

Sahnegießer

aus Edelstahl 18/10, hochglänzend,
extra schwere Qualität

Creamer

18/10 stainless steel, mirror polished finish,
extra heavy gauge

18/10
EDELSTAHL
STAINLESS STEEL



Art-Nr. Part No.		∅ dia. cm	Höhe Height cm
Ohne Deckel: / Without lid:			
3019/010	0,1 l	5	6,5
Mit Einhand-Klappdeckel: / With hinged lid:			
3019/019	0,1 l	5	6,7

Kannen

Tea and Coffee Pots and Jugs



contacto

Art-Nr. Part No.	Höhe Height
100/035	0,3 l / 10,5 cm
100/060	0,6 l / 13 cm
100/100	0,9 l / 15 cm
100/150	1,5 l / 19 cm
100/200	2 l / 21 cm

Literangaben auf der Verpackung können vom obigen tatsächlichen Volumen abweichen.

Capacity shown on the packaging can differ from the actual volume of the pots indicated above.



Kaffeekanne

aus Edelstahl 18/10, hochglänzend, mit Scharnierdeckel

Coffee Pot

18/10 stainless steel, mirror polished finish, with hinged lid

18/10
EDELSTAHL
STAINLESS STEEL

Art-Nr. Part No.	Höhe Height
110/035	0,3 l / 10 cm
110/060	0,6 l / 11 cm
110/100	0,9 l / 13 cm
110/150	1,5 l / 17 cm

Literangaben auf der Verpackung können vom obigen tatsächlichen Volumen abweichen.

Capacity shown on the packaging can differ from the actual volume of the pots indicated above.



Teekanne

aus Edelstahl 18/10, hochglänzend, mit Innensieb, mit Scharnierdeckel

Tea Pot

18/10 stainless steel, mirror polished finish, with built-in strainer, with hinged lid

18/10
EDELSTAHL
STAINLESS STEEL

Art-Nr. Part No.	Höhe Height
105/015	0,15 l / 5,5 cm
105/035	0,3 l / 9 cm
105/060	0,6 l / 11 cm
105/100	0,9 l / 12,5 cm
105/150	1,5 l / 16 cm
105/200	2 l / 18 cm

Literangaben auf der Verpackung können vom obigen tatsächlichen Volumen abweichen.

Capacity shown on the packaging can differ from the actual volume of the pots indicated above.



Milch-/Wasserkanne

aus Edelstahl 18/10, hochglänzend

Milk/Water Jug

18/10 stainless steel, mirror polished finish

18/10
EDELSTAHL
STAINLESS STEEL

Art-Nr. Part No.	Höhe Height
103/035	0,3 l / 9,5 cm
103/060	0,6 l / 11 cm
103/100	0,9 l / 12,5 cm



Antihaft-Milchkanne

aus Edelstahl, mit PTFE Beschichtung, besonders geeignet zum Herstellen, Ausgießen von Milchschaum für den Barista; leicht zu reinigen, unempfindlich gegen Fingerabdrücke

Non-Stick Jug

stainless steel, PTFE-coated, particularly suitable for baristas frothing hot milk, easy to clean, doesn't show up finger marks

INOX
EDELSTAHL
STAINLESS STEEL

PTFE
ANTHAFET
NON-STICK

Kaffeekanne

aus Edelstahl 18/10, hochglänzend, mit Scharnierdeckel, Griffe stumpf angebracht - daher absolut hygienisch, extra schwere Qualität

Coffee Pot

18/10 stainless steel, mirror polished finish, with hinged lid, extra heavy gauge

18/10
EDELSTAHL
STAINLESS STEEL



Art-Nr. Part No.		Höhe Height
3017/030	0,3 l	11 cm
3017/060	0,6 l	15 cm
3017/100	1 l	18 cm
3017/150	1,5 l	20,5 cm
3017/200	2 l	21,5 cm
3017/300	3 l	25 cm

3017/301*	3 l	25,5 cm
3017/501*	5 l	29 cm

*mit zusätzlichem Tragebügel

*with extra loop handle

Teekanne

aus Edelstahl 18/10, hochglänzend, mit Scharnierdeckel und Innensieb, Griffe stumpf angebracht - daher absolut hygienisch, extra schwere Qualität

Tea Pot

18/10 stainless steel, mirror polished finish, with built in strainer, with hinged lid, extra heavy gauge

18/10
EDELSTAHL
STAINLESS STEEL



Art-Nr. Part No.		Höhe Height
3018/030	0,3 l	10 cm
3018/060	0,6 l	15,5 cm
3018/100	1 l	17,5 cm
3018/150	1,5 l	19,5 cm
3018/200	2 l	21 cm
3018/300	3 l	25 cm
3018/501*	5 l	30 cm

*mit zusätzlichem Tragebügel

*with extra loop handle

Milch-/Wasserkanne

aus Edelstahl 18/10, hochglänzend, Griffe stumpf angebracht - daher absolut hygienisch, extra schwere Qualität

Milk/Water Jug

18/10 stainless steel, mirror polished finish, extra heavy gauge

18/10
EDELSTAHL
STAINLESS STEEL



Art-Nr. Part No.		Höhe Height
3016/030	0,3 l	10 cm
3016/060	0,6 l	13,5 cm
3016/100	1 l	16 cm
3016/150	1,5 l	17 cm
3016/200	2 l	18,5 cm
3016/300	3 l	23 cm
3016/500	5 l	26 cm

Kannen

Tea and Coffee Pots and Jugs



Art-Nr. Part No.	∅ dia. cm	Höhe Height cm
502/035	0,3 l	7,5
502/060	0,5 l	8,5
502/100	0,8 l	10
502/150	1,3 l	12
502/220	1,8 l	12,5
502/300	2,8 l	14,5

Literangaben auf der Verpackung können vom obigen tatsächlichen Volumen abweichen.

Capacity shown on the packaging can differ from the actual volume of the pots indicated above.



Kaffeekanne

aus Edelstahl 18/10, hochglänzend, mit Ausgussieb, mit Scharnierdeckel

Coffee Pot

18/10 stainless steel, mirror polished finish, with built in strainer and hinged lid

18/10
EDELSTAHL
STAINLESS STEEL

Art-Nr. Part No.	∅ dia. cm	Höhe Height cm
504/035	0,3 l	8,5
504/060	0,5 l	10
504/100	0,8 l	11,5
504/150	1,3 l	12,5
504/220	1,8 l	14,5
504/300	2,8 l	14,5

Literangaben auf der Verpackung können vom obigen tatsächlichen Volumen abweichen.

Capacity shown on the packaging can differ from the actual volume of the pots indicated above.



Teekanne

aus Edelstahl 18/10, hochglänzend, mit Ausgussieb, mit Scharnierdeckel

Tea Pot

18/10 stainless steel, mirror polished finish, with built in strainer and hinged lid

18/10
EDELSTAHL
STAINLESS STEEL

Art-Nr. Part No.	∅ dia. cm	Höhe Height cm
506/060	0,5 l	8,5
506/100	0,8 l	10
506/150	1,3 l	12
506/200	1,8 l	12,5
506/300	2,8 l	14,5

Literangaben auf der Verpackung können vom obigen tatsächlichen Volumen abweichen.

Capacity shown on the packaging can differ from the actual volume of the pots indicated above.



Milch- /Wasserkanne

aus Edelstahl 18/10, hochglänzend

Milk/Water Jug

18/10 stainless steel, mirror polished finish

18/10
EDELSTAHL
STAINLESS STEEL

Art-Nr. Part No.	Höhe Height
202/035	0,35 l 10 cm



Kaffeekanne

aus Edelstahl 18/10, hochglänzend, mit Ausgussieb und Scharnierdeckel

Coffee Pot

18/10 stainless steel, mirror polished finish, with built in strainer and hinged lid

18/10
EDELSTAHL
STAINLESS STEEL

Art-Nr. Part No.	Höhe Height
204/035	0,35 l 10 cm



Teekanne

aus Edelstahl 18/10, hochglänzend, mit Ausgussieb und Scharnierdeckel

Tea Pot

18/10 stainless steel, mirror polished finish, with built in strainer and hinged lid

18/10
EDELSTAHL
STAINLESS STEEL

Isoliertes Kaffeeännchen

zylindrische Form, aus Edelstahl 18/10, hochglänzend, doppelwandig, stapelbar, mit Einhand-Klappdeckel, spülmaschinenfest, schwere Qualität

Insulated Beverage Server

double walled, 18/10 stainless steel, mirror polished finish, stackable, with hinged lid, dishwasher safe, heavy gauge



Art-Nr. Part No.		∅ max. cm	Höhe Height cm
5156/030	0,3 l	8,7	10

Isoliertes Kaffeeännchen

aus Edelstahl 18/10, seidenmatt poliert, doppelwandig, mit Einhand-Klappdeckel, spülmaschinenfest, schwere Qualität

Insulated Beverage Server

double walled, 18/10 stainless steel, satin polished finish, with hinged lid, dishwasher safe, heavy gauge



Art-Nr. Part No.		∅ Boden Base cm	Höhe Height cm
5154/030	0,3 l	10	9,5

Isolierkanne

innen und außen aus Edelstahl 18/10, hochglänzend, doppelwandig, mit verchromtem Griff, schwere Qualität

Insulated Beverage Server

double walled, 18/10 stainless steel, mirror polished finish, with hinged lid, chrome plated handle, heavy gauge



Art-Nr. Part No.		Höhe Height cm
5151/060	0,6 l	19 cm
5151/100	0,9 l	20 cm
5151/150	1,4 l	26 cm

Literangaben auf der Verpackung können vom obigen tatsächlichen Volumen abweichen. Die Kannen sind nicht spülmaschinengeeignet. Capacity shown on the packaging can differ from the actual volume of the pots indicated above. The jugs are not dishwasher proof.

Schild für Kannen

aus Edelstahl 18/0, hochglänzend poliert, an 10 cm langer Kette, ein- oder beidseitige Standard- oder individuelle Beschriftung durch spülmaschinenfeste Laserung

Tea and Coffee Sign

18/0 stainless steel, mirrored polished, on 10 cm long chain, the text will be lasered on one or both sides either with standard words or individually



Art-Nr. Part No.	Länge Length cm	Breite Width cm
7229/950	5	2,5

Ausführung ohne Markierung
Version without wording

7229/001	KAFFEE
7229/002	TEE

7229/101	COFFEE
7229/102	TEA

7229/801	mit individueller Beschriftung / with individual sign
----------	--

Bitte suchen Sie die Artikelnummern zu weiteren Textvarianten auf contacto.de oder geben Sie den gewünschten Text bei der Bestellung an. Auf Wunsch gleiche Markierung auch auf der Rückseite des Schildes ohne zusätzliche Berechnung. Please find the item codes for other words on contacto.de or mention the required text in your order. Marking on both sides without additional costs on request.

Isolierte Kannen

Insulated Beverage Servers



contacto

Art-Nr. Part No.	Ø dia.	Höhe gesamt Overall Height
	cm	cm
5161/120	1,2 l	14 21
5161/150	1,5 l	14 23
5161/200	2 l	14 26,5

Teefiltereinsatz / Tea Infuser:
5161/707

Ersatzdeckel: / Spare Lid:
5161/901

Die Kannen sind nicht spülmaschinengeeignet.
The jugs are not dishwasher proof.



Isolierkanne

innen und außen aus Edelstahl, seidenmatt poliert, verchromter Griff, mit schwarzem Deckel, großer Daumendruck-Mechanismus ermöglicht das Ausgießen ohne Öffnen des Deckels, große Öffnung zum Einsetzen unter Kaffeemaschinen

Insulated Beverage Server

all stainless steel, satin polished finish, with chrome plated black plastic handle and lid, with easy push button for serving beverage without opening the lid, large opening to fit coffee machines



Art-Nr. Part No.	Ø dia.	Höhe gesamt Overall Height
	cm	cm
5160/100	1 l	14 19
5160/150	1,5 l	14 23
5160/200	2 l	14 24,5

5160/906 Ersatzdeckel / Spare lid

Die Kannen sind nicht spülmaschinengeeignet.
The jugs are not dishwasher proof.



Isolierkanne

innen und außen aus Edelstahl, matt poliert, mit schwarzem Griff und Verschluss, Daumendruck-Mechanismus ermöglicht das Ausgießen ohne Öffnen des Deckels

Insulated Beverage Server

all stainless steel, matt polished finish, with black plastic handle and lid, with easy push button for serving beverage without opening the lid



Art-Nr. Part No.	Ø dia.	Höhe gesamt Overall Height
	cm	cm
5166/220	2,2 l	15 34
5166/300	3 l	15 36

Die Kannen sind nicht spülmaschinengeeignet.
The jugs are not dishwasher proof.



Isolierte Pumpkanne

innen und außen aus Edelstahl, seidenmatt gebürstet, mit Griff und Verschluss aus schwarzem Kunststoff, mit Pumpmechanismus

Insulated Airpot

all stainless steel, satin polished finish, handle and seal made of black plastic, vacuum insulated double walled, with pump mechanism



Kaffeessatz-Lade

aus Edelstahl, hochglänzend, zum Ausklopfen von Kaffeessatz, Walze innen aus blauem Kunststoff, vorstehender Griff, mit Gummifüßen

Knock-Out Drawer

stainless steel, mirror polished, with rubber feet, and blue hard plastic tubular bar, for collecting coffee grounds



Art-Nr. Part No.	Breite außen Outer Width cm	Höhe außen Outer Height cm	Tiefe max. Depth max. cm
7225/300	30	9,5	40
7225/901	Ersatzrolle / Spare roll		

Kaffeessatz-Lade

aus Edelstahl, hochglänzend, zum Ausklopfen von Kaffeessatz, rollengelagerte Schublade, Griffmulde in Blende, Walze innen aus blauem Kunststoff, mit angenieteten Gummifüßen

Knock-Out Drawer

stainless steel, mirror polished, with roller bearings for drawer recessed grip in front panel, with riveted rubber feet and blue plastic tubular bar, for collecting coffee grounds



Art-Nr. Part No.	Breite außen Outer Width cm	Höhe außen Outer Height cm	Tiefe max. Depth max. cm
7226/225	22,5	11,5	40
7226/902	Ersatzrolle / Spare roll		

Abschlagrolle

aus Edelstahl, mit Abklopfwalze aus Polyethylen, universell in alle Behälter GN 1/6 einhängbar, verwandelt diese in einen Abschlagbehälter für Kaffeessatz, kann zum Reinigen einfach abgenommen werden, spülmaschinengeeignet

Knock Box Bar

stainless steel wire inside, polyethylene tubular bar, for removing coffee grounds, fits all GN 1/6 container, can easily be removed for cleaning, dishwasher safe



Art-Nr. Part No.	GN	Tiefe Depth cm
7040/016	1/6	

Passender Behälter GN 1/6 bitte separat bestellen: / Please order 1/6 GN container separately:

7016/100	1/6	10
7016/150	1/6	15
7016/200	1/6	20

Kaffeportionierer

aus Edelstahl 18/10, mit flachem Griff, hochglänzend, schwere Qualität

Coffee Portioner

18/10 stainless steel, flat handle, mirror polished finish, heavy gauge



Art-Nr. Part No.	Ø dia. cm	Stiellänge Handle Length cm
Für etwa 7 g Kaffee (Tasse): / for about 7g coffee (cup)		
1817/040	1,8 cl	3,8

Für etwa 35 g Kaffee (Kanne): / for about 35g coffee (pot)		
1817/060	9 cl	6
		21

Kaffeportionierer

aus Edelstahl 18/10, hochglänzend, mit stabilem 3 mm starkem Drahtgriff, schwere Qualität

Coffee Portioner

18/10 stainless steel, mirror polished, solid 3 mm thick wire handle, heavy gauge



Art-Nr. Part No.	Ø dia. cm	Stiellänge Handle Length cm
Für etwa 7 g Kaffee (Tasse): / for about 7g coffee (cup)		
1813/038	1,8 cl	3,8
		10

Art-Nr. Part No.	∅ Teller ∅ Plate cm	Höhe gesamt Overall Height cm
---------------------	---------------------------	-------------------------------------

Mokka-/Espresso-Tasse: / espresso:			
5140/001	0,08 l	12	6

Kaffee-/Cappuccino-Tasse: / cappuccino:			
5140/002	0,18 l	13,5	7,5



Espresso-/ Cappuccinotasse
doppelwandig, aus Edelstahl, hochglänzend,
mit Untertasse

Coffee Cup & Saucer
insulated double walled cup, stainless steel,
mirror polished finish



Art-Nr. Part No.	∅ dia. cm	Höhe Height cm
---------------------	-----------------	----------------------

1270/002	0,25 l	6	13,5
----------	--------	---	------

Preis und Verpackung à 2 Stück.
Priced and packed in pairs.

Ersatzglas: / Spare glass:	
1270/902	0,25 l

Pflegehinweis: Glas zur Reinigung nur nach oben herausziehen.
To remove for cleaning please pull glass upwards only.



Irish Coffee Gläser-Set
Set mit 2 Stück, aus Edelstahl 18/10, seidenmatt
gebürstet, mit schwerem Glaseinsatz, für Tee,
heiße Zitrone, Grog, Irish Coffee usw.,
mit Untersetzer und Trinklöffel

Lemon Tea/ Latte Glass Set
18/10 stainless steel, satin polished brushed finish,
with heavy glass, top quality, also suitable for mulled
wine etc.



Art-Nr. Part No.	Länge Length cm
---------------------	-----------------------

1277/200	20
----------	----



Latte Macchiato Löffel
aus Edelstahl 18/10, mit Prägung "Latte" auf dem Griff

Latte spoon
18/10 stainless steel, stamped "Latte"



Art-Nr. Part No.	Länge Length cm
---------------------	-----------------------

2088/001	20 cm
----------	-------



Latte Macchiato Löffel
aus Edelstahl 18/10, mit Knick zum Einhängen am Glas

Latte spoon
18/10 stainless steel, bended to hang up in glasses



Art-Nr. Part No.	∅ dia. cm	Höhe Height cm	Stiellänge Handle Length cm
---------------------	-----------------	----------------------	-----------------------------------

1025/025	0,25 l	6	10	10
1025/050	0,5 l	8,5	11,5	12,5
1025/100	1 l	10	15	12,5



Milchaufschäumer
aus Edelstahl 18/10, hochglänzend, mit Graduierung

Milk Steamer/Frother
18/10 stainless steel, mirror polished finish, graduated



Teeglas-Set

Set mit 0,15 l-Glas, Halter und Trinkhalmlöffel aus Edelstahl 18/10, Untersatz aus Edelstahl 18/0, hochglänzend poliert

Tea Glass and Holder

18/10 stainless steel holder and spoon,
18/0 stainless steel coaster, mirror polished finish



Art-Nr. Part No.	∅ dia. cm	Höhe Height cm
569/150	0,15 l	6 8,5

Teebeutelklammer

aus Edelstahl 18/0, hochglänzend poliert,
verhindert das Hineinrutschen des Beutelfadens,

Tea Bag Clip

18/0 stainless steel, mirror polished,
prevents tea bags from slipping into the glass,



Art-Nr. Part No.	Breite Width cm	Länge Length cm
3303/040	1,3	4

Abgebildetes Glas gehört nicht zum Lieferumfang.
Supplied without mug.

Teesieb mit Schale

aus Edelstahl 18/10, hochglänzend poliert, für Tassen
mit max. ∅ 11 cm, mit Tropfschälchen, schwere Qualität

Tea Strainer with Bowl

18/10 stainless steel, mirror polished finish, for cups
max. ∅ 11 cm, with drainer bowl, heavy gauge



Art-Nr. Part No.	∅ innen ∅ Inside cm	Länge gesamt Total Length cm
3122/125	4,5	12,5

Teesiebblöfel

aus Edelstahl 18/10, hochglänzend

Tea Infuser

18/10 stainless steel, mirror polished finish



Art-Nr. Part No.	Löffelmaß Bowl Size cm	Länge Length cm
138/150	5,5 x 4	15,5

Tee-Ei

aus Edelstahl 18/10, hochglänzend,
mit Schraubverschluss, mit 11 cm langer Kette

Tea Infuser

18/10 stainless steel, mirror polished finish,
screw locked, 11 cm chain



Art-Nr. Part No.	∅ dia. cm
3302/040	4 cm

Teebrühsieb

aufklappbar, aus Edelstahl 18/10, mit feinem Sieb

Tea Infuser

18/10 stainless steel, with fine mesh



Art-Nr. Part No.	Länge Length cm	∅ dia. cm
3125/150	15 cm	4,5 cm
3125/175	17,5 cm	6,5 cm

Art-Nr. Part No.	∅ dia.	Höhe Height
222/080	9 cm	9,5 cm



Besteckhalter

aus Edelstahl 18/10, außen hochglänzend
innen elektrolytisch poliert, schwere Qualität

Cutlery Container

18/10 stainless steel, outside mirror polished,
inside electro-polished, heavy gauge



Art-Nr. Part No.	Länge Length	Breite Width	Höhe gesamt Overall Height
	cm	cm	cm

Mit zwei Bechern: / with 2 containers:

220/002 16,5 8 10,5

Mit drei Bechern: / with 3 containers:

220/003 26 8 12



Besteckhalter

aus Edelstahl 18/10, außen hochglänzend,
innen matt poliert, mit fest fixierten Bechern

Spoon Container Set

18/10 stainless steel, outside mirror,
inside matt polished, with fixed containers



Art-Nr. Part No.	Höhe Height	∅ innen ∅ Inside	
	cm	cm	
2080/100	10	8	0,5 l
2080/140	14	8	0,7 l



Limonadenlöffel-Halter

aus Edelstahl 18/10, außen seidenmatt poliert,
innen hochglänzend, mit kleinem offenen Rand,
universell einsetzbarer Behälter für Löffel, Trinkhalme,
Dressings u.ä., schwere Qualität

Spoon Container

18/10 stainless steel, outside satin polished,
inside mirror polished, small open edge,
multi purpose for sundae spoons, drinking straws,
dressings etc., heavy gauge



Art-Nr. Part No.	∅ Einbau ∅ Cut Out	∅ außen ∅ Outside	Höhe Height
	cm	cm	cm
2320/100	7	8,5	10
2320/150	7	8,5	15



Besteckköcher

passend zu Besteckträger 257, aus Edelstahl 18/10,
schwere Qualität

Cutlery Cylinder

matches holder 257, 18/10 stainless steel, heavy gauge



Art-Nr. Part No.	∅ dia.	Höhe Height	
	cm	cm	
1443/130	14	12,5	1,3 l

4492/345 Wachspapier / greaseproof paper



Eimer, klein

aus verzinktem Blech, mit Tragebügel aus Draht,
wasserdicht, aber nicht lebensmittelgeeignet,
zur Aufbewahrung von Servietten oder Dekorations-
gegenständen, leichte Qualität

Mini Bucket

zinc plated, with wire handle, watertight, ideal for
storing napkins or decorations, not suitable for food
without greaseproof paper such as 4492/345



Serviertablets & Clochen

Ob groß oder klein; eckig oder rund, glatt oder beschichtet - hier finden Sie die passenden Tablets für jegliche Ansprüche, Ambiente und einen sicheren Service.

Trays, Cloches & Plate Covers

contacto offers a large variety of trays, plate covers and cloches catering for your every need and function.

Tablett GN (Gastronorm)

aus glasfaserverstärktem Polyesterharz, spülmaschinenfest, robust, formbeständig, temperaturbeständig von -50°C bis +140°C, mit Stapelnocken und Randverstärkung, Monoblockaufbau, hohe mechanische und chemische Resistenz, geeignet für automatische Stapelung

Gastronorm Trays

fibreglass reinforced polyester, with reinforced edges & drying/stacking lugs, dishwasher proof, temperature resistant from -50°C to +140°C, resistant to food acids, alcohol and UV light, extremely robust, virtually unbreakable



Art-Nr. Part No.	Länge Length cm	Breite Width cm	Höhe Height cm	Farbe Colour
---------------------	-----------------------	-----------------------	----------------------	-----------------

Gastronorm GN 1/1 (DIN 18874 - A1) / Gastronorm GN 1/1:				
4511/001	53	32,5	1,6	lichtgrau/light grey
4511/004	53	32,5	1,6	weiß/white
4511/005	53	32,5	1,6	granitgrau/granite
4511/006	53	32,5	1,6	melba/peach

Gastronorm GN 1/2 (DIN 18874 - A2) / Gastronorm GN 1/2:				
4512/001	32,5	26,5	1,6	lichtgrau/light grey
4512/005	32,5	26,5	1,6	granitgrau/granite



Tablett, rutschfest

aus schwarzem glasfaserverstärktem Polyesterharz, rutschfeste Beschichtung aus Gummi, daher nicht spülmaschinenfest, robust, formbeständig, temperaturbeständig von -50°C bis +140°C, mit Stapelnocken und Randverstärkung, Monoblockaufbau, hohe mechanische und chemische Resistenz, geeignet für automatische Stapelung

Non-Slip-Tray

black fibreglass reinforced polyester, with reinforced edges & drying/stacking lugs, non-slip rubber surface, therefore not dishwasher proof, temperature resistant from -50°C to +140°C, resistant to food acids, alcohol and UV light, extremely robust, virtually unbreakable



Art-Nr. Part No.	Länge Length cm	Breite Width cm	Höhe Height cm	GN
---------------------	-----------------------	-----------------------	----------------------	----

Gastronorm GN 1/1 (DIN 18874-A1) / Gastronorm GN 1/1:				
4511/907	53	32,5	1,6	1/1

Gastronorm GN 1/2 (DIN 18874-A2) / Gastronorm GN 1/2:				
4512/907	32,5	26,5	1,6	1/2

Euronorm (DIN 18874-A4) / Euronorm:				
4411/907	53	37	1,6	



Tablett, EN (Euronorm)

aus glasfaserverstärktem Polyesterharz, spülmaschinenfest, robust, formbeständig, temperaturbeständig von -50°C bis +140°C, mit Stapelnocken und Randverstärkung, Monoblockaufbau, hohe mechanische und chemische Resistenz, geeignet für automatische Stapelung

Euronorm Trays

fibreglass reinforced polyester, with reinforced edges & drying/stacking lugs, dishwasher proof, temperature resistant from -50°C to +140°C, resistant to food acids, alcohol and UV light, extremely robust, virtually unbreakable



Art-Nr. Part No.	Länge Length cm	Breite Width cm	Höhe Height cm	Farbe Colour
---------------------	-----------------------	-----------------------	----------------------	-----------------

Euronorm Tablett (DIN 18874 - A4) / Euronorm:				
4411/001	53	37	1,6	lichtgrau/light grey
4411/004	53	37	1,6	weiß/white
4411/005	53	37	1,6	granitgrau/granite
4411/006	53	37	1,6	melba/peach



Kantinentabletts

Fast Food/Canteen Trays



Art-Nr. Part No.	Länge Length cm	Breite Width cm	Höhe Height cm	Farbe Colour
5354/002	46	36	2,5	lichtgrau/light grey
5354/005	46	36	2,5	granitgrau/granite



Kantinen-Tablett

aus glasfaserverstärktem Polyester, schlagfest und bruchstabil, spülmaschinenfest, temperaturresistent von -50°C bis +140°C, säure-, laugen- und UV-beständig, im Stapel belüftbar

Canteen Tray

fibreglass reinforced black polyester, dishwasher proof, temperature resistant from -50°C to +140°C, resistant to food, acids, alcohol & UV light, virtually unbreakable



Art-Nr. Part No.	Länge Length cm	Breite Width cm	Höhe Height cm
5326/460	46	35,5	2,2



Kantinen-Tablett, rutschfest

aus glasfaserverstärktem Polyesterharz, spülmaschineneignet, robust, formbeständig, mit rutschfester Folie beschichtet

Rectangular Tray

non slip, fibreglass reinforced polyester, dishwasher proof



Art-Nr. Part No.	Länge Length cm	Breite Width cm	Farbe Colour
5366/480	48	34	lichtgrau/light grey
5366/485	48	34	granitgrau/granite
5366/486	48	34	melba/peach



Kantinen-Tablett

Trapezform, aus glasfaserverstärktem Polyesterharz, spülmaschineneignet, robust, formbeständig, temperaturbeständig von -50°C bis +140°C, mit Stapelnocken und Randverstärkung, Monoblockaufbau, hohe mechanische und chemische Resistenz, geeignet für automatische Stapelung

Tray

fibreglass reinforced polyester, with reinforced edges & drying/stacking lugs, dishwasher safe, withstands temperatures from -50°C to +140°C, resistant to food acids, alcohol and UV light, extremely robust, virtually unbreakable



Art-Nr. Part No.	Länge Length cm	Breite Width cm	Höhe Height cm	Farbe Colour
5353/351	35	26,5	2	rot/red
5353/401	40	30	2	rot/red
5353/001	45	35	2	rot/red
5353/002	45	35	2	grau/grey
5353/353	35	26,5	2	blau/blue
5353/403	40	30	2	blau/blue
5353/003	45	35	2	blau/blue
5353/004	45	35	2	braun/brown
5353/356	35	26,5	2	schwarz/black
5353/406	40	30	2	schwarz/black
5353/006	45	35	2	schwarz/black



Fast Food Tablett

aus Polypropylen, mit Stapelnocken, resistent gegen Säuren und Chemikalien, bedingt rutschfest, spülmaschineneignet bis ca. +80°C; nur kurzzeitig formbeständig bis +100°C

Fast Food Tray

polypropylene, with stacking lugs, textured surface reduces slippage, dishwasher proof up to +80°C, heat resistant up to +100°C for short duration, virtually unbreakable



Farbe grün auf Anfrage lieferbar.
Green available on request.

Tablett, rutschfest

aus gummilaminiertem Schichtstoff, unzerbrechlich, spülmaschinengeeignet bis +100°C, kälteresistent bis -10°C, auch im nassen Zustand absolut rutschfest, säure-, laugen und UV-beständig

Non Slip Rectangular Tray

laminated with rubber lining, virtually unbreakable, dishwasher safe, temperature resistant from -10 ° to +100°C, resistant to food acids, alcohol and UV light



Art-Nr. Part No.	Länge Length cm	Breite Width cm	Höhe Height cm	
Normgröße DIN 18874 - A6:				
5310/461	46	36	1,6	schwarz/black
5310/611	61	43	1,6	schwarz/black
5310/617	61	43	1,6	braun/brown

Tablett GN 1/1, rutschfest

aus gummilaminiertem Schichtstoff, unzerbrechlich, spülmaschinengeeignet bis +100°C, kälteresistent bis -10°C, auch im nassen Zustand absolut rutschfest, säure-, laugen und UV-beständig

Non Slip GN Tray 1/1

laminated with rubber lining, virtually unbreakable, dishwasher safe, temperature resistant from -10 ° to +100°C, resistant to food acids, alcohol and UV light



Art-Nr. Part No.	Länge Length cm	Breite Width cm	Höhe Height cm	
Gastronorm GN 1/1 (DIN 18874 - A1): / Gastronorm GN 1/1:				
5311/531	53	32,5	1,6	schwarz/black
5311/533	53	32,5	1,6	blau/blue
5311/539	53	32,5	1,6	signalrot/red

Tablett, rutschfest

aus braunem ABS-Kunststoff, hitzeresistent bis +80°C, spülmaschinengeeignet, sehr robuste, langlebige Spezialbeschichtung mit Korkanteil, temperaturbelastbar bis ca. +150°C, alkohol- und fettresistent

Serving Tray, non slip

brown ABS plastic, dishwasher proof up to +80°C, cork surface, withstands heat up to +150°C, alcohol and fat-resistant



Art-Nr. Part No.	Länge Length cm	Breite Width cm	Höhe Height cm	Farbe Colour
3773/415	41,5	30	2,3	braun/brown
3773/455	45,5	34	2,3	braun/brown

Tablett GN 1/1

rechteckige Form, aus melaminbeschichtetem 3 mm starkem Pressholz, mahagonifarben, säureresistent

Gastronorm 1/1 Tray

melamine coated wood, mahogany design, resistant to food acids and alcohol



Art-Nr. Part No.	Länge Length cm	Breite Width cm	Höhe Height cm	Farbe Colour
Gastronorm GN 1/1 (DIN 18874 - A1): / Gastronorm GN 1/1:				
3511/001	53	32,5	1,8	mahagoni/mahogany

Die Tablett sind nur bedingt spülmaschinengeeignet.
Trays are not suitable for permanent dishwasher use.

Tablett GN 1/1, rutschfest

aus melaminbeschichtetem 3 mm starkem Pressholz, mahagonifarben, säureresistent

Gastronorm 1/1 Tray, non slip

melamine coated wood, mahogany design, resistant to food acids and alcohol



Art-Nr. Part No.	Länge Length cm	Breite Width cm	Höhe Height cm	Farbe Colour
Gastronorm GN 1/1 (DIN 18874 - A1): / Gastronorm GN 1/1:				
3504/001	53	32,5	1,8	mahagoni/mahogany

Die Tablett sind nur bedingt spülmaschinengeeignet.
Trays are not suitable for permanent dishwasher use.



Art-Nr. Part No.	Länge Length cm	Breite Width cm	Höhe Height cm	Farbe Colour
---------------------	-----------------------	-----------------------	----------------------	-----------------

Gastronorm GN 1/1 (DIN 18874 - A1): / Gastronorm GN 1/1:
3311/530 53 32,5 1,7 nussbaum/walnut



Serviertablett GN 1/1

aus melaminbeschichtetem 3 mm starkem Pressholz, nussbaumfarben, spülmaschinengeeignet, schlagfest und bruchstabil, temperaturresistent von -10°C bis +100°C, säure-, laugen-, UV-beständig

Gastronorm 1/1 Tray

melamine coated wood, dishwasher safe, walnut design, temperature resistant from -10°C to +100°C, resistant to food acids, alcohol and UV light, virtually unbreakable



Art-Nr. Part No.	Länge Length cm	Breite Width cm	Höhe Height cm	Farbe Colour
---------------------	-----------------------	-----------------------	----------------------	-----------------

3401/440 44 32 1,7 nussbaum/walnut
3401/460 46 36 1,5 nussbaum/walnut
3401/520 52 39 1,5 nussbaum/walnut
3401/610 61 43 1,7 nussbaum/walnut

Mit zusätzlicher rutschfester Beschichtung: / with non-slip coating

3401/444* 44 32 1,7 nussbaum/walnut

*nicht spülmaschinengeeignet

*not dishwasher safe



Serviertablett

aus melaminbeschichtetem 3 mm starkem Pressholz, Nussbaum-Dekor, spülmaschinengeeignet (ausgenommen rutschfestes Tablett), schlagfest und bruchstabil, temperaturresistent von -10°C bis +100°C, säure-, laugen-, UV-beständig

Serving Tray

melamine coated walnut, dishwasher safe (except non-slip trays), temperature, walnut wood design, resistant from -10°C to +100°C resistant to food acids, alcohol and UV light, virtually unbreakable



Art-Nr. Part No.	Länge Length cm	Breite Width cm	Höhe Height cm	Farbe Colour
---------------------	-----------------------	-----------------------	----------------------	-----------------

Normgröße DIN 18874-A6

3501/460 46 35 1,8 mahagoni/mahogany

3501/600 60 45 1,8 mahagoni/mahogany



Kantinen-Tablett, rutschfest

aus melaminbeschichtetem 3 mm starkem Pressholz, mahagonifarben, spülmaschinengeeignet, schlagfest und bruchstabil, temperaturresistent von -10°C bis +100°C, säure-, laugen-, UV-beständig

Canteen Tray, non slip

melamine coated wood, dishwasher safe, mahogany coloured, temperature resistant from -10°C to +100°C, resistant to food acids, alcohol and UV light, virtually unbreakable



Art-Nr. Part No.	Länge Length cm	Breite Width cm	Höhe Height cm	Farbe Colour
---------------------	-----------------------	-----------------------	----------------------	-----------------

3405/470 47 32 1,5 nussbaum/walnut

Mindestgröße des Tisches bei vier Tablett: 86 cm.

Minimum size of table 86 cm, if 4 trays are used.



Tablett

Trapezform, aus melaminbeschichtetem 3 m-Pressholz mit Nussbaum-Dekor, spülmaschinengeeignet, schlagfest und bruchstabil, temperaturresistent von -10°C bis +100°C, säure-, laugen-, UV-beständig

Trapezoid Tray

melamine coated wood, dishwasher safe, walnut design, temperature resistant from -10°C to +100°C, resistant to food acids, alcohol and UV light, virtually unbreakable



Tablett, rund, rutschfest

aus glasfaserverstärktem Kunststoff, mit verstärktem Rand, bruchfest, spülmaschinengeeignet, temperaturresistent von -40°C bis +80°C, Oberfläche ist auch im nassen Zustand rutschfest

Round Tray, non slip

black fibreglass, with reinforced edge, dishwasher proof, virtually unbreakable, temperature resistant from -40°C to is +80°C



Art-Nr. Part No.	∅ dia.	Höhe Height	Farbe Colour
3775/351	35 cm	2,2 cm	schwarz/black
3775/401	40 cm	2,2 cm	schwarz/black

Tablett, rund, rutschfest

aus gummilaminierterm Schichtstoff, unzerbrechlich, spülmaschinengeeignet bis +100°C, kälterestistent bis -10°C, auch im nassen Zustand absolut rutschfest, säure-, laugen- und UV-beständig

Non Slip Round Tray

laminated with rubber lining, virtually unbreakable, dishwasher safe, temperature resistant from -10 ° to +100°C, resistant to food acids, alcohol and UV light



Art-Nr. Part No.	∅ dia. cm	Höhe Height cm	Farbe Colour
5305/321	32	1,5	schwarz/black
5305/381	38	1,5	schwarz/black
5305/387	38	1,5	braun/brown
5305/431	43	1,5	schwarz/black

Tablett, oval, rutschfest

aus gummilaminierterm Schichtstoff, unzerbrechlich, spülmaschinengeeignet bis +100°C, kälterestistent bis -10°C, auch im nassen Zustand absolut rutschfest, säure-, laugen und UV-beständig

Non Slip Oval Tray

laminated with rubber lining, virtually unbreakable, dishwasher safe, temperature resistant from -10 ° to +100°C, resistant to food acids, alcohol and UV light



Art-Nr. Part No.	Länge Length cm	Breite Width cm	Höhe Height cm	Farbe Colour
5308/261	26,5	20	1	schwarz/black

Bierglasträger, rutschfest

aus melaminbeschichtetem 3 mm starkem Pressholz, mahagonifarben, schlagfest und bruchstabil, temperaturresistent von -10°C bis +100°C, säure-, laugen-, UV-beständig

Beer Glass Tray, non slip

melamine coated wood, mahogany, temperature resistant from -10°C to +100°C, resistant to food acids, alcohol and UV light, virtually unbreakable



Art-Nr. Part No.	∅ dia.	Höhe Height	Farbe Colour
3502/330	33 cm	3,5 cm	mahagoni/mahogany
3502/360	36 cm	3,5 cm	mahagoni/mahogany

Die Tablett sind nur bedingt spülmaschinengeeignet.
Trays are not suitable for permanent dishwasher use.

Runde Tablett Serving Trays



contacto

Art-Nr. Part No.	∅ dia.	Höhe Height
3770/320	32 cm	2 cm
3770/360	36 cm	2 cm



Tablett, rund, rutschfest

aus braunem ABS-Kunststoff, hitzeresistent bis +80°C, spülmaschinengeeignet, sehr robuste, langlebige Spezialbeschichtung mit Korkanteil, temperaturbeständig bis ca. +150°C, alkohol- und fettresistent

Round Tray, non slip

brown ABS plastic, heat-resistant up to +80°C, dishwasher proof, cork surface, withstands heat up to +150°C, alcohol and fat-resistant



Art-Nr. Part No.	∅ dia.	Höhe Height
66/300	30 cm	2 cm
66/350	35 cm	2 cm
66/400	40 cm	2,2 cm
66/500	50 cm	2,2 cm



Serviertablett, rund

aus Edelstahl, hochglänzend, mit gebördeltem Rand

Round Service Tray

stainless steel, mirror polished finish, with rolled edge



Art-Nr. Part No.	∅ dia. cm	Höhe Height cm
6066/300	30	2,5
6066/350	36,5	2,5
6066/400	40	2,5



Tablett, rund

aus Edelstahl 18/0, hochglänzend, Bodenfläche mit Holografie-Effekt gebürstet, gebördelter Rand, schwere Qualität

Round Tray

18/0 stainless steel, mirror polished hammered finish, rolled edge, heavy gauge



Art-Nr. Part No.	∅ dia. cm	Höhe Height cm
52/410	41 cm	2,2 cm



Tablett, rund

aus Edelstahl 18/10, hochglänzend, mit gebördeltem Rand, schwere Qualität

Round Service Tray

18/10 stainless steel, mirror polished finish, with rolled edge, heavy gauge



Art-Nr. Part No.	∅ dia.	Höhe Height
---------------------	-----------	----------------

PRODUKTION
EINGESTELLT
PRODUCTION
DISCONTINUED



Tablett, rund

aus Edelstahl 18/0, hochglänzend, mit gebördeltem Rand, schwere Qualität

Round Tray

18/0 stainless steel, mirror polished finish, with rolled edge



Art-Nr. Part No.	Länge Length cm	Breite Width cm	Höhe Height cm
4647/210	21	13	1,5

Abgebildetes hohes Glas Art. 1270 siehe Seite 387.
Lemon tea/ Latte glass can be found on page 387.



Serviertablett, rechteckig

aus Edelstahl, matt poliert, gebördelter Rand

Rectangular Tray

stainless steel, matt polished, rolled edge



Serviertablett, oval

aus Edelstahl, hochglänzend, mit gebördeltem Rand

Oval Tray

stainless steel, mirror polished finish, with rolled edge



Art-Nr. Part No.	Länge Length cm	Breite Width cm	Höhe Height cm
65/195	20	14,5	1
65/230	23	17,5	1,1
65/265	26,5	19,5	1,2
65/290	28,5	22	1,4

Serviertablett, oval

aus Edelstahl, matt poliert, mit gebördeltem Rand

Oval Tray

stainless steel, matt polished finish, with rolled edge



Art-Nr. Part No.	Länge Length cm	Breite Width cm	Höhe Height cm
64/190	20	14,5	1
64/230	23	17,5	1,1
64/260	26,5	19,5	1,2
64/290	28,5	22	1,4

Serviertablett, rutschfest

aus melaminbeschichtetem 3 mm starkem Pressholz, mahagonifarben, spülmaschineneignend, säureresistent

Oval Tray, non slip

melamine coated wood, mahogany, resistant to food acids and alcohol, dishwasher proof



Art-Nr. Part No.	Länge Length cm	Breite Width cm	Höhe Height cm	Farbe Colour
3503/260	26	20	1,3	mahagoni/mahogany

Serviertablett, oval

aus melaminbeschichtetem 3 mm starkem Pressholz, mit Nussbaum-Dekor, spülmaschineneignend, schlagfest und bruchstabil, temperaturresistent von -10°C bis +100°C, säure-, laugen-, UV-beständig

Oval Tray

3 mm thick melamine coated wood, walnut design, dishwasher proof, temperature resistant from -10°C to +100°C, resistant to food acids, alcohol and UV light, virtually unbreakable



Art-Nr. Part No.	Länge Length cm	Breite Width cm	Höhe Height cm	Farbe Colour
3403/230	23	16	1,5	nussbaum/walnut
3403/260	26,5	20	1,5	nussbaum/walnut
3403/290	29	21	1,9	nussbaum/walnut

Serviertablett, oval

aus glasfaserverstärktem Polyester, schlagfest und bruchstabil, spülmaschineneignend, temperaturresistent von -50°C bis +140°C, säure-, laugen- und UV-beständig, im Stapel belüftbar

Oval Tray

fibreglass reinforced polyester, with drying/stacking lugs, dishwasher proof, temperature resistant from -50°C to +140°C, resistant to food acids, alcohol & UV light, virtually unbreakable



Art-Nr. Part No.	Länge Length cm	Breite Width cm	Höhe Height cm	Farbe Colour
---------------------	-----------------------	-----------------------	----------------------	-----------------

Nicht rutschfest:

5351/002 29 21 1,8 lichtgrau/light grey

Rutschfest: / Non-slip:

5351/901 29 21 1,8 schwarz/black



Art-Nr. Part No.	Höhe Height cm	∅ außen ∅ Outside cm	∅ innen ∅ Inside cm
865/300	1,5	30	20



Platzteller

aus Edelstahl, hochglänzend, mit geschlossener Umlaufkante

Service Plate

stainless steel, mirror polished finish, with closed edge



Art-Nr. Part No.	Höhe Height cm	∅ außen ∅ Outside cm	∅ innen ∅ Inside cm

PRODUKTION
EINGESTELLT
PRODUCTION
DISCONTINUED



Platzteller, rund

aus Edelstahl, hochglänzend, mit offener Umlaufkante

Service Plate

stainless steel, mirror polished finish, with open edge



Art-Nr. Part No.	Höhe Height cm	∅ außen ∅ Outside cm	∅ innen ∅ Inside cm
4457/300	0,8	30	19



Platzteller

mit Perlrund, aus versilbertem Stahl, Silberschicht 0,5 µ, anlaufgeschützt, nicht spülmaschinene geeignet, mit offen gebördeltem Rand

Service Plate

0.5 micron silverplated steel, varnished, with rolled pearl edge, not dishwasher safe



Art-Nr. Part No.	Höhe Height cm	∅ außen ∅ Outside cm	∅ innen ∅ Inside cm
232/120	0,8	12	6,5

Für Eiskelche 4680, 4682 auf Seite 281: / For Sundae Cups 4680, 4682 on page 281:

Art-Nr. Part No.	Höhe Height cm	∅ außen ∅ Outside cm	∅ innen ∅ Inside cm
232/140	1	14	8

Für Eiskelche 4685, 4672: / For Sundae Cups 4685, 4672:



Untersetzer

aus Edelstahl 18/10, hochglänzend, mit offenem Rand, schwere Qualität

Coaster

18/10 stainless steel, mirror polished finish, open edge, heavy gauge



Art-Nr. Part No.	∅ außen ∅ Outside cm
1415/090	9
1415/110	11
1415/140	14



Untersetzer

aus Edelstahl 18/10, hochglänzend, glatte Bodenfläche, als Tablett, Eiskelch- oder Flaschenuntersetzer geeignet

Tip Tray/ Coaster

18/10 stainless steel, mirror polished finish, plain base



Tellerglocke, weiß

aus Polypropylen, mit Griffloch, temperaturbeständig von -20°C bis +120°C, spülmaschinenfest, mikrowellengeeignet, stapelbar

Plate Cover, white

polypropylene, virtually unbreakable, dishwasher safe, can be used between -20°C and +120°C, usable in microwave ovens, with grip hole, stackable * Fits Wood & Sons® 9" NHS plate, Churchill® 9" Nova and Classic plate + Steelite® 9" Slimline plate, ** Fits Dudson® 9" NHS plate *** Fits on Churchill® 10" Classic + Nova plates



Art-Nr. Part No.	∅ Teller ∅ Plate	Höhe Height
6440/210	21 cm	6 cm
6440/220	22 cm	6 cm
6440/230*	23 cm	6 cm
6440/235**	23,5 cm	6 cm
6440/243	24,1 cm	6 cm
6440/253	25 cm	6 cm
6440/257***	25,7 cm	6 cm
6440/265	26,5 cm	6 cm
6440/270	27 cm	6 cm
6440/273	27,3 cm	6 cm
6440/280	28 cm	6 cm
6440/283	28,3 cm	6 cm
6440/290	29 cm	6 cm
6440/300	30 cm	6 cm
6440/310	31 cm	6 cm
6440/320	32 cm	6 cm

Tellerglocke, transparent-weiß

aus Polypropylen, mit Griffloch, temperaturbeständig von -20°C bis +120°C, spülmaschinenfest, mikrowellengeeignet, stapelbar

Plate Cover, translucent

polypropylene, virtually unbreakable, dishwasher safe, can be used between -20°C and +120°C, usable in microwave ovens, with grip hole, stackable * Fits Wood & Sons® 9" NHS plate, Churchill® 9" Nova and Classic plate + Steelite® 9" Slimline plate, ** Fits Dudson® 9" NHS plate *** Fits on Churchill® 10" Classic + Nova plates



Art-Nr. Part No.	∅ Teller ∅ Plate	Höhe Height
6441/210	21 cm	6 cm
6441/220	22 cm	6 cm
6441/230*	23 cm	6 cm
6441/235**	23,5 cm	6 cm
6441/243	24,1 cm	6 cm
6441/253	25 cm	6 cm
6441/257***	25,7 cm	6 cm
6441/265	26,5 cm	6 cm
6441/270	27 cm	6 cm
6441/273	27,3 cm	6 cm
6441/280	28 cm	6 cm
6441/283	28,3 cm	6 cm
6441/290	29 cm	6 cm
6441/300	30 cm	6 cm
6441/310	31 cm	6 cm
6441/320	32 cm	6 cm

Tellerglocke, gelb

aus Polypropylen, mit Griffloch, temperaturbeständig von -20°C bis +120°C, spülmaschinenfest, mikrowellengeeignet, stapelbar

Plate Cover, dark yellow

polypropylene, virtually unbreakable, dishwasher safe, can be used between -20°C and +120°C, usable in microwave ovens, with grip hole, stackable * Fits Wood & Sons® 9" NHS plate, Churchill® 9" Nova and Classic plate + Steelite® 9" Slimline plate, ** Fits Dudson® 9" NHS plate *** Fits on Churchill® 10" Classic + Nova plates



Art-Nr. Part No.	∅ Teller ∅ Plate	Höhe Height
6442/210	21 cm	6 cm
6442/220	22 cm	6 cm
6442/230*	23 cm	6 cm
6442/235**	23,5 cm	6 cm
6442/243	24,1 cm	6 cm
6442/253	25 cm	6 cm
6442/257***	25,7 cm	6 cm
6442/265	26,5 cm	6 cm
6442/270	27 cm	6 cm
6442/273	27,3 cm	6 cm
6442/280	28 cm	6 cm
6442/283	28,3 cm	6 cm
6442/290	29 cm	6 cm
6442/300	30 cm	6 cm
6442/310	31 cm	6 cm

Graue Tellerglocken auf Anfrage.
Light grey plate covers on request.

Tellerglocke, geschlossen

aus Polypropylen, mit Griffmulden, temperaturbeständig von -20°C bis +120°C, spülmaschinenfest, mikrowellengeeignet, stapelbar

Plate Cover

polypropylene, virtually unbreakable, with grip mould, dishwasher safe, can be used between -20°C and +120°C, usable in microwave ovens, stackable



Art-Nr. Part No.	∅ Teller ∅ Plate	Höhe Height	Farbe Colour
6446/253	25,3 cm	6 cm	weiß/white
6446/259	25,9 cm	6 cm	weiß/white
6446/270	27 cm	6 cm	weiß/white
6446/280	28 cm	6 cm	weiß/white
6447/253	25,3 cm	6 cm	transparent
6447/259	25,9 cm	6 cm	transparent
6447/270	27 cm	6 cm	transparent
6447/280	28 cm	6 cm	transparent

Tellerglocken

Plate Covers and Cloches



Art-Nr.	∅ Teller	Höhe
Part No.	∅ Plate	Height
6443/190	19 cm	8,5 cm
6443/200	20 cm	8,5 cm
6443/210	21 cm	8,5 cm



Tellerglocke, transparent-weiß

aus Polypropylen, ohne Griffloch, hohe Form, temperaturbeständig von -20°C bis +120°C, spülmaschinenfest, mikrowellengeeignet, stapelbar

Plate Cover, translucent

polypropylene, virtually unbreakable, high version, without grip hole, dishwasher safe, can be used between -20°C and +120°C, usable in microwave ovens, stackable



Art-Nr.	∅ Teller	Höhe
Part No.	∅ Plate	Height
6448/243	24,1 cm	5 cm



Tellerglocke mit Griff

aus Polypropylen, mit Griffmulden, temperaturbeständig von -20°C bis +120°C, spülmaschinenfest, mikrowellengeeignet, stapelbar

Plate Cover with Knob

polypropylene, virtually unbreakable, with grip mould, dishwasher safe, can be used between -20°C and +120°C, usable in microwave ovens, stackable



Art-Nr.	∅ Teller	Höhe
Part No.	∅ Plate	Height
6435/252	25,2 cm	6,5 cm
6435/300	30 cm	8,5 cm



Tellerglocke, klar, rund

aus glasklarem Polycarbonat, konische Form, mit Griffloch, temperaturbeständig von -30°C bis +125°C, nicht mikrowellengeeignet, spülmaschinenfest, stapelbar

Plate Cover

clear polycarbonate, with grip hole, can be used between -30°C and +120°C, not suitable for use in microwave ovens, dishwasher safe, stackable



Art-Nr.	Länge außen	Breite außen	Höhe
Part No.	Outer Length	Outer Width	Height
	cm	cm	cm
6449/260	26,5	20	6,5
6449/315	31,5	24	6,5
6449/360	36	28	7



Tellerglocke, klar, oval

aus glasklarem Polycarbonat, mit Griffloch, temperaturbeständig von -30°C bis +125°C, nicht mikrowellengeeignet, spülmaschinenfest, stapelbar

Oval Plate Cover

clear polycarbonate, with grip hole, can be used between -30°C and +120°C, not suitable for use in microwave ovens, dishwasher safe, stackable



Art-Nr.	∅ außen	Höhe
Part No.	∅ Outside	Height
	cm	cm
6498/200	20,5	5



Tellerglocke, rund

aus Aluminium, nicht spülmaschinengeeignet

Plate Cover

aluminium, rolled edge, not dishwasher safe



Art-Nr.	∅ oben	∅ außen	Höhe
Part No.	∅ Top	∅ Outside	Height
	cm	cm	cm
6497/200	16,7	20	4,6



Stapelring für Teller

aus Aluminium, nicht spülmaschinengeeignet

Plate Ring

aluminium, rolled edge, not dishwasher safe



Tellerglocke, rund

aus Edelstahl 18/10, hochglänzend, konische Form, stapelbar (auch mit Teller), mit gebördeltem Griffloch und Rand, schwere Qualität. Wir fertigen alle Größen von Tellerglocken nach Vorlage Ihres Porzellantellers. Preis auf Anfrage.

Plate Cover

18/10 stainless steel, mirror polished, with wrapped edges, stackable (with and without plates), heavy gauge. We can make virtually any size of cover on receipt of your plate. Prices on request.



Art-Nr. Part No.	∅ Teller ∅ Plate cm	Höhe Height cm
6480/212	19,1 - 20,5	4
6480/250	23,5 - 24,3	4,5
6480/264*	25,2 - 25,7	5,5
6480/266	25,2 - 25,8	4,5
6480/278	26,6 - 27,1	4,5
6480/285	26,5 - 27,8	5

6480/290	27 - 28,3	5
6480/316	29,2 - 30,7	5
6480/324	29,9 - 31,5	5

*Fits Churchill® 10" Nova + Classic plates.

Bitte berücksichtigen Sie die Toleranzen des Porzellanherstellers beim Ausmessen des Tellers.

Please take into account the china manufacturer's tolerances when measuring the external diameter of your plate.

Tellerglocke, rund

aus Edelstahl 18/10, matt geschliffen, konische Form, stapelbar (auch mit Teller), mit Steggriff und gerolltem Rand

Plate Cover

18/10 stainless steel, ground finish, with wrapped edges, with bar handle, stackable (with and without plates)



Art-Nr. Part No.	∅ Teller ∅ Plate cm	Höhe Height cm
6481/236	22,2 - 22,9	4,5
fits Wood & Sons 9" NHS + Steelite 9" Slimline plates		
6481/242	22,7 - 23,5	4,5
fits Dudson 9" NHS plate, Churchill 9" Classic + Nova plates		
6481/250	23,5 - 24,3	4,5
6481/266	25,3 - 25,8	4,5
6481/290	27 - 28,3	5
6481/316	29,2 - 30,7	5

Tellerglocke, rund

aus Edelstahl 18/10, hochglänzend, klassische Form, mit gebördeltem Griffloch und Rand, schwere Qualität. Wir fertigen alle Größen von Tellerglocken nach Vorlage Ihres Porzellantellers. Preis auf Anfrage.

Plate Cover

18/10 stainless steel, mirror polished, with wrapped edges, heavy gauge. We can make virtually any size of cover on receipt of your plate. Prices on request.



Art-Nr. Part No.	∅ Teller ∅ Plate cm	Höhe Height cm
6490/180	16,2 - 17,1	5
6490/217	19,9 - 21	5
6490/237*	22,2 - 23	5
6490/248	23 - 24,1	5
6490/254	23,6 - 24,6	5
6490/259	23,9 - 25	5
6490/263**	24,5 - 25,5	5,5
6490/266	25,3 - 25,8	5,5
6490/270	25,1 - 26,2	5,5
6490/274	26,1 - 26,7	5,5
6490/279	26,3 - 27,2	5,5
6490/283	26,2 - 27,5	5,5
6490/288	27 - 27,9	5
6490/291	27,5 - 28,3	5
6490/296	28,2 - 28,9	5
6490/310	29,5 - 30,2	5
6490/323	31 - 31,7	5
6490/330	31,2 - 32,2	5
6490/335	31,2 - 32,7	6

*Fits Wood & Sons® 9" NHS and Steelite® 9" Slimline plate.

** Fits Churchill® 10" Nova + Classic plates.

Bitte berücksichtigen Sie die Toleranzen des Porzellanherstellers beim Ausmessen des Tellers.

Please take into account the china manufacturer's tolerances when measuring the external diameter of your plate.



Art-Nr. Part No.	∅ innen ∅ Inside cm	Höhe gesamt Overall Height cm	∅ außen ∅ Outside cm
6880/200	20	14	21,2
6880/240	23,6	14	24,5
6880/260	26,2	15	26,8
6880/300	30,1	17	31,2



Speiseglocke

aus Edelstahl 18/10, hochglänzend mit Griffknopf, schwere Qualität

Cloche

18/10 stainless steel, mirror polished finish, with knob, heavy gauge



Art-Nr. Part No.	∅ innen ∅ Inside cm	Höhe gesamt Overall Height cm	∅ außen ∅ Outside cm
8880/240	23,6	14	24,5
8880/260	26,2	15	26,8
8880/300	30,1	17	31,2



Gold

Speiseglocke

aus Edelstahl 18/10, hochglänzend, wahlweise mit vergoldetem Griffknopf, schwere Qualität

Cloche

18/10 stainless steel, mirror polished finish, optional with gold plated knob, heavy gauge



Art-Nr. Part No.	∅ dia. cm	Höhe Height cm
6450/251	25	13,5



Speiseglocke

aus Edelstahl 18/10, hochglänzend, Auflagerand verstärkt

Cloche

18/10 stainless steel, mirror polished finish, reinforced edge



Art-Nr. Part No.	∅ dia. cm	Höhe Height cm
6450/250	25 cm	13,5 cm



Gold

Speiseglocke

aus Edelstahl, mit goldfarbenem Griffknopf, Auflagerand verstärkt

Cloche

stainless steel, mirror polished finish, with gold coloured knob, reinforced edge





contacto

Körbe Natur

Back to nature. Die Körbe aus Vollweide sind wunderbar als Tisch- und Buffetkorb geeignet und präsentieren Brot, Obst und andere Speisen auf attraktiv natürliche Weise.

Willow Baskets

Add a touch of authenticity with **contacto's** natural willow baskets. Perfectly suited for display and service of bread and rolls.

Brötchenschütte/Regalkorb

aus dunkler, gesottener Vollweide, Höhe innen hinten: 22 cm, Höhe innen vorne: 12 cm, hochwertige Qualität

Bread/Display Basket

dark willow, inner height at rear: 22 cm, inner height at front: 12 cm, heavy gauge



Art-Nr. Part No.	Breite außen Outer Width cm	Länge außen Outer Length cm
4880/450	45	45

Brötchenschütte

aus dunkler, gesottener Vollweide, Höhe innen hinten: 10 cm, Höhe innen vorne: 5 cm, hochwertige Qualität, besonders geeignet für die Selbstbedienung

Bread Basket

dark willow, inner height at rear: 10 cm, inner height at front: 5 cm, heavy gauge, ideal for self service



Art-Nr. Part No.	Breite außen Outer Width cm	Länge außen Outer Length cm
4876/500	40	50

Auslage-/Buffetkorb

aus dunkler, gesottener Vollweide, hochwertige Qualität

Display/Buffer Basket

dark willow, high quality



Art-Nr. Part No.	Länge außen Outer Length cm	Breite außen Outer Width cm	Höhe außen Outer Height cm
4881/350	35	35	10

Korb, rechteckig

aus naturheller Vollweide

Bread Basket

light willow



Art-Nr. Part No.	Länge außen Outer Length cm	Breite außen Outer Width cm	Höhe außen Outer Height cm

PRODUKTION
INGESTELLT
PRODUCTION
DISCONTINUED

Art-Nr. Part No.	Breite außen Outer Width cm	Tiefe Depth cm	Höhe gesamt Overall Height cm
4882/500	50	27	61



Baguettekorb

aus dunkler, gesottener Vollweide, auch zum Aufhängen geeignet, hochwertige Qualität

Baguette Basket

dark willow, also suitable for wall mounting, high quality



Art-Nr. Part No.	∅ außen ∅ Outside cm	Höhe Height cm
4873/003	48 / 36 / 26	57



Korb-Etagere

aus dunkler, gesottener Vollweide, hochwertige Qualität

3 Tier Stand

dark willow, high quality



Art-Nr. Part No.	∅ dia. cm	Höhe Height cm
4878/260	26	17



Eierkorb

aus dunkler, gesottener Vollweide, innen gepolstert mit Synthetikstoff

Egg Basket

dark willow, inside padded with synthetic fabric



Art-Nr. Part No.	Länge außen Outer Length cm	Breite außen Outer Width cm	Höhe außen Outer Height cm
4867/350	35	26	10 / 16
4867/400	40	32	12 / 18
4867/480	48	38	15 / 22

Lieferung ohne abgebildeten Inhalt.
Supplied without gifts shown.



Präsentkorb

aus naturheller Vollweide

Gift Basket

light willow



Art-Nr. Part No.	Länge außen Outer Length cm	Breite außen Outer Width cm	Höhe außen Outer Height cm
4868/340	34	28	16
4868/420	42	36	20

Lieferung ohne abgebildeten Inhalt.
Supplied without gifts shown.



Präsentkorb

aus naturheller Vollweide

Gift Basket

light willow



Gärschale

aus natürlichem Peddigrohr, atmungsaktiv, biologisch abbaubar, lebensmittelecht, ideal geeignet zum Gären des Teigs ohne Gärschrank, nicht zum Backen geeignet

Banneton

from natural rattan, natural respiration, bio-degradable, food safe, for naturally allowing dough to prove in the shape of the basket before its final bake, not suitable for use in ovens



Art-Nr. Part No.	Länge innen Inner Length cm	Breite innen Inner Width cm	Höhe innen Inner Height cm
für 0,5 kg Stangenbrot: / for 0.5 kg baguette:			
4859/450	42,5	8,5	5,5
für 0,5 kg rundes Brot: / for 0.5 kg round bread:			
4857/200	18,5		7
für 1 kg rundes Brot: / for 1 kg round bread:			
4857/220	20,5		7,5
für 0,5 kg ovales Brot: / for 0.5 kg oval bread:			
4858/300	28	12	5,5

Korb, bauchig

aus Bambus in Rattanschiene, stabile Ausführung, feucht abwischbar

Round Basket

bamboo and rattan, robust, can be wiped with wet cloth



Art-Nr. Part No.	∅ außen ∅ Outside cm	∅ oben ∅ Top cm	Höhe Height cm
4861/250	25	22	8
4861/345	34,5	29,5	10,5

Servierkorb, oval

aus dunkler, gesottener Vollweide, hochwertige Verarbeitung

Serving Basket

dark willow, high quality



Art-Nr. Part No.	Länge außen Outer Length cm	Breite außen Outer Width cm	Höhe außen Outer Height cm
4889/290	29	20	7

Besteckkorb, tief

aus naturheller Vollweide, mit Holzboden

Deep Cutlery Basket

light willow, wooden base



Art-Nr. Part No.	Länge Length cm	Breite Width cm	Höhe Height cm
4890/250	25	15	15

Brotkorb, rund

aus naturheller Vollweide, hochwertige Verarbeitung

Round Basket

light willow, high quality



Art-Nr. Part No.	∅ außen ∅ Outside cm	Höhe außen Outer Height cm
4886/220	20	8

Brotkorb, rund

aus naturhellem Bambus

Round Bread Basket

light bamboo



Art-Nr. Part No.	∅ außen ∅ Outside cm	Höhe außen Outer Height cm
4884/200	20	6
4884/220	22	7
4884/250	25	7

Brotkorb, oval

aus naturhellem Bambus

Oval Bread Basket

light bamboo



Art-Nr. Part No.	Länge außen Outer Length cm	Breite außen Outer Width cm	Höhe außen Outer Height cm
4885/160	16	12	6
4885/200	20	15,5	7
4885/230	23	18	7
4885/250	25	21	7

Körbe Edelstahl

In den luftigen Körben aus Edelstahl 18/10 bewahren Sie stilvoll Obst, Gemüse und anderes Frisches auf. Nützlich in der Küche und ein toller Blickfang auf dem Tisch.

Stainless Steel Baskets

These wire baskets are perfect for holding fruit at buffets and for room service.

Art-Nr. Part No.	Ø dia.	Höhe Height
2070/170	17 cm	7,5 cm
2070/200	20,5 cm	9 cm
2070/240	24,5 cm	10 cm



Brot-/ Obstkorb, rund
aus Edelstahl, hochglänzend,
oberer Abschluss mit Flachband

Round Bread/Fruit Basket
stainless steel, mirror polished finish, flat top



Art-Nr. Part No.	Ø dia.	Höhe Height
2071/170	17 cm	6 cm
2074/245	25 cm	8,5 cm



Brot-/ Obstkorb, rund
aus Edelstahl 18/10, hochglänzend,
hochwertige Ausführung, oberer Abschluss
mit Runddraht, schwere Qualität

Bread/Fruit Basket - round
18/10 stainless steel, mirror polished finish,
wire top, heavy gauge



Art-Nr. Part No.	Größe Size	Höhe Height
2072/200	20 x 15 cm	6 cm
2072/290	29 x 19 cm	8,5 cm



Brot-/ Obstkorb, oval
aus Edelstahl 18/10, hochglänzend,
hochwertige Ausführung, oberer Abschluss
mit Runddraht, schwere Qualität

Oval Bread/Fruit Basket
18/10 stainless steel, mirror polished finish,
wire top, heavy gauge



Art-Nr. Part No.	Ø dia.	Höhe Height
2073/180	18 cm	6 cm



Brot-/ Obstkorb
Blütenform, aus Edelstahl 18/10, hochglänzend,
hochwertige Ausführung, oberer Abschluss
mit Runddraht, schwere Qualität

Bread/Fruit Basket
18/10 stainless steel, mirror polished finish,
wire top, heavy gauge



Brot-/ Obstkorb, rund

aus Edelstahl 18/10, hochglänzend, hochwertige Ausführung, oberer Abschluss mit Runddraht, schwere Qualität

Bread/Fruit Basket

18/10 stainless steel, mirror polished finish, wire top, heavy gauge



Art-Nr. Part No.	∅ dia.	Höhe Height
2076/130	24,5 cm	13 cm

Früchtekorb, rund

weitmaschig, aus Edelstahl 18/10, hochglänzend, hochwertige Ausführung, oberer Abschluss mit Runddraht, schwere Qualität

Bread/Fruit Basket

18/10 stainless steel, mirror polished finish, wire top, heavy gauge



Art-Nr. Part No.	∅ dia.	Höhe Height
2077/200	21,5 cm	20 cm

Früchtekorb

aus 5 bzw. 2 mm starkem Edelstahldraht 18/10, beidseitig verwendbar, hochwertige Verarbeitung

Fruit Basket

5 and 2 mm thick 18/10 stainless steel wire, can be used either way up, high quality



Art-Nr. Part No.	∅ außen ∅ Outside cm	∅ innen ∅ Inside cm	Höhe Height cm

PRODUKTION
EINGESTELLT
PRODUCTION
DISCONTINUED

Grissini-Korb

aus Edelstahl 18/10, hochglänzend, leicht konische Form, stabile, schwere Qualität

Bread Stick Basket

18/10 stainless steel, mirror polished finish, conical shape, stable, heavy gauge



Art-Nr. Part No.	∅ oben ∅ Top cm	∅ Boden ∅ Base cm	Höhe Height cm
2079/090	9	9	13

Korb, oval

aus versilbertem Stahldraht, Silberschicht 0,5 µ, anlaufgeschützt, nicht spülmaschinengeeignet

Oval Bread Basket

0.5 micron silverplated steel, lacquered, not dishwasher safe



Art-Nr. Part No.	Länge innen Inner Length cm	Breite innen Inner Width cm	Höhe Height cm
4402/230	20	14	6
4402/270	25,5	16,5	5



Art-Nr. Part No.	∅ oben ∅ Top cm	∅ unten ∅ Base cm	Höhe Height cm
2285/210	21	18	7

Lieferung mit weißem Damasttuch ganz aus Baumwolle.
Includes white 100% cotton napkin.



Brötchenkorb, rund

aus verchromtem 5 mm starkem Stahldraht, Stoff- oder Papierservietten lassen sich einfach zwischen die beiden Gestelle einlegen und spannen den Korb aus, Servietten mit dem eigenen Logo geben eine individuelle Note

Wire Basket

5 mm thick chrome plated wire, napkins can be fitted between the two frames



Art-Nr. Part No.	Länge Length cm	Breite Width cm	Höhe Height cm
1260/310	30,5	16,5	5



Brotschale, oval

aus Edelstahl 18/10, hochglänzend, schwere Qualität

Oval Bread Basket

18/10 stainless steel, mirror polished finish, heavy gauge



Art-Nr. Part No.	Länge außen Outer Length cm	Breite außen Outer Width cm	Höhe Height cm
1230/265	26,5	18,5	4
1230/310	31	22	4,5



Brotschale, oval

aus Edelstahl 18/0, hochglänzend, mit offen gebördeltem Rand

Bread Basket

18/0 stainless steel, mirror polished finish, with open rolled edge



Art-Nr. Part No.	Länge Length cm	Breite Width cm	Höhe Height cm
---------------------	-----------------------	-----------------------	----------------------

Für 4 Scheiben: / For 4 slices:

7676/004	5	12,5	6
----------	---	------	---

Für 6 Scheiben: / For 6 slices:

7676/006	5	14	5
----------	---	----	---



Toastständer

aus Edelstahl 18/10, hochglänzend, für maximale Toastdicke ca. 14 mm

Toast Rack

18/10 stainless steel, mirror polished finish, for 14 mm slices



Art-Nr. Part No.	Tiefe Depth cm	Breite Width cm	Höhe Height cm
---------------------	----------------------	-----------------------	----------------------

Für 4 Scheiben: / For 4 slices:

34/004	8	14	8
--------	---	----	---

Für 6 Scheiben: / For 6 slices:

34/006	8	19,5	8
--------	---	------	---



Toastständer

aus Edelstahl 18/10, hochglänzend, für max. Toastdicke etwa 11 mm

Toast Rack

18/10 stainless steel, mirror polished finish, for 11 mm slices





Körbe Polypropylen

Die Optik und Haptik der Körbe aus Polypropylen gleichen nahezu dem Naturprodukt aus Vollweide, lassen sich aber in der Spülmaschine waschen und halten bedeutend länger.

Polypropylene Baskets

The appearance and feel of these baskets is almost identical to that of natural willow, but they can be cleaned in the dishwasher and last considerably longer.

Die Körbe sind komplett aus starkem Polypropylen garn gefertigt. Das Material ist farbbeständig, hygienisch, lebensmittelecht, bruchsicher und für die Spülmaschine geeignet. Die schwere Ausführung spricht für seine Qualität. Das Garn hat eine spezielle Oberflächenstruktur die dem natürlichen Material sehr nahe kommt.

These baskets are completely made of polypropylene rattan. The material is colour-fast, hygienic, food safe, robust and suitable for the dishwasher. The heavy construction indicates quality. The weave has a special surface that immitates natural material very closely.



- lebensmittel geeignetes PP
- lange Lebensdauer
- spülmaschinengeeignet
- gute Optik/Haptik
- in 3 Farben verfügbar
- *food safe polypropylene*
- *durable*
- *dishwasher safe*
- *nice apperance and feel*
- *three coulours available*

Korb GN

GN Basket



Art-Nr. Part No.	GN	Höhe außen Outer Height cm	Farbe Colour
4781/011	1/1	10	natur/natural
4781/012	1/2	10	natur/natural
4781/013	1/3	10	natur/natural
4781/014	1/4	10	natur/natural
4781/016	1/6	10	natur/natural
4781/023	2/3	10	natur/natural

Korb, rechteckig

naturfarben

Basket, rectangular

natural colour



Art-Nr. Part No.	Länge Length cm	Breite Width cm	Höhe außen Outer Height cm
Halbes Bäckermaß:			
4781/400	40	30	9

Korb, rechteckig, flach

Shallow Rectangular Basket



Art-Nr. Part No.	Länge Length cm	Breite Width cm	Höhe Height cm
4786/300	30	20	4

Polypropylen-Körbe

Polypropylene Baskets

Art-Nr. Part No.	Länge außen Outer Length cm	Breite außen Outer Width cm	Höhe Height cm	Farbe Colour
4785/230	23	18,5	8	natur/natural
4785/233	23	18,5	8	braun/brown
4785/237	23	18,5	8	schwarz/black



Korb, rechteckig
Rectangular Basket

Art-Nr. Part No.	Länge Length cm	Breite Width cm	Höhe Height cm	Farbe Colour
4787/240	24	15	7	natur/natural
4787/243	24	15	7	braun/brown
4787/247	24	15	7	schwarz/black



Korb, oval
Oval Basket

Art-Nr. Part No.	∅ außen ∅ Outside cm	Höhe Height cm	Farbe Colour
4783/170	17	5	natur/natural
4783/173	17	5	braun/brown
4783/177	17	5	schwarz/black
4783/210	20	6,5	natur/natural
4783/213	20	6,5	braun/brown
4783/217	20	6,5	schwarz/black
4783/250	25	9,5	natur/natural
4783/253	25	9,5	braun/brown
4783/257	25	9,5	schwarz/black



Korb, rund
Round Basket

Art-Nr. Part No.	Maß Size cm	Höhe Height cm
4789/380	38	8,5



Korb, rund
Round Basket

Art-Nr. Part No.	Länge außen Outer Length cm	Breite außen Outer Width cm	Höhe Height cm	Farbe Colour
4788/275	28	12	7	natur/natural
4788/273	28	12	7	braun/brown
4788/277	28	12	7	schwarz/black



Besteckkorb
Cutlery Basket

Art-Nr. Part No.	∅ dia. cm	Höhe Height cm	Farbe Colour
4784/150	12	15	natur/natural
4784/153	12	15	braun/brown
4784/157	12	15	schwarz/black



Besteckkorb, hoch
Cutlery Basket

Hot Dog Ablage

aus Edelstahl 18/10, hochglänzend,
zur Ablage von zwei Hot Dogs oder Baguettes

Hot Dog Stand

18/10 stainless steel, mirror polished finish,
suitable for two hot dogs or baguettes

18/10
EDELSTAHL
STAINLESS STEEL



Art-Nr. Part No.	Länge Length cm	Breite Width cm	Höhe Height cm	Anzahl Fächer Slots
5670/002	24,5	13	3,5	2

Snackablage (Snackwelle)

aus Edelstahl, matt, zum Ablegen von Brötchen,
Döner sowie der Präsentation von Snacks

Roll/ Sandwich Stand

stainless steel, matt polished

INOX
EDELSTAHL
STAINLESS STEEL



Art-Nr. Part No.	Länge Length cm	Breite Width cm	Höhe Height cm	Anzahl Fächer Slots
5671/003	33	8	5,5	3
5671/005	57	8	5,5	5

Snackablage (Snackwelle)

aus mattem schwarzem Polystyrol, strukturierte
Oberfläche, auch passend in 60x40 Ablagesysteme
(Bäckermaß), Wellenbreite 150 mm, mittige Aussparung
zum Greifen der abgelegten Ware, Krümelrinne am Rand,
stabile Qualität

Roll / Sandwich Stand

matt black polystyrene, designed for easy service,
includes groove for collecting crumbs, heavy gauge

PS
POLYSTYRENE



Art-Nr. Part No.	Länge Length cm	Breite Width cm	Höhe Height cm	Anzahl Fächer Slots
4909/006	59	19,5	5,5	6

Snackablage (Snackwelle)

aus Acryl, zum Ablegen von Brötchen

Roll / Sandwich Stand

acrylic

ACRYL
ACRYLIC



Art-Nr. Part No.	Länge Length cm	Breite Width cm	Höhe Height cm	Anzahl Fächer Slots
6776/004	36	8,5	7	4

Verkaufsschütte

Rahmen aus Edelstahl, 3 Schütten mit je 1 Liter Volumen
aus gefrostedem Polystyrol

Buffet Display Stand

stainless steel frame, three 1 L polystyrene bowls

INOX
EDELSTAHL
STAINLESS STEEL

PS
POLYSTYRENE



Art-Nr. Part No.	Breite Width cm	Tiefe Depth cm	Höhe Height cm
6778/260	16	20	40
6778/902	Ersatzschale / Spare insert		

Tischaccessoires

An einer schön eingedeckten Tafel fühlt sich der Gast willkommen. Accessoires wie Serviettenhalter und -ringe, Kerzenhalter bieten sich an. Hilfsmittel finden sich auch für das Servicepersonal.

Front of House Accessories

Welcome guests to a beautifully set table. Accessories from **contacto** such as napkin holders, rings and candlesticks, as well as items for waiters capture the essence of hospitality.

Art-Nr. Part No.	Länge Length cm	Breite Width cm	Höhe Height cm
428/180	18	4,5	12,5

18/10
EDELSTAHL
STAINLESS STEEL



Serviettenhalter

aus Edelstahl 18/10, seidenmatt poliert, besonders standfest, schwere Qualität

Napkin/Serviette Holder

18/10 stainless steel, satin polished finish, very stable, heavy gauge

Art-Nr. Part No.	Länge Length cm	Breite Width cm	Höhe Height cm
425/120	12 cm	8 cm	7,5

18/10
EDELSTAHL
STAINLESS STEEL



Serviettenhalter

aus Edelstahl 18/10, hochglänzend

Napkin/Serviette Holder

18/10 stainless steel, mirror polished finish

Art-Nr. Part No.	Länge Length cm	Breite Width cm	Höhe Height cm
2284/140	14	3	6,5
2284/165	16,5	3	8

INOX
EDELSTAHL
STAINLESS STEEL



Serviettenhalter

aus Edelstahl, hochglänzend poliert

Napkin/Serviette Holder

stainless steel, mirror polished finish

Art-Nr. Part No.	Länge Length cm	Breite Width cm	Höhe Height cm
446/130	11,5 cm	3 cm	7

18/10
EDELSTAHL
STAINLESS STEEL



Serviettenhalter

aus Edelstahl 18/10, hochglänzend

Napkin/Serviette Holder

18/10 stainless steel, mirror polished finish

Art-Nr. Part No.	Länge Length cm	Breite Width cm	Höhe Height cm
---------------------	-----------------------	-----------------------	----------------------

für Cocktailservietten 25 x 25 cm (1/4 Falz): / for beverage napkins 10" x 10" (folded into 1/4):

429/125	12,5	12,5	9
---------	------	------	---

für Servietten 33 x 33 cm (1/4 Falz): / for luncheon napkins 13" x 13" (folded into 1/4):

429/165	16,5	16,5	9
---------	------	------	---

INOX
EDELSTAHL
STAINLESS STEEL



Serviettenhalter

aus Edelstahl, hochglänzend, mit Gummifüßchen

Napkin/Serviette Holder

stainless steel, mirror polished finish, with rubber feet

Serviettenhalter

aus zweifach verchromtem 5 mm starkem Draht,
hochglänzend, auf Kunststofffüßchen

Napkin Holder

5 mm double chrome plated wire, mirror finish,
plastic feet



Art-Nr. Part No.	Länge Length cm	Breite Width cm	Höhe Height cm
2240/200	20	11	20
für Servietten von 33 x 33 cm bis 36 x 36 cm (1/8 Falz) suitable for dinner napkins 13" x 13" folded into 1/8			
2240/240	24	13	24
für Servietten und Gästetücher von 40 x 40 cm bis 44 x 44 cm (1/8 Falz) suitable for dinner napkins 13" x 17" folded into 1/6 (= 4¼" x 8½") or 17" x 17" folded into 1/8 (= 4¼" x 8½") or guest towels 12" x 17" folded into 1/6			

Serviettenhalter

quadratisch, aus zweifach verchromtem 5 mm starkem
Draht, hochglänzend

Square Napkin Holder

5 mm double chrome plated wire, mirror finish

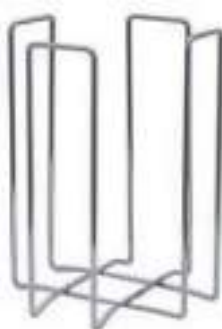

Art-Nr. Part No.	Länge Length cm	Breite Width cm	Höhe Height cm
2280/140	14	14	20
für Cocktailservietten 24 x 24 cm bis 25,5 x 25,5 cm (1/4 Falz) for beverage paper napkins 10" x 10" folded into 1/4			
2280/180	18	18	24
für Serviettengröße 33 x 33 cm (1/4 Falz) for luncheon paper napkins 13" x 13" folded into 1/4			

Serviettenhalter

dreieckig, aus zweifach verchromtem 5 mm starkem
Draht, hochglänzend, auf Kunststofffüßchen

Triangular Napkin Holder

5 mm double chrome plated wire, mirror finish,
plastic feet



Art-Nr. Part No.	Länge Length cm	Höhe Height cm
2290/280	20	24,5
für Serviettengröße 33 x 33 cm auf Dreieck gefaltet suitable for paper napkins 13" x 13" folded into a triangle		

Serviettenhalter

aus 6 mm starkem verchromtem Stahldraht
mit 8 mm starkem schwerem Niederhalter

Napkin Holder

chrome plated 6 mm steel wire frame,
8 mm strong hold-down wire



Art-Nr. Part No.	Länge Length cm	Breite Width cm	Höhe Height cm
2283/330	20	11,5	12
für Servietten 33 x 33 cm (1/4 Falz) for 33 x 33 cm (folded into 1/4) napkins			

Serviettenhalter

aus 5 mm starkem verchromtem Stahldraht,
ideal auf dem Tisch bei Indoor-Events

Napkin Holder

5 mm chrome plated steel wire



Art-Nr. Part No.	Länge innen Inner Length cm	Breite innen Inner Width cm	Höhe Height cm
2292/250	12,5	12,5	5,5
für Cocktail-Servietten 25,5 x 25,5 cm auf 1/4 gefalzt for 25.5 x 25.5 cm cocktail napkins folded into 1/4			

Serviettenhalter

Napkin/Serviette Holders



Art-Nr. Part No.	Breite Width cm	Tiefe Depth cm	Höhe Height cm
2282/190	10	12	19

nur für Spenderservietten 33 x 33 cm (1/8 Falz):
only for dispenser napkins 33 x 33 cm (folded into 1/8):



Serviettenspender

aus Edelstahl 18/0, hochglänzend poliert,
mit vier schwarzen Gummifüßchen,
mit Federmechanismus, beidseitig entnehmbar

Napkin Dispenser

18/0 stainless steel, mirror polished finish,
with 4 black rubber feet, both sided spring mechanism,
for folded paper napkins



Art-Nr. Part No.	∅ dia. cm	Breite Width cm
4452/004	4 cm	2,5 cm

Preis und Verpackung à 4 Stück.
Packed/priced in 4's.



Serviettenringe, rund

Set à 4 Stück, aus versilbertem Messing, Silberschicht
0,5 µ, anlaufgeschützt, nicht spülmaschinengeeignet

Round Napkin Rings (set of 4)

0.5 micron silverplated brass, varnished



Art-Nr. Part No.	Maß Size cm	Breite Width cm
4456/004	5 x 3	2,5

Preis und Verpackung à 4 Stück.
Packed/priced in 4's.



Serviettenringe, oval

Set à 4 Stück, aus versilbertem Messing, Silberschicht
0,5 µ, anlaufgeschützt, nicht spülmaschinengeeignet

Oval Napkin Rings

set of 4, 0.5 micron silverplated brass, varnished



Art-Nr. Part No.	Größe Size cm
2299/001	5 x 4 x 4



Serviettenring

aus Edelstahl, hochglänzend, dezent zeitlose Form

Napkin Ring

stainless steel, mirror polished finish



Art-Nr. Part No.	∅ dia. cm	Breite Width cm
2293/035	3,5	3



Serviettenring

aus Edelstahl, matt poliert

Napkin Ring

stainless steel, matt polished



Tischtuchklammern

aus Edelstahl 18/0, hochglänzend, fugenlos,
für max. 3 cm Tischstärke

Table Cloth Clips (set of 4)

18/0 stainless steel, mirror polished finish,
one piece, for tables up to 3 cm thick

18/0
EDELSTAHL
STAINLESS STEEL



Art-Nr. Part No.	Länge Length	Höhe Height
316/004	5 cm	4,5 cm

Preis und Verpackung à 4 Stück.
Priced and packed in 4's.

Tischtuchklammern

aus 1 mm starkem Edelstahl 18/10, hochglänzend,
für max. 3 cm Tischstärke, hochwertige Ausführung

Table Cloth Clips

1 mm thick 18/10 stainless steel, mirror polished finish,
for tables up to 3 cm thick

18/10
EDELSTAHL
STAINLESS STEEL



Art-Nr. Part No.	Länge Length	Höhe Height
304/004	5 cm	4,5 cm

Preis und Verpackung à 4 Stück.
Packed/priced in 4's.

Skirtingklammer

aus Edelstahl 18/0, mit Klettband, zur Befestigung von
Stoffen, um Möbel seitlich zu verkleiden

Table Skirting Clip

18/0 stainless steel, with Velcro®, for fastening cloth to
cover furniture sides

18/0
EDELSTAHL
STAINLESS STEEL



Art-Nr. Part No.	Länge Length	Höhe Height	Fläche Size
302/050	7 cm	4,5 cm	5 x 2,5 cm

Taschenhalter

aus verchromtem 5 mm starkem Stahldraht,
zum Aufhängen von zwei Handtaschen unter einem
Tisch oder einer Theke

Handbag Holder

5 mm chrome plated wire,
to hold two handbags under a table or counter

FE
EISEN
IRON

CHROMI
VERCHROMT
CHROME PLATE



Art-Nr. Part No.	Ø dia.
2295/100	10 cm

Taschenhalter

aus Edelstahl 18/10, mit beweglichem Haken,
zum Aufhängen einer Handtasche an einem Tisch oder
an einer Theke

Handbag Holder

18/10 stainless steel, movable handle,
for hanging a handbag under a table or counter

18/10
EDELSTAHL
STAINLESS STEEL



Art-Nr. Part No.	Breite Width	Höhe Height
2288/120	5 cm	12 cm



Art-Nr. Part No.	Höhe Height cm	∅ Fuß ∅ Foot cm	∅ oben ∅ Top cm
1046/185	18,5	6,5	2



Blumenvase

aus Edelstahl 18/10, hochglänzend, schwere Qualität, für frische Blumen geeignet

Bud Vase

18/10 stainless steel, mirror polished finish, heavy gauge, suitable for fresh flowers



Art-Nr. Part No.	Höhe Height cm	∅ Fuß ∅ Foot cm	∅ oben ∅ Top cm
1057/125	12,5	8,5	2,2
1057/180	18,5	8,5	2,2



Blumenvase/Kerzenhalter

aus Edelstahl 18/10, hochglänzend, schwere Qualität, geeignet für frische Blumen

Bud Vase/Candlestick

18/10 stainless steel, mirror polished, heavy gauge, suitable for fresh flowers



Art-Nr. Part No.	Höhe Height cm	∅ Fuß ∅ Foot cm	∅ Glas max. ∅ Glass max. cm
1078/285	28,5	10	5



Kerzenhalter auf Fuß

für Teelichte, hoher Fuß aus Edelstahl, matt poliert, das satinierte Glas ist leicht abnehmbar und durch eine Feder gesichert

Tealight / Candle Holder

stainless steel, satin polished, frosted glass



Art-Nr. Part No.	Höhe gesamt Overall Height cm	∅ dia. cm
1077/155	15,5	5



Kerzenhalter/ Windlicht

für Teelichte, Fuß aus Edelstahl, matt poliert, Glas satiniert

Tealight / Candle Holder

stainless steel, matt polished, frosted glass, for night / tea light candles



Art-Nr. Part No.	Höhe Height cm	∅ Glas max. ∅ Glass max. cm

PRODUKTION
EINGESTELLT
PRODUCTION
DISCONTINUED



Kerzenhalter/ Windlicht

pendelnde Aufhängung, schwarz beschichteter Stahl Draht, Teelicht wird in Glasschale eingesetzt

Tealight/ Candle Holder

for tea lights, swinging frame, with glass insert



Art-Nr. Part No.	∅ min. cm	Höhe Height cm	VPE carton qty
2704/030	6	13	340 ml 12
2704/060	6	21	600 ml 12
2704/100	8	21	1062 ml 6
2704/160	10	20,5	1590 ml 4



Weck® Stangenglas

mit Glasdeckel

Cylindrical Weck® Glass Jar

traditional German 'Weck®' glass, with glass lid



Preis je Verpackungseinheit. Ersatzdeckel auf Anfrage.
Priced per carton quantity. Spare lids on request.

Kerzenleuchter

aus Messing, hochglänzend poliert, mit Griff

Candle Holder

brass, mirror polished finish, with handle



Art-Nr. Part No.	∅ Fuß ∅ Foot cm	Höhe Height cm
3910/075	9	7,5

Kandelaber, übergroß

fünfarmig, aus glänzend gebürstetem Aluminiumguss, für handelsübliche Kerzen mit 22 mm Fußdurchmesser

Candelabra, 5 arm

extra large, mirror brushed cast aluminium, for 22 mm dia. candles



Art-Nr. Part No.	Höhe Height cm	∅ Fuß ∅ Foot cm	Länge Arm Arm Length cm
4440/060	60	16	38
4440/080	80	22	40
4440/100	100	22	40
4440/150	150	32	60

Leicht montierbar.

Supplied flat packed. Easy to assemble.

Kandelaber, dreiarmlig

aus versilbertem Zinkguss, Bodenfläche mit tischschonendem Velours belegt, Unterteil durch einfaches Stecksystem abtrennbar und somit auch als einfacher Kerzenständer nutzbar

Candelabra, 3 arm

0.5 micron silverplated zinc alloy, varnished, bottom surface covered with velour to protect table surface, can be dismantled and used as a single candlestick



Art-Nr. Part No.	∅ Fuß ∅ Foot cm	Höhe Height cm	Breite Width cm
4421/003	11,5	32,5	29

Kandelaber, fünfarmig

aus versilbertem Zinkguss, Bodenfläche mit tischschonendem Velours belegt, Unterteil durch einfaches Stecksystem abtrennbar und somit auch als einfacher Kerzenständer nutzbar

Candelabra, 5 arm

0.5 micron silverplated zinc alloy, varnished, bottom surface covered with velour to protect table surface, can be dismantled and used as a single candlestick



Art-Nr. Part No.	∅ Fuß ∅ Foot cm	Höhe Height cm	Breite Width cm
4421/005	11,5	32,5	29

Kerzenlöscher

aus Edelstahl 18/10, hochglänzend

Candle Snuffer

18/10 stainless steel, mirror polished finish



Art-Nr. Part No.	Länge Length cm	∅ dia. cm
1058/210	21 cm	3 cm

Art-Nr. Part No.	Länge Length cm	Breite Width cm
Schwarz: / Black:		
6551/051	50	90
6551/081	80	90
Weiß: / White:		
6551/054	50	90
6551/084	80	90



Bistro-Schürze / Vorbinder

aus 100% Baumwolle (Körper), Gewicht 210 GSM (g/m²), Bänder 2,5 cm breit und ca. 50 cm lang, waschbar bis +90°C (weiß) bzw. +60°C (schwarz)

Bistro Apron

100% cotton twill, 210 gsm, with approx. 50 x 2.5 cm sewn in ties, washable up to +90°C (white) and +60°C (black)



Art-Nr. Part No.	Länge Length cm	Breite Width cm
6552/104	100	100



Bistro-Schürze / Vorbinder

weiß, aus 100% Baumwolle (Körper), mit Taschen-schlitzten, Gewicht 250 GSM (g/m²), Bänder 2 cm breit und ca. 80 cm lang, waschbar bis +90°C

Bistro Apron

white, 100% cotton twill, 250 gsm, with approx. 80 x 2 cm sewn in ties, washable up to +90°C, with pocket slits



Art-Nr. Part No.	Länge Length cm	Breite Width cm
6553/094	90	70
6553/114	110	90



Schürze mit Latz

weiß, aus 100% Baumwolle (Körper), Gewicht 210 GSM (g/m²), Bänder 2,5 cm breit und ca. 50 cm lang, waschbar bis +90°C

Bib Apron

white, 100% cotton twill, 210 gsm, with approx. 50 x 2.5 cm sewn in ties, washable up to +90°C



Art-Nr. Part No.	Länge Length cm	Breite Width cm	Anzahl Fächer Slots
aus Schweinsleder: / pigskin:			
5836/175	19	10,5	7
aus Lederimitat: / artificial leather:			
5836/190*	17,5	10	8
* zusätzliches Rückenfach, außen			
* with additional back pocket			



Kellnergeldtasche

aus weichem dünnen Material, dadurch schlankes Design und geringes Eigenvolumen, Geldscheinfächer, Münzfach und Reißverschlussfach, mit Öse für Kette

Waiters Purse

smooth thin material, banknote, coin and zipper pockets, with loop for chain

Art-Nr. Part No.	Länge Length cm	Breite Width cm
5838/890	21,5	15



Kellnergürteltasche

Revolvertasche zu Kellnerbörse, aus schwarzem Polyurethan

Waiters Purse

black polyurethane



Kassenschlüsselkette

60 cm langer flexibler Auszugsdraht,
mit Befestigungsclip, Schlüsselring

Key ring retractable

60 cm spring wire, with clip and key-ring



Art-Nr. Part No.	∅ dia. cm	Dicke Thickness cm
5837/320	4	1,2

Rechnungsmappe

aus schwarzem edlem Kunstleder,
neutral ohne Aufdruck

Bill Presenter

black artificial leather



Art-Nr. Part No.	Länge Length cm	Breite Width cm
5834/230	23	13

Design passend zu Speisekarten 5831 auf Seite 479: / Design matches 5831 menu holders on page 479:

Klassisches Design mit Metallecken: / Classic design with metallic corners:		
5834/233	23	13

Rechnungsmappe

Münzfach aus lackiertem Holz,
Deckel aus echtem Leder, mit Gummiband

Bill Presenter

wooden coin holder, leather look cover,
with rubber band



Art-Nr. Part No.	Länge Length cm	Breite Width cm	Höhe Height cm
3859/180	18	10	1,8

Zahlteiler

aus Acryl, mit vier Rutschstoppern, schwere Qualität

Tip Tray

acrylic, with four non-slip feet, heavy gauge



Art-Nr. Part No.	Länge Length cm	Breite Width cm	Höhe Height cm
6775/220	22	15	2

Geldkassette

aus lackiertem Stahlblech, mit Zylinderschloss und zwei
Schlüsseln, Hartgeldeinsatz aus stabilem Polystyrol
mit 5 Fächern, Deckel mit umklappbarem Griff

Cash Box

lacquered steel, with cylinder lock, equipped
with 2 keys, with polystyrene coin insert with
5 compartments, lid with movable handle



Art-Nr. Part No.	Länge Length cm	Breite Width cm	Höhe Height cm	Farbe Colour
4365/200	20	16	9	schwarz/black
4365/250	25	18	9	blau/blue
4365/300	30	24	9	rot/red

Art-Nr.	∅ Boden	Höhe
Part No.	∅ Base	Height
1049/220	9 cm	22 cm



Bon-/ Zettelspieß

aus Edelstahl 18/10, hochglänzend,
3,3 mm Spießdurchmesser, Spitze geschärft

Bill Spike

18/10 stainless steel, mirror polished finish,
spike diameter 3.3 mm, sharpened top



Art-Nr.	∅ Boden	Höhe
Part No.	∅ Base	Height
1050/155	8 cm	15,5 cm



Bon-/ Zettelspieß

aus 3 mm starkem, doppelt verchromtem Stahldraht

Bill Spike

3 mm chrome plated wire



Art-Nr.	Länge	Breite	Höhe	Anzahl Drähte
Part No.	Length	Width	Height	Wires
	cm	cm	cm	
1041/001	7	6	11	1
1041/003*	19,5	6	11	3

*mit stumpfem Ende zur Unfallverhütung

*with blunt end for safe handling



Bon-/ Zettelspieß

mit Holzfuß, Spieße aus Kunststoff

Bill Spike

wooden base, plastic spikes



Art-Nr.	Höhe	Länge	Tiefe
Part No.	Height	Length	Depth
	cm	cm	cm
7530/061	10	61	2
7530/091	10	91,5	2



Bonschiene

aus Edelstahl 18/0, mit Kugel-Klemmsystem,
zur Wandmontage, auch mit Pinboard-Magneten nutzbar

Bill Rail

18/0 stainless steel, for wall mounting,
usable also with pin board magnets



Art-Nr.	Höhe	Länge	Tiefe
Part No.	Height	Length	Depth
	cm	cm	cm
7533/030	6	30	2,5
7533/046	6	46	2,5
7533/061	6	61	2,5



Bonschiene

aus Aluminium, mit Kugel-Klemmsystem,
zur Wandmontage

Bill Rail

aluminium, wall fitting



Art-Nr.	Höhe	Länge	Tiefe
Part No.	Height	Length	Depth
	cm	cm	cm
7532/030	2,8	31	2
7532/045	2,8	46	2
7532/060	2,8	61	2



Bonschiene, schmal

aus rostfreiem Edelstahl 18/0, mit Kugel-Klemmsystem,
ideal zur Montage auf die Kanten von
Regalbretern oder Tischen

Bill Rail

stainless steel 18/0, ideal for fitting to thick shelves



Bratenthermometer

Prüfstab und Fassung aus Edelstahl 18/10,
Scheibe aus Glas, Messbereich 0°C bis +120°C,
Tiersymbole als Garhilfe

Roasting Thermometer

18/10 stainless steel probe and frame, glass window,
measures from 0°C to +120°C, animal symbols help
indicate the correct temperature



Art-Nr.	Länge	∅ oben
Part No.	Length	∅ Top
7876/050	11 cm	5



Fritteusenthermometer

Prüfstab, Fassung und Clip aus Edelstahl,
Scheibe aus ABS, Messbereich 0°C bis +250°C,
zum Dauereinsatz in der Fritteuse

Deep Fat Fryer Thermometer

stainless steel probe, frame and clip, ABS window,
measures from 0°C to +250°C



Art-Nr.	Länge	∅ oben
Part No.	Length	∅ Top
7877/045	14 cm	4,5 cm



Thermometer

Prüfstab und Fassung mit Klemme aus Edelstahl 18/10,
Scheibe aus ABS, Schutzkappe aus Polypropylen,
Messbereich -10°C bis +100°C, kalibrierbar,
Messgenauigkeit etwa +/- 2°C, weites Einsatzfeld für
Messungen an Fleisch, Getränken u.a.

Thermometer

18/10 stainless steel, ABS window, with polypropylene
cover, measures from -10°C to +100°C,
can be calibrated to +/- 2°C, wide range of use
including hot milk



Art-Nr.	Länge	∅ oben
Part No.	Length	∅ Top
7874/140	14 cm	2,5 cm

Passt in Halter 7870/110.
Matches clip 7870/110.



Milchschaum-Thermometer

Prüfstab und Fassung mit Klemme aus Edelstahl,
Schutzkappe und Sichtscheibe aus Polycarbonat,
Messbereich -15°C bis +100°C, farbige Hervorhebung
des optimalen Temperaturbereichs, kalibrierbar,
einschließlich Clip

Barista Thermometer

stainless steel, with polycarbonate sleeve and face,
measures from -15°C to +100°C, coloured area of ideal
temperatures, supplied with clip



Art-Nr.	Länge	∅ oben
Part No.	Length	∅ Top
7868/165	16,5	4





Art-Nr. Part No.	Länge Length
klein, Stab bis Ø 4 mm: / small, Ø 4 mm: 7870/110	4 cm
groß, Stab bis Ø 3 mm: / large, Ø 3 mm: 7870/111	9 cm

Passendes Thermometer beispielsweise 7874 von Seite 420.
Fits to thermometer 7874 on page 420.



Thermometer Clip

aus Edelstahl 18/10, hochglänzend, 15 mm breite Klemmhalterung, Stab-Thermometer können an Behältern befestigt werden

Thermometer Clip

18/10 stainless steel, mirror polished finish, 15 mm wide steel, to hold thermometers safely in pots and jugs



Art-Nr. Part No.	Länge Length	Ø dia.
7871/150	15 cm	0,6 cm



Weinthermometer

aus Glas, Temperaturbereich 0°C bis +40°C, mit Aufhängeöse aus verchromten Zinkguss

Wine Thermometer

glass, for temperatures from 0°C to +40°C, with chrome plated hanging loop



Art-Nr. Part No.	Ø dia.
7875/070	7 cm



Kühlraumthermometer

Messbereich von -50°C bis +50°C, Gehäuse aus ABS,

Fridge/Freezer Thermometer

measures from -50°C to +50°C, plastic frame



Art-Nr. Part No.	Länge Length	Ø dia.
7879/210	20,5 cm	2 cm



Kühlraumthermometer

Gehäuse aus Polystyrol, Messbereich von -45°C bis +30°C, farbig markierte Temperaturbereiche

Freezer Thermometer

polystyrene frame, measures from -45°C to +30°C, coloured temperature ranges



Allergen-Thermometer

von Comark®, batteriebetrieben,
Temperaturbereich -50°C bis +200°C,
Genauigkeit 0,1°C, extra dünne Spitze,
Gehäuse aus ABS mit antibakterieller Beschichtung

Allergen Digital Thermometer

Comark®, battery powered, measures from -50°C to
+200°C, accurate to 1°C, extra fine needle,
ABS case with antimicrobial protection



Art-Nr. Part No.	Länge Length cm	∅ Draht ∅ Wire mm
7860/150	7	1,5

Infrarot Thermometer

von Comark®, batteriebetrieben, mit digitaler Anzeige,
kontaktloses Messen mit Laser von -30°C bis +200°C

Infra Red Digital Thermometer

Comark®, battery powered,
measures from -30°C to +200°C using a laser



Art-Nr. Part No.	Länge Length cm
7850/100	15

Digitales Klappthermometer

von Comark®, batteriebetrieben, mit digitaler Anzeige,
einklappbare Einstechnadel aus Edelstahl, Messbereich
von -40°C bis +125°C, extra dünne Spitze, Leuchtdio-
den "Frozen", "Chilled" und "Cooked" für eine schnelle
HACCP Prüfung, spritzwassergeschützt

Digital Folding Thermometer

Comark®, battery powered, stainless steel retractable
fine tipped probe, measures from -40°C to 125°C,
displays "Frozen", "Chilled" and "Cooked" for a quick
HACCP test, splash proof



Art-Nr. Part No.	Zinkenlänge Prongs Length cm	Länge Length cm	Breite Width cm	Höhe Height cm
7853/110	11	17	5	2

Mini-Einstechthermometer

von Comark®, Temperaturbereich -40°C bis +150°C,
Genauigkeit 0,1°C, extra dünne Spitze, Gehäuse aus
ABS mit antibakterieller Beschichtung, einschließlich
Schutzhülle und Clip

Digital Thermometer

Comark®, ABS with anti-microbial protection, battery
powered, measures from -40°C to +150°C, accurate to
0.1°C, with fine tipped probe, including protective sleeve
and clip



Art-Nr. Part No.	Länge Length cm	∅ dia. cm
7855/127	15	4

Getränke & Bar

Mit einer gut organisierten Theke erleichtern Sie sich den Getränkeauschank. Das richtige Barzubehör steigert den Genuss von Drinks, Cocktails und Getränken. **contacto** bietet ein professionelles Equipment für den Bartender und Sommelier. Getränke lassen sich so einfach und stilschön zubereiten und ausschenken.

Drinks & Barware

Choose from the wide range of bar accessories to satisfy the customer's thirst and ensure a well organised bar. Contacto offers everything for your bar and sommelier needs in order to prepare and serve drinks to the highest standard.

Seite Page
424

Wein, Sekt & Bier
Wine, Champagne & Beer

Seite Page
441

Barbedarf
Barware

Wein, Sekt & Bier

Lassen Sie die Korken knallen! Servieren, öffnen und kühlen Sie Ihre Weine, Biere und Softgetränke stilvoll und adrett. Genuss und Erfrischung sind garantiert.

Wine, Champagne & Beer

Chill, open and serve your wines, beers and soft drinks professionally. Satisfaction guaranteed.

Champagnerkühler

aus Edelstahl, innen matt, außen hochglänzend poliert

Wine Cooler

stainless steel, mirror polished finish outside, matt ground finish inside



Art-Nr. Part No.		∅ innen ∅ Inside cm	Höhe gesamt Overall Height cm
261/380	12 l	38	25

Champagnerkühler

aus Edelstahl 18/10, innen matt, außen hochglänzend, mit gebördeltem Rand

Punch Bowl/Wine Cooler

18/10 stainless steel, matt inside, mirror polished outside, rolled edge



Art-Nr. Part No.		∅ dia. cm	Höhe gesamt Overall Height cm
289/350	9 l	35	25,5

Bankett-Champagnerkühler

aus Edelstahl 18/10, innen matt, hochglänzend, mit gebördeltem Rand, extra schwere Qualität

Punch Bowl/Wine Cooler

18/10 stainless steel, matt inside, mirror polished outside, extra heavy gauge, very high quality



Art-Nr. Part No.		∅ dia. cm	Höhe gesamt Overall Height cm
291/400	15 l	40	30

Sektkühler Champagne Buckets



Art-Nr. Part No.	∅ innen ∅ Inside cm	Höhe gesamt Overall Height cm
263/450	15 l 40	30



Champagnerkühler

aus Edelstahl 18/10, hochglänzend, mit extra breitem Rand (2 cm), extra schwere Qualität

Punch Bowl/Wine Cooler

18/10 stainless steel, mirror polished finish, extra wide flat rim (2 cm) with raised half rolled edge, extra heavy gauge, very high quality



Art-Nr. Part No.	∅ dia. cm	Höhe gesamt Overall Height cm
287/385	13,5 l 38,5	26



Champagnerkühler

aus Edelstahl, außen hochglänzend, innen geschliffen, mit gebördeltem Rand, mit goldfarbenen Griffen

Punch Bowl/Wine Cooler

stainless steel, outside mirror polished, ground finish inside, rolled edge, gold plated handles



Verchromter Ring zum Einhängen von 12 Sektköhlern: / Insert for a dozen champagne glasses:
287/912

Art-Nr. Part No.	∅ innen ∅ Inside cm	Höhe gesamt Overall Height cm
266/440	15 l 39,5	25,5

Lieferung ohne Dekoration.
Supplied without decoration.



Champagnerkübel

aus klarem, transparenten Polycarbonat, schwerer Fuß aus Edelstahl, bruchfest und stabil

Punch Bowl/Wine Cooler

clear transparent polycarbonate, heavy foot made of stainless steel, break resistant



Art-Nr. Part No.	Länge Length cm	Breite Width cm	Höhe Height cm
---------------------	-----------------------	-----------------------	----------------------

Für eine Flasche: / For one bottle:

6767/220	22	16	23,5
----------	----	----	------

Für zwei Flaschen: / For two bottles:

6767/280	28	17	23,5
----------	----	----	------

Ab drei Flaschen: / 3 bottles or more:

6767/485	48	21	24,5
----------	----	----	------

Lieferung ohne Dekoration.
Supplied without decoration.



Sektkühler, oval

aus klarem Acryl

Oval Ice Bucket

clear acrylic



Art-Nr. Part No.	Länge Length cm	Breite Width cm	Höhe Height cm
---------------------	-----------------------	-----------------------	----------------------

für eine Flasche: / for one bottle:

6760/220	20	20	23
----------	----	----	----

für zwei Flaschen: / for 2 bottles:

6760/290	29,5	18,5	24
----------	------	------	----

für 4 Flaschen: / for 4 bottles

6760/450	46,5	25	26
----------	------	----	----

Lieferung ohne Dekoration.
Supplied without decoration.



Sektkühler, oval

aus schwarzem Acryl

Oval Ice Bucket

black acrylic



Sektkühler

aus Acryl, mit seitlichen Knopfgriffen,
für Sektflaschen mit max. 0,75 l Volumen

Champagne Bucket

acrylic, for bottles up to 0.75 L



Art-Nr.	∅ oben	Höhe
Part No.	∅ Top	Height

PRODUKTION
EINGESTELLT
PRODUCTION
DISCONTINUED

Sektkühler

aus Aluminium, außen glänzend poliert,
mit zwei Fallgriffen

Champagne Bucket

aluminium, outside mirror polished, two handles



Art-Nr.	∅ außen	Höhe
Part No.	∅ Outside	Height
264/220	19 cm	22 cm

Passt auf Sektkühlerständer 262/195, 296/675, 259/750 (mit 259/194)

Matches stand 262/195, 296/675, 259/750 (with 259/194)

Sektkühler

aus Edelstahl, außen hochglänzend poliert, innen matt
gebürstet, für Standard- und Magnum-Flaschen

Champagne Bucket

stainless steel, outside mirror polished,
inside satin polished finish, takes a magnum bottle



Art-Nr.	∅ oben	Höhe
Part No.	∅ Top	Height
268/200	20 cm	25 cm

Passt auf Sektkühlerständer 269/710, 259/750 (mit 259/201).

Matches stand 269/710, 259/750 (with 259/201).

Sektkühler

aus Edelstahl 18/10, hochglänzend,
mit gebördeltem Rand, schwere Qualität

Champagne Bucket

18/10 stainless steel, mirror polished finish,
rolled edge, heavy gauge



Art-Nr.	∅ oben	Höhe
Part No.	∅ Top	Height

Für Pikkolos oder als Eiseimer: / For ¼ bottles (0.2 L) or as ice bucket:

260/170 16,5 cm 16 cm

Für 0,75 l-Flaschen: / For a 0.75 L bottle:

260/210* 21 cm 20 cm

Für 2 Standard-, bzw. eine Magnumflasche: / For 2 standard, or 1 magnum bottle:

260/240** 23 cm 23 cm

*Passt auf Sektkühlerständer 262/195, 296/675, 297/640, 259/750 (mit 259/194).

**Passt auf Sektkühlerständer 262/220, 259/750 (mit 259/223).

*Matches stand 262/195, 296/675, 297/640, 259/750 (with 259/194).

**Matches stand 262/220, 259/750 (with 259/223).

Sektkühler

aus Edelstahl, hochglänzend, mit zwei Fallgriffen

Champagne Bucket

stainless steel, mirror polished finish, open edge



Art-Nr.	∅ oben	Höhe
Part No.	∅ Top	Height
288/210	18,5 cm	18,5 cm

Passt auf Sektkühlerständer 262/195, 296/675, 297/640

Matches stand 262/195, 296/675, 297/640

Sektkühlerständer -und halter

Champagne Bucket Stands



contacto

Art-Nr. Part No.	∅ dia.	Höhe Height
---------------------	-----------	----------------

Für Pikkolos oder als Eiseimer: / Ice Bucket

298/140	13,5 cm	13 cm
---------	---------	-------

Für 0,75 l-Flaschen: / Champagne Bucket

299/210*	22 cm	20 cm
----------	-------	-------

*Passt auf Sektkühlerständer 296/675, 259/750 (mit 259/194)

*Matches stand 296/675, 259/750 (with 259/194)



Sektkühler

aus Edelstahl, außen hochglänzend, innen matt poliert, mit gebördeltem Rand, schwere Qualität

Champagne Bucket

stainless steel, mirror polished, with open edge, heavy gauge



Art-Nr. Part No.	∅ dia.	Höhe Height
---------------------	-----------	----------------

Passt auf Sektkühlerständer 262/195, 269/710, 296/675, 259/750 (mit 259/201)

Matches stands 262/195, 269/710, 296/675, 259/750 (with 259/201)



Sektkühler

aus Edelstahl 18/10, hochglänzend poliert, mit Griffband, stapelbar, schwere Qualität

Champagne Bucket

18/10 stainless steel, mirror polished finish, stackable, heavy gauge



Art-Nr. Part No.	∅ oben ∅ Top	Höhe Height	1,1 l
---------------------	-----------------	----------------	-------

391/120	11,5 cm	12 cm	1,1 l
---------	---------	-------	-------



Sektkühler

aus Edelstahl, hochglänzend, schwere Qualität, ideal auch als Tischabfallbehälter

Champagne Bucket

stainless steel, mirror polished finish, heavy gauge, also suitable as table top waste bin



Art-Nr. Part No.	∅ innen ∅ Inside	Höhe außen Outer Height
---------------------	---------------------	----------------------------

Hochglänzend poliert, Flaschendicke max. ∅ 9,5 cm: / Mirror polished finish, max. ∅ of bottle: 9.5 cm:

2377/195	10,5 cm	19 cm
----------	---------	-------

Seidenmatt poliert, Flaschendicke max. ∅ 9,5 cm: / Satin polished finish, max. ∅ of bottle: 9.5 cm:

2378/195	10,5 cm	19 cm
----------	---------	-------

Für Pikkolos, seidenmatt poliert: / For small bottles, satin polished finish:

2374/120	6,5 cm	12 cm
----------	--------	-------

Art-Nr. Part No.	∅ innen ∅ Inside	Höhe außen Outer Height
---------------------	---------------------	----------------------------

6787/230	9,5 cm	23 cm
----------	--------	-------

Lieferung ohne Dekoration.

Supplied without decoration.



Wein-/Flaschenkühler, doppelwandig

ganz aus Edelstahl 18/10, doppelwandig isoliert, schwere Qualität

Wine Cooler

insulated, double walled, all 18/10 stainless steel, heavy gauge



Weinkühler, doppelwandig

aus Acrylglas, mit verchromtem Band, hält die Temperatur der Flasche über einen langen Zeitraum konstant, ideal auch für Rotwein und vorgekühlten Sekt, Flaschendurchmesser max. 9 cm (z.B. Sektkühler 0,75 l)

Acrylic Wine Cooler

insulated, double walled, clear, with chrome plated bands, takes bottles up to ∅ 9 cm



Art-Nr. Part No.	∅ außen ∅ Outside	∅ innen ∅ Inside	Höhe Height
---------------------	----------------------	---------------------	----------------

4/200	21 cm	13 cm	12 mm
-------	-------	-------	-------

Passend für alle lieferbaren Sektkühler außer 260/240 und 268/200. Matches all our champagne buckets (except part no. 260/240 and 268/200).



Unterteller für Sektkühler

rund, aus Edelstahl 18/10, seidenmatt poliert, schützt den Tisch vor Kondenswasser

Tray for Champagne Buckets

18/10 stainless steel, satin polished finish



Sektkühlerständer

aus Edelstahl 18/10, hochglänzend,
mit hohem Rand, schwere Qualität

Champagne Bucket Stand

18/10 stainless steel, mirror polished finish,
extra deep, heavy gauge



Art-Nr. Part No.	Höhe gesamt Overall Height cm	∅ innen ∅ Inside cm	Höhe Behälter Container Height cm
---------------------	-------------------------------------	---------------------------	---

262/195	59,5	18,5	7
Passend zu Kühler 260/210, 264/220, 288/210, 396/210, 8892/210			
Matches 260/210, 264/220, 288/210, 396/210, 8892/210 buckets			

262/220	59,5	21	7
Passend zu Kühler 260/240			
Matches 260/240 bucket			

Einfache Selbstmontage.
Supplied flat packed.

Sektkühlerständer

aus Edelstahl, hochglänzend, extra hoher Rand,
schwere Qualität

Champagne Bucket Stand

stainless steel, mirror polished finish, extra deep



Art-Nr. Part No.	Höhe gesamt Overall Height cm	∅ innen ∅ Inside cm	Höhe Behälter Container Height cm
---------------------	-------------------------------------	---------------------------	---

296/675	67,5	18	10
Passend zu Kühler 260/210, 264/220, 288/210, 299/210, 396/210, 8892/210			
Matches buckets 260/210, 264/220, 288/210, 299/210, 396/210, 8892/210			

Sektkühlerständer

aus Edelstahl 18/10, hochglänzend, mit niedrigem Rand,
extra schwere Qualität

Champagne Bucket Stand

18/10 stainless steel, mirror polished finish



Art-Nr. Part No.	Höhe gesamt Overall Height cm	∅ innen ∅ Inside cm	Höhe Behälter Container Height cm
---------------------	-------------------------------------	---------------------------	---

297/640	64	17,5	2,5
Insbesondere passend zu Kühler 260/210, 288/210, 8892/210			
Especially matches buckets 260/210, 288/210, 8892/210			

Sektkühlerständer -und halter

Champagne Bucket Stands



contacto

Art-Nr. Part No.	Höhe gesamt Overall Height cm	∅ innen ∅ Inside cm
259/750	75	

Passenden Ringaufsatz hierzu bitte separat bestellen:
Please order separately the ring top which matches to your ice bucket:

259/194	19,4	
passend zu Sektkühler 260/210, 264/220, 299/210, 8892/210 matches champagne buckets 260/210, 264/220, 299/210, 8892/210		

259/201	20,5	
passend zu Sektkühler 268/200, 396/210 matches champagne buckets 268/200, 396/210		

259/223	22,3	
passend zu Sektkühler 260/240 matches champagne buckets 260/240		

Lieferung ohne abgebildeten Kühler.
Supplied without illustrated bucket.



Universal-Sektkühlerständer

aus verchromtem 7 mm starkem Stahldraht, schwere Qualität, die Ringaufsätze sind auswechselbar; der Ständer kann somit an unterschiedlich große Sektkühler angepasst werden

Champagne Bucket Stand

7 mm chrome plated wire, heavy gauge, interchangeable ring tops, matches to a large variety of champagne buckets



Art-Nr. Part No.	Höhe Height cm
269/710	71

Insbesondere passend zu Kühler 268/200, aber auch 396/210
Especially matches 268/200 bucket, also 396/210



Sektkühlerständer

aus hochglanzverchromten 10 mm Stahlrohr, hochglänzend, einfache Selbstmontage

Champagne Bucket Stand

chrome plated steel tube, mirror polished, supplied unassembled



Art-Nr. Part No.	∅ innen ∅ Inside cm	Höhe Height cm	Länge Length cm
292/002	18,4	17	50

Passend zu allen lieferbaren Sektkühlern außer 260/240 und 268/200.
Suitable for all available champagne buckets (except part no. 260/240 and 268/200.)



Tischhalterung

für Sektkühler, aus 8 mm starkem verchromtem Stahldraht

Champagne Bucket Holder

for tables, 8 mm chrome plated wire



Art-Nr. Part No.	∅ dia. cm
293/200	20 cm

Passend zu allen lieferbaren Sektkühlern außer 260/240.
Suitable for all available champagne buckets (except part no. 260/240.)



Tischhalterung

für Sektkühler, aus 7 mm starkem verchromtem Stahldraht, mit Aluminiumplatte

Champagne Bucket Holder

for tables, 7 mm chrome plated wire, with aluminium base plate



Weinflaschenständer

aus verchromtem Stahldraht, für 6 Flaschen 0,75 l, mit Tragegriff

Wine Bottle Holder

chrome plated steel wire, for up to six 0.7 l bottles, with carrying handle



Art-Nr. Part No.	Höhe Height cm	Ø dia. cm
2388/006	57	22

Lieferung ohne Dekoration.
Supplied without decoration.

Weinflaschen-Präsentier

Abstellfläche aus Holz, kupferfarben beschichtetes Drahtgestell, mit Schreiftafeln aus schwarzem PVC, gut zu reinigen, zum Präsentieren des Weinangebots

Wine Bottle Presenter

wooden base, coated wire stand, with black PVC boards, easy to clean



Art-Nr. Part No.	Länge Length cm	Breite Width cm	Höhe Height cm	Ø Glas max. Ø Glass max. cm
2382/001	11	11	45	9

für 1 Flasche: / for 1 bottle:

2382/001	11	11	45	9
----------	----	----	----	---

Lieferung ohne Dekoration.
Supplied without decoration.

Dekantierständer

aus versilbertem Stahldraht, Silberschicht 0,5µ, anlaufgeschützt, nicht spülmaschinengeeignet, für 0,75 l-Flaschen, hochwertige Qualität

Wine Basket

0.5 micron silverplated steel, not dishwasher proof, for 0.75 L bottles



Art-Nr. Part No.	Länge außen Outer Length cm	Breite außen Outer Width cm	Höhe gesamt Overall Height cm
4407/240	24	11	18

Lieferung ohne Dekoration.
Supplied without decoration.

Dekantierständer / Weinflaschenhalter

hochglänzend verchromt, mit Trageschlaufen, schwere Qualität

Wine Cradle

mirror chrome plated, with moulded handles, heavy gauge



Art-Nr. Part No.	Ø max. cm	Höhe Height cm	Länge Length cm
2380/250	10	19	25

Lieferung ohne Dekoration.
Supplied without decoration.

Karaffenständer

aus Edelstahl 18/0, mit Kunststoffkappe, zum Trocknen von Karaffen und Gläsern

Drying Stand

18/0 stainless steel, with plastic top, for drying carafes and glasses



Art-Nr. Part No.	Ø dia. cm	Höhe Height cm
7569/320	22,5	32

Lieferung ohne Karaffe.
Supplied flat packed without carafe.

Art-Nr. Part No.	∅ dia. cm	Höhe Height cm	
2352/100	11,5	14	1 l



Degustationsbehälter

aus Edelstahl 18/10, Spucknapf mit Spritz- und Sichtschutz für Weinmessen und Verkostungen

Spittoon

18/10 stainless steel, for wine tasting



Art-Nr. Part No.	Länge Length cm	∅ dia. cm
7871/150	15	0,6



Weinthermometer

aus Glas, Temperaturbereich 0°C bis +40°C, mit Aufhängeöse aus verchromten Zinkguss

Wine Thermometer

glass, for temperatures from 0°C to +40°C, with chrome plated hanging loop



Art-Nr. Part No.	Breite Width cm	∅ außen ∅ Outside cm	∅ innen ∅ Inside cm
24/040	2	4	3



Tropfenfänger

für Weinflaschen, aus verchromtem Messing, hochglänzend, rote Filzeinlage zum Reinigen leicht herausnehmbar

Wine Collar

chrome plated brass, mirror polished finish, red felt can be easily removed for cleaning



Art-Nr. Part No.	Länge Length cm	∅ max. cm
379/090	9	2,3



Weinflaschenausgießer

aus Edelstahl, mit abnehmbarem Gummilamelle, passend in handelsübliche Weinflaschen

Wine Pourer

stainless steel, with removable rubber insert, fits into standard wine bottles



Art-Nr. Part No.	Breite Width cm	Höhe Height cm
378/075	7,5	7,5

Preis und Verpackung à 6 Stück.
Priced/packed in 6's.



Weinausgießerfolie

lebensmittelechte Folie zum Einschieben in den Flaschenhals, verhindert das Nachtropfen

Foil Pourer

food safe foil for wine bottles



Art-Nr. Part No.	Länge Length cm	Breite Width cm	∅ max. cm
376/070	7	4,5	3,5



Folienschneider

für Weinflaschen, aus flexiblem Kunststoff, mit Schneidbacken aus Edelstahl

Foil Cutter

flexible plastic, with stainless steel cutters



Barzange

aus Edelstahl 18/0, hochglänzend, schwere Qualität, mit Zange zum Draht- und Folienschneiden, Kapselheber und Entkorkhilfe



Art-Nr.
Part No.
225/180

Länge
Length
18 cm

Champagne Opener

18/0 stainless steel, mirror polished finish, heavy gauge



Entkorkmaschine

zur Thekenmontage, aus verchromtem Zinkguss, mit Edelholzgriff, für Tischplatten bis 4,5 cm, schwere Qualität



Art-Nr.
Part No.

Länge
Length

1100/001

54,5 cm

1100/913

Ersatzspindel / Spare worm

Cork Extractor

chrome plated cast zinc alloy with wooden handle, safety collar and clamp, heavy duty, for work surfaces up to 4.5 cm thick



Kellnermesser

arbeitet nach dem Doppelheberprinzip, daher auch für große Flaschen geeignet, aus massivem Edelstahl 18/0, Griff kunststoffbeschichtet, mit Korkenzieher, Messer und Kapselheber



Art-Nr.
Part No.
377/120

Länge
Length
12 cm

Waiters Friend

for large bottles, 18/0 stainless steel, plastic coated handle, with corkscrew, knife and bottle opener



Kellnermesser

mit rot-grauem Antirutschgriff, Arbeitsteil aus massivem Edelstahl 18/0, mit Korkenzieher, Messer und Kapselheber



Art-Nr.
Part No.
372/130

Länge
Length
13,5 cm

Waiters Friend

with non-slip handle, 18/0 stainless steel, with corkscrew, knife and bottle opener



Kellnermesser

aus massivem Edelstahl 18/0, ergonomisch gebogene Form, mit Korkenzieher, Messer und Kapselheber



Art-Nr.
Part No.
319/110

Länge
Length
11 cm

Waiters Friend

18/0 stainless steel, ergonomically shaped, with corkscrew, knife and bottle opener



Kellnermesser

aus Edelstahl 18/0, ABS Kunststoff-Griff, ergonomisch gebogene Form, mit Korkenzieher, Messer und Kapselheber



Art-Nr.
Part No.
312/120

Länge
Length
12 cm

Waiters Friend

18/0 stainless steel, black ABS handle, with corkscrew, knife and bottle opener





Art-Nr.	Länge
Part No.	Length
314/150	11 cm



Kellnermesser

aus Edelstahl 18/0, hochglänzend, mit Messer, Korkenzieher und Kapselheber

Waiters Friend

18/0 stainless steel, mirror polished finish, with corkscrew, knife and bottle opener



Art-Nr.	Länge
Part No.	Length
315/150	13 cm



Kellnermesser

aus Edelstahl 18/0, hochglänzend, mit Messer, Korkenzieher und Kapselhebern

Waiters Friend

18/0 stainless steel, mirror polished finish, with corkscrew knife and bottle openers



Art-Nr.	Länge
Part No.	Length
318/150	14,5 cm



Kellnerkorkenzieher

aus Edelstahl 18/0, hochglänzend, mit Korkenzieher und Kapselhebern

Waiters Friend

18/0 stainless steel, mirror polished finish, with corkscrew and bottle openers



Art-Nr.	Länge
Part No.	Length
453/195	19,5 cm



Hebelkorkenzieher

aus hochglänzend verchromten Messing, mit Kunststoffeinsätzen abgesetzt, Drehflügel ist auch Kapselheber, schwere Qualität

Corkscrew

chrome plated brass, with plastic, with bottle opener, extra heavy gauge



Art-Nr.	Länge
Part No.	Length
454/180	17,5 cm



Hebelkorkenzieher

aus hochglänzend verchromten Messing, Drehflügel ist auch Kapselheber

Corkscrew

chrome plated brass, with bottle opener, mirror polished



Art-Nr.	Länge	Höhe
Part No.	Length	Height
375/001	18 cm	15 cm



Hebelkorkenzieher

aus Aluminiumguss, formschönes Gerät zum Öffnen von Weinflaschen, mit beiliegendem Folienschneider

Cork Extractor

cast aluminium



Kapselheber

aus Edelstahl 18/0, hochglänzend, mit Griff aus schwarzem Polypropylen, mit Aufhängeöse

Bottle Opener

18/0 stainless steel, mirror polished finish, black polypropylene handle with hanging loop



Art-Nr. Part No.	Länge Length
4071/145	14,5 cm

Kapselheber / Dosenlocher

Serie POLARIS, mit seidenmatt poliertem Griff aus Edelstahl 18/10, Arbeitsteil aus hochglänzendem Edelstahl 18/0

Bottle Opener

with hanging loop, handle 18/10 stainless steel, opener 18/0 stainless steel, mirror polished



Art-Nr. Part No.	Länge Length
925/185	18,5 cm

Kapselheber

vernickelt, mit Buchenholzgriff

Bottle Opener

nickel plated, with beech wood handle



Art-Nr. Part No.	Länge Length
371/140	14 cm

Kapselheber

hochglänzend verchromt

Bottle Opener

chrome plated, mirror polished finish



Art-Nr. Part No.	Länge Length
353/010	10 cm

Kapselheber

aus gehärtetem Edelstahl, ergonomisch gestaltet für ermüdungsfreies Arbeiten

Bottle Opener

hardened stainless steel, ergonomic design



Art-Nr. Part No.	Breite Width	Länge gesamt Total Length
373/150	4,5 cm	15 cm

Speed Flaschenöffner

aus Edelstahl, glänzend poliert, schwere Qualität, mit V-Öffnung am Speedring zum Herausziehen von festsitzenden Ausgießern aus Flaschen

Bar Blade

Speed Bottle Opener, stainless steel, polished finish, heavy gauge, with V-slot used for extracting pourers



Art-Nr. Part No.	Länge Length	Breite Width	Stärke Thickness
354/180	18 cm	4 cm	2,0 mm

Beschriftung auf Anfrage.

Etching on request.

Speed Flaschenöffner

aus Edelstahl, glänzend poliert, mit Grifffläche aus blauem Vinyl

Bar Blade

Speed Bottle Opener, stainless steel, mirror polished finish, with blue vinyl cover for better grip



Art-Nr. Part No.	Länge Length	Breite Width	Stärke Thickness
362/180	18 cm	4 cm	2,0 mm

Flaschenverschlüsse

Bottle Resealers



contacto

Art-Nr. Part No.	Größe Size cm
361/001	7 x 4,5

Lieferung ohne Montagematerial.
Supplied without mounting material.



Flaschenöffner
für die Wandmontage, aus speziell gehärtetem Edelstahl 18/0, hochglänzend, extra schwere Qualität

Wall Bottle Opener
wall fitting, 18/0 hardened stainless steel, mirror polished finish, heavy duty



Art-Nr. Part No.	Höhe Height cm	Breite Width cm
359/001	10	5



Flaschenöffner
für die Wandmontage, hochglanzvernickelt, inklusive Montageschrauben

Wall Bottle Opener
wall fitting, nickel-plated mirror polished finish, includes mounting material



Art-Nr. Part No.	Länge Length cm	Breite Width cm	Höhe Height cm

PRODUKTION
EINGESTELLT
PRODUCTION
DISCONTINUED



Kapselheber mit Flaschenverschluss
zusammenklappbar, verchromter Stahl mit weicher Kunststoffdichtung

Bottle Opener and Resealer
chrome plated steel with soft plastic seal



Art-Nr. Part No.	Höhe gesamt Overall Height cm	Breite Width cm	Tiefe Depth cm	Höhe Behälter Container Height cm
326/240	23,5	14	8	16,5



Kronkorken-Auffangbehälter
für die Wandmontage, aus Edelstahl 18/10, seidenmatt gebürstet, mit verstärktem Rand

Bottle Cap Catcher
wall fitting, 18/10 stainless steel, matt polished finish



Art-Nr. Part No.	Ø max. Length cm	Länge Length cm
358/085	2,8 cm	8,5 cm



Flaschenverschluss
aus massivem Edelstahl, mit Gummiring

Wine Stopper
stainless steel with rubber ring



Art-Nr. Part No.	Ø dia. cm	Höhe Height cm
352/040	3 cm	4 cm



Flaschenverschluss
aus Polypropylen, mit verchromtem Hebel, schließt tropfdicht, für Flaschen mit Ausguss-Ø maximal 2 cm

Bottle Resealer
polypropylene, with chrome plated lever, for bottlenecks internally up to 2 cm Ø



Art-Nr. Part No.	Ø dia. cm	Höhe Height cm
350/058	3,5 cm	5,5 cm



Sektflaschenverschluss
hochglänzend verchromt

Champagne Bottle Resealer
chrome plated, mirror polished finish



Bierglasträger, rutschfest

aus glasfaserverstärktem schwarzen Polyester, schlagfest und bruchstabil, spülmaschineneignet, rutschfest, temperaturresistent von -50°C bis +140°C, säure-, laugen- und UV-beständig, im Stapel belüftbar

Beer Glass Tray, non slip

fibreglass reinforced black polyester, with drying/stacking lugs, dishwasher safe, temperature resistant from -50°C to +140°C, resistant to food acids, alcohol + UV light, virtually unbreakable



Art-Nr. Part No.	∅ dia. cm	Höhe Height cm
5356/320	32	3,5
5356/360	36	4

Bierglasträger

aus Edelstahl, mit Stapelschulter

Beer Glass Tray

stainless steel, stackable



Art-Nr. Part No.	∅ dia. cm	Höhe Height cm
1255/320	32 cm	4 cm
1255/360	36 cm	5,5 cm

Bierglasträger

aus Edelstahl, seidenmatt, mit gebördeltem Rand

Beer Glass Tray

stainless steel, satin polished finish, with rolled edge



Art-Nr. Part No.	∅ dia. cm	Höhe Height cm
1257/320	32 cm	4 cm
1257/360	36 cm	4 cm

Antirutschmatte

aus schwarzem Kunststoffgewebe, für Bierglasträger und Tablett, zuschneidbar

Non Slip Mat

black plastic sponge, inlay for glass trays, can be cut to size



Art-Nr. Part No.	∅ dia. cm
1259/330	33 cm

Glasträger

aus blauem Kunststoff, stabiler Tragegriff, zerlegbar

Glass Carrier

blue plastic, strong handle, can be taken apart



Art-Nr. Part No.	∅ dia. cm	Höhe Height cm	Anzahl Fächer Slots	∅ Glas max. ∅ Glass max.
1254/009	31,5	35	9	64 mm
für Kölsch-Gläser: / for slim glasses:				
1254/011	31,5	35	11	53 mm



Art-Nr. Part No.		∅ dia. cm	Höhe Height cm
1020/040	0,35 l	7	10



Trinkbecher mit Griff
aus Edelstahl 18/10, hochglänzend

Mug
18/10 stainless steel, mirror polished finish



Art-Nr. Part No.		∅ dia. cm	Höhe Height cm
1010/025	0,25 l	7,5	10



Trinkbecher
aus Edelstahl 18/10, außen hochglänzend

Beaker
18/10 stainless steel, outside mirror polished



Art-Nr. Part No.		∅ dia. cm	Höhe Height cm
1022/250	0,25 l	7	9



Trinkbecher mit Griff
aus Edelstahl 18/10, doppelwandig

Mug
18/10 stainless steel, insulated, double walled



Art-Nr. Part No.		∅ dia. cm	Höhe Height cm
8759/045	0,45 l	9	9



Moscow Mule Becher
aus Edelstahl, außen Kupferschicht

Copper Mug
stainless steel, with copper coating outside



Art-Nr. Part No.		∅ oben ∅ Top cm	Höhe Height cm
5345/250	0,2 l	7	10

Angegeben ist das Nutzvolumen. Ohne Maßstrich.
Working Capacity - Unmarked.



Trinkbecher
aus Polycarbonat, strukturierte Oberfläche,
insbesondere für den Einsatz in glasfreien Zonen

Beaker
polycarbonate, textured surface, with 250 ml mark,
especially for use in glass free areas



Tellerclip für Gläser

aus weißem ABS-Kunststoff, zum Feststecken von Sektflöten an den Tellerrand, kleine Kautschuk-Stopper verhindern das Abgleiten des Tellerclips, ideal für Sektempfänge und Steh-Partys



Glass Plate Clip

white ABS plastic, to hold glass to plate



Art-Nr. Part No.	∅ innen ∅ Inside	Länge Length
2082/001	3 cm	8 cm

Weinglas

aus dickem klaren SAN, insbesondere für den Einsatz in glasfreien Zonen, schwere Qualität



Wine Glass

thick clear SAN, especially for use in glass free areas, heavy gauge



Art-Nr. Part No.	Höhe Height	∅ dia.
5340/250	0,25 l 19 cm	7 cm

Angegeben ist das Nutzvolumen. Ohne Maßstrich.
Working Capacity - Unmarked.

Sektflöte

aus dickem klaren SAN, insbesondere für den Einsatz in glasfreien Zonen, schwere Qualität



Champagne Flute

thick clear SAN, especially for use in glass free areas, heavy gauge



Art-Nr. Part No.	Höhe Height	∅ dia.
5342/150	0,15 l 21 cm	5 cm

Angegeben ist das Nutzvolumen. Ohne Maßstrich.
Working Capacity - Unmarked.

Biertulpe

aus dickem klaren SAN, insbesondere für den Einsatz in glasfreien Zonen, schwere Qualität



Beer Glass

thick clear SAN, especially for use in glass free areas, heavy gauge



Art-Nr. Part No.	Höhe Height	∅ dia.
5343/040	0,3 l 18,5 cm	7 cm

Angegeben ist das Nutzvolumen. Ohne Maßstrich.
Working Capacity - Unmarked.

Pintglas

aus dickem klaren SAN, insbesondere für den Einsatz in glasfreien Zonen, schwere Qualität



Beer Glass

thick clear SAN, especially for use in glass free areas, heavy gauge



Art-Nr. Part No.	Höhe Height	∅ dia.
5344/050	0,5 l 15 cm	8,5 cm

Angegeben ist das Nutzvolumen. Ohne Maßstrich.
Working Capacity - Unmarked.



Art-Nr. Part No.	Länge Length cm	Tiefe Depth cm	Anzahl Fächer Slots
7560/450	45	31	5

Schrauben sind im Lieferumfang enthalten.
Screws included.



Gläserregal

aus 6 mm starkem verchromtem Draht, zur Befestigung mittels Schrauben unter einem Regalboden oder an der Wand, für 5 Reihen mit je 4 Gläsern mit maximal 5 cm großem Fuß

Glass Rack

6 mm chrome plated wire, can be mounted both under a shelf or directly onto the wall, for 5 rows of 4 glasses with a max. 5 cm foot



Art-Nr. Part No.	Länge Length cm	Breite Width cm
5359/230	23	2,5



Bierschaumabstreifer

aus weißem SAN Kunststoff

Froth Spatula

white SAN plastic



Art-Nr. Part No.	∅ dia. cm	Farbe Colour
---------------------	-----------------	-----------------

Biermarken "B": / "B":

7531/002	2,5	weiß/white
7531/004	2,5	blau/blue
7531/005	2,5	rot/red
7531/006	2,5	grün/green

Preis für Tüte mit je 100 Stück.
Priced and packed in 100s.



Biermarken

aus farbigem Kunststoff, mit Prägung

Tokens

coloured plastic

Art-Nr. Part No.	Länge Length cm	∅ dia. cm
5358/160	16	2,5



Bierwärmer

aus Edelstahl, mit Verschlusskappe und Abtropfhalter

Beer Warmer

stainless steel, with cap and holder



Art-Nr. Part No.	Länge Length cm	Breite Width cm	Höhe Height cm
8083/300	30	20	2,7
8083/440	44	27,5	2,7



Tropfbleche

aus matt gebürstetem Edelstahl, zum Aufsetzen auf die Theke, zum Abtropfen von Gläsern

Drip Tray

stainless steel, matt polished



Zapfhahn

Anschlaghahn aus Kunststoff, mit Sicherheits-Fass-Anstich-System

Draught Beer Tap

plastic



Art-Nr. Part No.	Länge Length cm	∅ max. cm
8087/002	18	3
8086/901	Ersatzdichtung: / Spare gasket:	

Zapfhahn

Anschlaghahn aus Messing, mit Luftventil, Stoßhahn muss mit Hammer eingeschlagen werden

Draught Beer Tap

brass, with valve, tap has to be fixed by hammer



Art-Nr. Part No.	Länge Length cm
8088/006	Hahnfett 70ml / Grease 70ml
8086/901	Hahndichtung / Gasket

PRODUKTION
EINGESTELLT
PRODUCTION
DISCONTINUED

Hahnreinigungspumpe

zum Reinigen von Zapfhähnen, mit zwei Ventilen

Tap Cleaning Pump

two valves



Art-Nr. Part No.	Länge Length cm	∅ max. cm	∅ außen ∅ Outside mm
5895/001	17	5	11 mm

Bierleitungsreiniger-Set

komplett, Gerät besteht aus vier 1/2" Schläuchen (je 1 m lang) - davon ein Druckschlauch, Schlauchschellen, je fünf 7 mm und 10 mm Schwammkugeln, einem 5/8" Adapter aus verchromten Messing, einer Bedienungsanleitung

Beer Pipe Cleaning Kit

complete set for cleaning beer pipes, with manual



Art-Nr. Part No.	Reinigungs-Set / Cleaning Kit
5893/001	20 St. Schwammkugeln 7 mm / 20 pcs. 7 mm Sponge Balls
5893/902	20 St. Schwammkugeln 10 mm / 20 pcs. 10 mm Sponge Balls

Holzhammer

aus Buchenholz, zum Anschlagen von Fässern

Wooden Mallet

beech wood, for beer barrels



Art-Nr. Part No.	Größe Size cm	Stiellänge Handle Length cm
8084/002	16 x 7,5 x 10	23

Fassbierbock

aus massivem Holz, dunkel lasiert, zum Aufsetzen von Bierfässern

Beer Barrel Stand

solid wood



Art-Nr. Part No.	Länge Length cm	Breite Width cm	Höhe Height cm
8089/350	35	35	25

Barbedarf

Martini geschüttelt oder gerührt? Beides geht mit dem Bartender-Equipment von **contacto**.
Cobbler, Fizz, Sour oder Flips? Bitter / Flair / Dash / Cobbler / Jigger? Mixen Sie mit uns!

Barware

Recreate the classics and explore new ideas with **contacto's** barware.

Art-Nr. Part No.	∅ dia. cm	Höhe Height cm
170/100	1 l	12,5
170/200	2 l	15,5
170/300	3 l	17
170/500	5 l	20
170/917	Ersatzzange / spare tongs	



Eisemmer, doppelwandig

ganz aus Edelstahl 18/10, seidenmatt poliert, mit doppelwandigem Deckel, perforiertem Einsatz und Eiszange, schwere Qualität

Insulated Ice Bucket

18/10 stainless steel, satin polished finish, double walled, with lid, tongs and perforated drainer plate, heavy gauge



Art-Nr. Part No.	Höhe Height cm	∅ außen ∅ Outside cm
2366/300	3 l	20



Eisemmer, doppelwandig

aus Edelstahl 18/10, außen hochglänzend, innen seidenmatt gebürstet, mit Tragebügel, mit doppelwandigem Deckel, mit Zange (20 cm), schwere Qualität

Insulated Ice Bucket

18/10 stainless steel, outside mirror polished finish, inside satin polished finish, double walled including lid, with tongs (20cm), heavy gauge



Art-Nr. Part No.	∅ außen ∅ Outside cm	Höhe Height cm
2357/200	2 l	15



Eisemmer, doppelwandig

aus Edelstahl, seidenmatt gebürstet, mit doppelwandigem Deckel, Tragebügel und Eiszange, schwere Qualität

Insulated Ice Bucket

stainless steel, satin polished finish, double walled body and lid, ice tong, heavy gauge



Eiseimer, doppelwandig

Außenmantel aus hochglänzendem Edelstahl 18/0, Innenwandung aus weißem Kunststoff, mit braunem einwandigem Acryl-Sichtdeckel, mit Kunststoff-Tragebügel, Lieferung mit Einsatz und Zange (14 cm)

Insulated Ice Bucket

18/0 stainless steel, mirror polished, with white plastic insulating sleeve, dark brown acrylic lid, plastic handle, with tongs (14cm) and drainer plate



Art-Nr. Part No.	Höhe Height cm	∅ außen ∅ Outside cm
2362/200	2 l	20
2362/714	Ersatzzange / Spare tongs	

Eiseimer, doppelwandig

aus Edelstahl, seidenmatt gebürstet, mit einwandigem Deckel, mit Tragebügel, schwere Qualität

Insulated Ice Bucket

stainless steel, satin polished finish, double walled body, single walled lid, heavy gauge



Art-Nr. Part No.	∅ außen ∅ Outside cm	Höhe Height cm
2365/200	1,75 l	15

Eiseimer

aus Edelstahl 18/10, hochglänzend, einwandig, mit Deckel, perforiertem Einsatz und Zange

Ice Bucket

18/10 stainless steel, mirror polished finish, with lid, tongs and perforated drainer plate



Art-Nr. Part No.	∅ außen ∅ Outside cm	Höhe gesamt Overall Height cm
2364/140	1 l	13

Eiseimer

aus Acrylglas, einwandig, mit Deckel, Einsatz und Zange

Ice Bucket

acrylic, with lid, tongs and drainer plate



Art-Nr. Part No.	∅ außen ∅ Outside cm	Höhe gesamt Overall Height cm
---------------------	----------------------------	-------------------------------------

PRODUKTION
EINGESTELLT
PRODUCTION
DISCONTINUED

Eisbehälter, doppelwandig

aus Kunststoff, mit doppelwandigem arretierbarem Deckel mit Griffmulde, mit perforiertem Einsatz

Insulated Ice Container

plastic, double walled, lockable lid with handle, with perforated insert



Art-Nr. Part No.	∅ außen ∅ Outside cm	Höhe Height cm	Farbe Colour
2360/400	4 l	22,5	24
			weiß/white

Art-Nr. Part No.	Länge Length cm	Breite Width cm	Höhe Height cm	
1919/001	16	13,5	27	0,9 l
Ersatzteile auf Anfrage. Spare parts on request.				



Eismühle

zur Zerkleinerung von Eiswürfeln, verchromt, mit Acryl-Behälter und kleiner Eisschaufel aus Kunststoff, schwere Qualität mit robustem Mahlwerk

Ice Crusher

chrome plated zinc alloy with s/s blades, with acrylic container and small plastic ice scoop, heavy gauge



Art-Nr. Part No.	Länge Length cm	Breite Width cm
1034/230	23,5 cm	6,3 cm



Eispickel

hochglanzverzinnt, mit hellem lackiertem Holzgriff, mit sechs Dornen

Ice Pick

tin plated, with lacquered wooden handle, six prongs



Art-Nr. Part No.	Höhe Height cm	∅ dia. cm	Gewicht Weight kg
1616/100	11	8,5	1



Eishammer

aus massivem Edelstahl 18/0, hochglänzend poliert, zum Trennen von Fabrikeiswürfeln im Barbetrieb

Ice Hammer

18/0 stainless steel, mirror polished finish, heavy gauge, to split factory ice



Art-Nr. Part No.	Länge Length cm	Breite Width cm	Höhe Height cm	Anzahl Fächer Slots
6752/032	33	18	3	32



Eiswürfelform

aus blauem thermoplastischem Elastomere, in schwarzer Hartschale aus Polypropylen, temperaturbeständig von -40°C bis +50°C, zur Zubereitung von 32 Eiswürfeln (35 x 30 x 25 mm)

Ice Cube Tray

blue thermoplastic elastomere, on hard black polypropylene dish, temperature resistant from -40°C to +50°C, for 32 ice cubes (35 x 30 x 25 mm)



Art-Nr. Part No.	∅ innen ∅ Inside cm
6753/050	5



Eiskugelform

zur Herstellung von runden Eiskugeln, aus Polypropylen

Ice ball mould

for making ice balls, polypropylene



Eiszange

aus Edelstahl, hochglänzend, fugenlos

Ice Tongs

stainless steel, mirror polished finish, one piece



Art-Nr.
Part No.
182/180

Länge
Length
18 cm

Eiszange

aus Edelstahl 18/10, hochglänzend, fugenlos

Serrated Ice Tongs

18/10 stainless steel, mirror polished finish, one piece



Art-Nr.
Part No.
179/180

Länge
Length
18 cm

Eiszange

aus Edelstahl 18/10, hochglänzend, fugenlos, schwere Qualität

Serrated Ice Tongs

18/10 stainless steel, mirror polished finish, one piece, heavy gauge



Art-Nr.
Part No.
164/160

Länge
Length
16 cm

Eiszange

aus Edelstahl, außen matt poliert, fugenlos

Ice Tongs

stainless steel, satin finished outside, one piece



Art-Nr.
Part No.
2370/140

Länge
Length
14 cm

Eis-/ Mehrzweckschaufel

aus Edelstahl 18/10, hochglänzend, fugenlose sehr hygienische Verbindung von Schaufel und Hohlgriff, mit Aufhängeöse, extra schwere Qualität

Scoop

18/10 stainless steel, mirror polished, seamless fixed handle, with hanging loop, extra heavy gauge



Art-Nr. Part No.	Schaufelmaß Scoop dimension cm	Länge gesamt Total Length cm	Portionsgröße Portion size
1035/110	12 x 6	21	0,1 l
1035/140	14 x 7,5	23	0,2 l
1035/155	15,5 x 8,5	24,5	0,25 l
1035/180	18 x 10	29	0,35 l
1035/220	22 x 13	35	0,5 l

Die innenliegende Kunststoffversiegelung erlaubt ein kurzzeitiges Erhitzen bis 200°C.

Temperature up to 200°C due to plastic gauge inside.

Eisschaufel

aus Edelstahl, hochglänzend, mit 5 mm-Lochung, mit handlichem Hohlgriff

Ice Scoop

stainless steel, mirror polished, 5 mm perforations, with hollow handle



Art-Nr. Part No.	Länge Length cm	∅ Schaufel ∅ Scoop cm	Schaufellänge Scoop Length cm
1031/100	18,5	5	10

Eisschaufel

aus Edelstahl 18/10, hochglänzend, mit 3 mm-Lochung, schwere Qualität

Ice & Bar Scoop

18/10 stainless steel, mirror polished finish, 3mm perforations, heavy gauge



Art-Nr. Part No.	Stiellänge Handle Length cm	∅ Schaufel ∅ Scoop cm	Schaufellänge Scoop Length cm
2097/250	26,5	5	8

Art-Nr. Part No.	∅ dia. cm	Höhe gesamt Overall Height cm
399/075	0,5 l	9,5

Ersatzglas: / Spare glass:		
399/901	0,5 l	9

Ersatzbecher: / Spare base:		
399/902	0,85 l	9,5

Angegeben ist das Nutzvolumen.
Refers to working capacity.



Boston Cocktailshaker

zweiteilig, aus hochglänzendem Edelstahl, mit Becher aus dickwandigem gehärtetem Glas

Boston Cocktail Shaker

stainless steel, mirror polished finish, with heavy thick tempered glass



Art-Nr. Part No.	∅ max. cm	Höhe gesamt Overall Height cm
398/040	0,4 l	9

Angegeben ist das Nutzvolumen.
Refers to working capacity.



Boston Cocktailshaker

zweiteilig, aus Edelstahl 18/10, hochglänzend, mit schwarzem Dichtungsring aus Santopren®, Becher aus dickwandigem Glas mit Cocktailvorschlägen (englisch) bedruckt

Boston Cocktail Shaker

18/10 stainless steel, mirror polished finish, with heavy thick glass with black Santopren® seal, with suggested cocktails



Art-Nr. Part No.	∅ max. cm	Höhe Height cm
63/025	0,25 l	7
63/035	0,35 l	7,5
63/050	0,5 l	8
63/070	0,7 l	8,5

Angegeben ist das Nutzvolumen.
Refers to working capacity.



Cobbler Cocktailshaker

dreiteilig, aus Edelstahl 18/10, hochglänzend, dichtschießend und leicht auseinander zunehmen

Cocktail Shaker

18/10 stainless steel, mirror polished finish, 3 piece



Art-Nr. Part No.	∅ max. cm	Höhe Height cm
390/050	0,8 l	9,5

Angegeben ist das Nutzvolumen.
Refers to working capacity.



Cobbler Cocktailshaker

dreiteilig, aus Edelstahl, hochglänzend, dichtschießend und leicht auseinander zunehmen

Cocktail Shaker

stainless steel, mirror polished finish, 3 piece



Art-Nr. Part No.	∅ max. cm	Höhe gesamt Overall Height cm
6785/075	0,5 l	9,5

Angegeben ist das Nutzvolumen.
Refers to working capacity.



Cobbler Cocktailshaker

dreiteilig, aus Acrylglas, weißer Aufdruck mit Maßstrichen und Zutatenangaben für die populärsten Cocktail-Drinks

Cocktail Shaker

acrylic, 3 piece, with measures, with suggested cocktails



Flair Bottle

aus weißem Copolymer-Butadien-Styrol,
zum Show-Mixen (flair bartending)

Flair Bottle

from white styrene-butadiene, for flair bartending



Art-Nr. Part No.		∅ dia. cm	Höhe Height cm
1477/075	0,75 l	8	28,5

Ausgießer bitte separat bestellen / Please order pourer separately:
5852/001

Zum Herausziehen der Ausgießer empfehlen wir den Spezial-
Kapselheber von Seite 434: / For extracting the pourer, we
recommend the bar blade on page 434:
354/180

Mini-Spiralbesen

aus Edelstahl, mit Aufhängeöse, optimal zum Zubereiten
von kleinsten Mengen feiner Saucen und Eiern,
ideal auch als Cocktail-Rührbesen

Mini Whisk

stainless steel, with hanging loop



Art-Nr. Part No.	Länge Length
828/200	20 cm



Barsieb

aus Edelstahl, hochglänzend

Cocktail Strainer

stainless steel, mirror polished finish



Art-Nr. Part No.	Länge Length	∅ max.
2096/155	15,5 cm	11 cm



Barsieb

aus Edelstahl 18/10, hochglänzend

Cocktail Strainer

18/10 stainless steel, mirror polished finish



Art-Nr. Part No.	Länge Length	∅ dia. cm
2087/210	21	8,5



Cocktail-Set

aus Edelstahl 18/10, Halterung seidenmatt gebürstet,
Sieb, Öffner, Messer und Zange aus hochglänzendem
Edelstahl 18/0, Griffe aus Edelstahl 18/10, edles,
funktionelles Design, schwere Qualität

Cocktail Set

18/10 stainless steel, satin brushed finish frame,
strainer, bottle opener, knife and tongs made of mirror
polished 18/0 stainless steel,
handles made of 18/10 stainless steel



Art-Nr. Part No.	Länge Length	Breite Width	Höhe gesamt Overall Height
2099/004	13	7	17



Art-Nr. Part No.	Länge Length cm	Breite Width cm	Höhe Height cm	Segmente Portions
581/008	20	25	40	8
581/901	Apfelschneideinsatz 8 Seg. / 8 wedge apple cutter			
581/911	Drücker zu Apfelschneideinsatz / Pusher for Apple Cutter			
581/906	Sechstel-Schneide-Einsatz / 6 wedge cutter			
581/916	Drücker zu Sechstel-Schneider / Pusher for 6 wedge cutter			
581/908	Achtel-Schneide-Einsatz / Eight segment cutter			
581/918	Drücker zu Achtel-Schneideinsatz / Pusher for 8 wedge Cutter			

Lieferung mit einem Schneideinsatz für 8 Segmente.
Shipped with one 8 segment cutter.



Apfel-/ Limettenschneider

aus Aluminiumguss, mittelschwere Ausführung, Schneidmesser aus Edelstahl, mit Gummifüßen, schneidet perfekte Stücke aus Limetten, Zitronen oder anderen Früchten, optional auch für Äpfel

Citrus Wedger

cast aluminium, medium gauge, stainless steel blades, complete with 8 wedge stainless steel cutter, rubber feet, cuts perfect wedges of lemons, limes or other citrus fruit, with option for apples



Art-Nr. Part No.	Länge Length cm	Klingenlänge Blade Length cm
994/220	22	10,5



Cocktailmesser

Serie POLARIS, Griff aus seidenmatt poliertem Edelstahl 18/10, gezahnte Klinge aus hochglänzendem geschärftem Edelstahl 18/0, mit zwei Zinken zum Aufspießen von Zitruscheiben

Bar Knife

with hanging loop, handle 18/10 stainless steel, satin polished, blade 18/0 stainless steel, serrated with two prongs



Art-Nr. Part No.	Länge Length
2247/140	14 cm



Fadenschneider

aus extra geschärftem Edelstahl 18/0, mit schwarzem glasfaserverstärktem Polyamid-Griff, zur Herstellung dünner Streifen aus Gemüse oder Zitruschalen

Zester

18/0 stainless steel, extra sharp, black fibreglass reinforced polyamide handle



Art-Nr. Part No.	Länge Length cm	Breite Width cm	Dicke Thickness cm
1590/265	26,5	18,5	1



Schneidbrett, Antirutsch-

aus schwarzem Polypropylen, mit rutschfestem grünen Rand aus thermoplastischen Elastomere, lebensmittelgeeignet, spülmaschinengeeignet, speziell geeignet für Bars

Non Slip Cutting Board

black polypropylene, with non-slip TPE green edge, food and dishwasher safe, especially suitable for bars



Zitrus-/ Limettenpresse

ganz aus Edelstahl 18/10, daher uneingeschränkt spülmaschinenfest, erfüllt alle hygienischen Anforderungen, schwere Qualität

Citrus Press

so-called 'Mexican Elbow', 18/10 stainless steel, therefore dishwasher safe, durable and sturdy quality



Art-Nr. Part No.	Länge Length cm	∅ innen ∅ Inside cm	Stiellänge Handle Length cm
806/220	22	7	13

Limetten können auch mit nach unten gerichteter Schnittseite gepresst werden.
Limes can be pressed upside down.

Limettenpresse

aus verchromtem Stahl und Kunststoff, 35 mm Stöbel aus schwarzem Polypropylen, speziell zum massenhaften Zubereiten von Caipirinha und Mojito direkt im Glas konzipiert

Lime Press

chrome plated steel with 35 mm black polypropylene muddler, especially for squeezing limes in Caipirinha and Mojito glasses



Art-Nr. Part No.	Länge Length cm	Breite Width cm	Höhe Height cm
808/001	18	13	29

Für marktübliche Caipirinha-Gläser mit maximal 7 cm Bodendurchmesser und 13 cm Höhe
For usual Caipirinha glasses with base diameter up to 7 cm and 13 cm maximum height.

Caipirinha-Stöbel

aus unbehandeltem, naturbelassenen Buchenholz, presst Zitrusfrüchte in Cocktailgläsern leicht aus, ausgeprägte Zahnung für ein optimales Pressergebnis

Muddler

untreated, natural beechwood, easily squeezes citrus fruits into cocktail glasses due to ridged surface



Art-Nr. Part No.	Länge Length
2092/220	22 cm

Caipirinha-Stöbel

aus griffigem schwarzem Polypropylen, spülmaschinengeeignet

Muddler

black polypropylene, dishwasher safe



Art-Nr. Part No.	Länge Length cm	∅ dia. cm
glatter Kopf: / smooth:		
2091/220	22	2,7
radial gezahnt: / serrated:		
2091/222	22,5	2,7
gezahnt: / fine toothed:		
2091/225	22,5	2,7

Rührkappe 'Caipi Cap'®

aus Edelstahl 18/10, daher spülmaschinenfest, hochglänzend poliert, das 'Caipi Cap' wird auf das Glas aufgesetzt und durch die Öffnung kann der Caipirinha oder der Mojito mit einem Löffel gerührt werden, hygienische Alternative zum Auflegen der Hand auf das Glas

Caipirinha Lid

18/10 stainless steel, mirror polished, the 'Caipi Cap'® is a hygienic alternative to handling the Caipirinha or Mojito glass during stirring



Art-Nr. Part No.	∅ außen ∅ Outside cm	∅ Loch ∅ Hole cm	∅ Glas max. ∅ Glass max. cm
5867/085	10	1,8	8,5

'Caipi Cap'® ist eine registrierte Marke der Contacto Bander GmbH.
'Caipi Cap'® is a registered trademark of Contacto Bander GmbH.

Art-Nr. Part No.	Länge Length cm	Breite Width cm	Höhe Height cm
2098/004	24	15	10



Bar-Caddy

aus schwarzem ABS-Kunststoff, mit Fächern für Strohhalme, Utensilien, Dosierflaschen, Cocktail-Servietten 25 x 25 cm 1/4 Falz (12,5 x 12,5 cm)

Bar Caddy

black ABS plastic, stores straws, utensils, bottles, beverage napkins 10"x10" 1/4 folded



Art-Nr. Part No.	Höhe Height cm	Ø innen Ø Inside cm	
2080/100	10	8	0,5 l
2080/140	14	8	0,7 l



Limonadenlöffel-Halter

aus Edelstahl 18/10, außen seidenmatt poliert, innen hochglänzend, mit kleinem offenen Rand, universell einsetzbarer Behälter für Löffel, Trinkhalme, Dressings u.ä., schwere Qualität

Spoon Container

18/10 stainless steel, outside satin polished, inside mirror polished, small open edge, multi purpose for sundae spoons, drinking straws, dressings etc., heavy gauge



Art-Nr. Part No.	Breite Width cm	Höhe Height cm	Ø Glas max. Ø Glass max. cm
2094/140	20	7	14



Salz-/ Zuckerumrander für Cocktailgläser

aus schwarzem ABS-Kunststoff, drei Schalen, davon eine mit Schaumstoffeinlage zum Befeuchten, platzsparend zusammenschiebbar

Cocktail Glass Rimmer

black ABS, three rimmers of which the upper one is used to moisten the glass



Art-Nr. Part No.	Länge Length cm	Breite Width cm	Höhe Height cm	Portionsgröße Portion size
1120/006	50	15,5	9	0,5 l

Zusätzliche lose Einsätze:

Additional spare containers:

6 Einsätze passen in Kasten: / 6 per dispenser:

1120/050	14	7,5	7,5	0,5 l
----------	----	-----	-----	-------

4 Einsätze passen in Kasten: / 4 per dispenser:

1120/075	14	11	7	0,75 l
----------	----	----	---	--------

3 Einsätze passen in Kasten: / 3 per dispenser:

1120/100	14	14,5	7	1 l
----------	----	------	---	-----



Zutatenbehälter

Gehäuse und Deckel aus Polycarbonat, mit 0,5 l-Dosen aus Polypropylen

Condiment Dispenser

polycarbonate frame and lid, with 0.5 L polypropylene containers



Art-Nr. Part No.	Länge Length cm	Breite Width cm
7548/050	30	7,5

{Aufstellung aller aufgeführten Marken auf www.contacto.de.}

{Complete list of brands see www.contacto.co.uk.}



Spirituosenlineal

aus bedrucktem Kunststoff, Schablonen passend zu den 50 gängigsten Spirituosenflaschen, in 2 cl Schritten graduert, schnelles Ablesen des verbliebenen Flascheninhalts

Spirit Bottle Ruler

printed plastic, templates for the most common spirit bottles, graduated each 2 cl, enables quick stock take of remaining bottle contents



Barmaß

aus Edelstahl 18/10, hochglänzend, graduert, schwere Qualität

Cocktail Jigger

18/10 stainless steel, mirror polished, graduated, heavy gauge



Art-Nr. Part No.	Portionsgröße Portion size cl	Höhe Height cm
2090/024	2,0 / 4	7,3
2090/025	2,5 / 5	8,4

Barmaß

aus Edelstahl 18/10, seidenmatt poliert, beide Maße innen graduert, schwere Qualität

Cocktail Jigger

18/10 stainless steel, satin polished finish, graduated inside, heavy gauge



Art-Nr. Part No.	Portionsgröße Portion size cl	Höhe Height cm
1565/050	3 / 5	8,5

Skalierung: alle 10 ccm (=ml)
Graduated every 10 ml

Barmaß

aus klarem Polycarbonat, mit Graduierung bei 2 / 2,5 cl sowie 4 / 5 cl, nahezu unzerbrechlich

Cocktail Jigger

clear polycarbonate, graduated, virtually unbreakable



Art-Nr. Part No.	Portionsgröße Portion size cl	Portionsgröße Portion size cl	Höhe Height cm
2086/024	2 / 2,5	4 / 5	9

Bitterflasche

aus dickem Glas im Art déco Stil, mit Spritzausgießer zur tropfen- oder spritzerweisen Dosierung von Cocktail-Bitter wie Angostura- oder Orangenbitter

Bitters Dash Bottle

heavy gauge glass, with pourer for dashing concentrated bitters such as Angostura bitters into cocktails



Art-Nr. Part No.	Länge Length cm	Breite Width cm	Höhe Height cm	
1478/200	6	5	18,5	0,2 l

Speedbottle

Behälter und Deckel aus Polypropylen, farbige Ausgießer aus SAN-Kunststoff mit 10 mm Ø Ausgussöffnung, Lieferung jeweils im Satz bestehend aus einem weißen Behälter mit buntem, gleichfarbigem Deckel und Ausgießer, zum Lagern, Mixen und Dosieren von Flüssigkeiten

Drinks Mixer Set

polypropylene bottle and lid, SAN (plastic) 10 mm diameter coloured pourer nozzle, set includes a white bottle with lid and pourer of same colour, for storage, mixing, pouring and serving drinks



Art-Nr. Part No.	Höhe Height cm	Ø dia. cm	Farbe Colour
Satz für 1 l Volumen: / 1 L sets:			
5843/101	33,5	9	braun/brown
5843/103	33,5	9	weiß/white
5843/104	33,5	9	gelb/yellow
5843/105	33,5	9	rot/red
5843/106	33,5	9	orange
5843/107	33,5	9	blau/blue
5843/109	33,5	9	grün/green

Satz für 2 l Volumen: / 2 L sets:			
5843/201	35	12,5	braun/brown
5843/203	35	12,5	weiß/white
5843/204	35	12,5	gelb/yellow
5843/205	35	12,5	rot/red
5843/206	35	12,5	orange
5843/207	35	12,5	blau/blue
5843/209	35	12,5	grün/green

Ausgießer auf Anfrage.
Spare pourer nozzles on request.

Art-Nr. Part No.	Länge Length	∅ Durchlauf ∅ Nozzle
---------------------	-----------------	-------------------------

Ohne Kläppchen: / Fast pour:		
367/100	12 cm	8 mm

Mit Kläppchen: / With flap:		
367/101	12 cm	8 mm

gebogenes Rohr: / Goose flow:		
367/102	12 cm	8 mm



Flaschenausgießer

aus Edelstahl, hochglänzend, mit Polypropylen-Pfropfen, mit Entlüftungsrohr, geeignet für alle Flüssigkeiten, für 0,7 bis 1,0 l-Flaschen

Freeflow Pourers

stainless steel, mirror polished finish, with polypropylene cork, with breather tube for smooth flow, for bottles from 0.7 to 1 L



Art-Nr. Part No.	Länge Length cm	∅ dia. cm	∅ Durchlauf ∅ Nozzle mm
---------------------	-----------------------	-----------------	-------------------------------

365/300	11	4	5
---------	----	---	---



Flaschenausgießer, groß

aus Edelstahl, mit Gummi-Pfropfen, für 3 Liter Flaschen mit größeren Flaschenöffnungen von etwa 25-35 mm, mit Entlüftungsrohr

Freeflow Pourer

stainless steel, rubber cork, for 3 litre bottles (with a neck of 25 to 35 mm), with breather tube for smooth flow



Art-Nr. Part No.	Länge Length	∅ Durchlauf ∅ Nozzle
---------------------	-----------------	-------------------------

Ohne Kläppchen: / Fast pour:		
369/090	9 cm	8 mm

Mit Kläppchen: / With flap:		
369/091	9 cm	8 mm



Flaschenausgießer

aus Edelstahl 18/10, hochglänzend, mit Naturkork-Pfropfen geeignet für alle Flüssigkeiten, mit Entlüftungsrohr, für 0,7 bis 1,0 l-Flaschen

Freeflow Pourers

18/10 stainless steel, mirror polished finish, with natural cork and breather tube for smooth flow, for bottles from 0.7 to 1 L



Art-Nr. Part No.	Länge Length cm	∅ Durchlauf ∅ Nozzle mm
---------------------	-----------------------	-------------------------------

5845/080	11	8
----------	----	---



Flaschenausgießer, selbstschließend

aus verchromtem Aluminium, Luftröhre aus Kunststoff, die Klappe hat ein Gegengewicht und öffnet und schließt selbstständig beim Neigen der Flasche

Freeflow Pourer with flap

chrome plated aluminium, plastic breather tube for smooth flow, the lid has a counterweight which opens or closes the flap automatically when pouring



Art-Nr. Part No.	Länge Length	∅ Durchlauf ∅ Nozzle
---------------------	-----------------	-------------------------

5847/001	7,5 cm	6 mm
----------	--------	------



Flaschenausgießer

aus verchromtem SAN-Kunststoff, für 0,75 l bzw. 1 l-Flaschen, nicht geeignet für Anis Schnaps, Dosierung durch Unterbrechung der Luftzufuhr am Belüftungsloch

Freeflow Pourer

medium speed, chrome plated SAN plastic, for 0.75 and 1 L bottles, not suitable for aniseed



Art-Nr. Part No.	Länge Length cm	∅ Durchlauf ∅ Nozzle	Farbe Colour
---------------------	-----------------------	-------------------------	-----------------

5852/001	7	4 mm	schwarz/black
5852/002	7	4 mm	neutral
5852/004	7	4 mm	gelb/yellow
5852/005	7	4 mm	rot/red
5852/007	7	4 mm	blau/blue
5852/009	7	4 mm	grün/green



Flaschenausgießer

aus Polyethylen, passend auf 0,7 und 1,5 l Flaschen, Dosierung durch Unterbrechung der Luftzufuhr am Belüftungsloch

Pourer

polyethylene, suitable for 0.7 L and 1.5 L bottles



Neonfarben: / Neon Colours:

5852/036	7	4 mm	gelb/yellow
5852/038	7	4 mm	orange
5852/039	7	4 mm	pink

Flaschenausgießer

aus Edelstahl 18/10, hochglänzend, mit weichem Silikonpfropfen, geeignet für alle Flüssigkeiten, mit Entlüftungsrohr, für 0,7 bis 1,0 Liter Flaschen

Pourer

18/10 stainless steel, mirror polished finish, silicone cork, with breather tube for smooth flow, for bottles from 0.7 to 1 L



Art-Nr. Part No.	Länge Length	Ø Durchlauf Ø Nozzle
364/110	11 cm	7 mm

Flaschenausgießer für Samtkragen

aus silberfarbenen beschichtetem Messing, spitz auslaufendes konisches Gießrohr, Naturkorken, passend auf 0,7 und 1,5 l Flaschen

Samtkragen Pourer

silver coloured brass, natural cork, matches 0.7 L and 1.5 L bottles, "Samtkragen" is a special West German drink



Art-Nr. Part No.	Länge Length
	cm

PRODUKTION
EINGESTELLT
PRODUCTION
DISCONTINUED

Flaschenausgießer, aufschraubbar

aus Edelstahl, konisch zulaufendes Gießrohr, mit Kläppchen, zum Aufschrauben auf Flaschengewinde

Pourer

stainless steel, with metal cap, screw fitting



Art-Nr. Part No.	Länge Length	Ø dia.
	cm	cm
5854/028	9	2,8
5854/032	9	3,2

Spritzausgießer

zum Dosieren von Spritzern ("Dashes"), Naturkorken mit Kunststoff, Ausgießer verchromt

Dash Pourer

cork with plastic, for pouring tiny portions of liquid, chrome plated pourer



Art-Nr. Part No.	Länge Length	Ø Durchlauf Ø Nozzle
5859/050	5,5 cm	2 mm

Ausgießerbürste

verzinkter Stahldraht, Besatz aus weißem Polyamid, mit Öse, geeignet zur Reinigung von Flaschenausgießern und Schläuchen

Pourer Brush

nickel plated wire steel, white polyamide bristles, with hanging loop, for cleaning pourers and tubes



Art-Nr. Part No.	Länge gesamt Total Length	Ø dia.	Besatzlänge Brush Head
	cm		cm
5886/060	30	6 mm	10
5886/080	30	8 mm	10
5886/085	55	9 mm	4,5

Flaschenausgießer, portionierend

aus Polystyrol, dosierbar durch Kugelventil, für 0,75 l bzw. 1 l -Flaschen, nicht geeignet für Anis Schnaps

Measure Pourers

polystyrene, with black collar, for 0.75 and 1 L bottles, not suitable for aniseed, not UK Government stamped



Art-Nr. Part No.	Portionsgröße Portion size	Ø Durchlauf Ø Nozzle	Länge Length
		mm	cm
Klar: / Clear:			
5844/021	2 cl	6	10
5844/040	4 cl	6	10

Flaschenausgießer, portionierend

dosiert Spirituosen in Zeitintervallen ohne die Flasche Heben und Senken zu müssen

Automatic Pourer

not UK government stamped



Art-Nr. Part No.	Portionsgröße Portion size	Länge Length	Farbe Colour
		cm	
5853/021	2 cl	14,5	schwarz/black



Art-Nr. Part No.	Länge Length cm	Ø dia. cm
2093/280	28	2



Barlöffel mit Stößel

aus Edelstahl, extra schwere Qualität

Cocktail Spoon

with sugar crusher, stainless steel, extra heavy gauge



Art-Nr. Part No.	Länge Length cm
2084/245	24,5



Barlöffel mit Gabel

japanischer Typ, aus Edelstahl

Cocktail Spoon

Japanese type, stainless steel



Art-Nr. Part No.	Länge Length cm
267/280	28 cm



Barlöffel

aus Edelstahl, hochglänzend, mit gedrehtem Stiel

Cocktail Spoon

stainless steel, mirror polished finish



Art-Nr. Part No.	Länge Length cm
2083/280	28,5



Barlöffel

aus Edelstahl

Cocktail Spoon

stainless steel



Art-Nr. Part No.	Länge Length cm
2089/230	23



Cocktailgabel

aus Edelstahl 18/10

Cocktail Fork

18/10 stainless steel



Art-Nr. Part No.	Länge Length cm
265/195	19 cm



Trinkhalmöffel

aus Edelstahl 18/10, hochglänzend, Löffel und Trinkhalm zugleich

Drinks Spoon

18/10 stainless steel, mirror polished finish, spoon and drinking straw combined



Limonadenlöffel

Besteckserie LUNA aus Edelstahl 18/10, hochglänzend

Sundae Spoon

18/10 stainless steel, mirror polished finish



Art-Nr.	Länge
Part No.	Length
1777/072	19,5 cm

Preis je Stück. Besteck wird nur dutzendweise abgegeben.
Priced each. Only available in dozens.

Limonadenlöffel

Besteckserie LOUISA aus Edelstahl 18/10, hochglänzend

Sundae Spoon

18/10 stainless steel, mirror polished finish



Art-Nr.	Länge
Part No.	Length
1999/072	22 cm

Preis je Stück. Besteck wird nur dutzendweise abgegeben.
Priced each. Only available in dozens.

Limonadenlöffel

Besteckserie ATLANTIC aus Edelstahl 18/0

Sundae Spoon

18/0 stainless steel



Art-Nr.	Länge
Part No.	Length
1188/072	19,5 cm

Preis je Stück. Besteck wird nur dutzendweise abgegeben.
Priced each. Only available in dozens.

Limonadenlöffel

Besteckserie EVENT aus Edelstahl 18/0

Sundae Spoon

18/0 stainless steel



Art-Nr.	Länge
Part No.	Length
1133/072	19,5 cm

Preis je Stück. Besteck wird nur dutzendweise abgegeben.
Priced each. Only available in dozens.

Limonadenlöffel

Besteckserie CAMPUS aus Edelstahl 18/0

Sundae Spoon

18/0 stainless steel



Art-Nr.	Länge
Part No.	Length
1122/072	19,5 cm

Preis je Stück. Besteck wird nur dutzendweise abgegeben.
Priced each. Only available in dozens.

Limonadenlöffel

Besteckserie ISABELLA aus Edelstahl 18/0

Sundae Spoon

18/0 stainless steel



Art-Nr.	Länge
Part No.	Length
404/072	18 cm

Preis je Stück. Besteck wird nur dutzendweise abgegeben.
Priced each. Only available in dozens.

Art-Nr. Part No.	Breite Width	Höhe Height
---------------------	-----------------	----------------

PRODUKTION
EINGESTELLT
PRODUCTION
DISCONTINUED



Flaschenhalterung für Wandmontage

aus Aluminium, für 0,75 l bzw. 1 l -Flaschen,
Höhe verstellbar von 32-45 cm

Wall Bracket

aluminium, for 0.7 to 1 L bottles, adjustable
between 32-45 cm

ALU
ALUMINIUM

Art-Nr. Part No.	Höhe Height	∅ innen ∅ Inside
---------------------	----------------	---------------------

PRODUKTION
EINGESTELLT
PRODUCTION
DISCONTINUED



Flaschenhalterung für Wandmontage

für große Flaschen, für die Wandmontage, ganz aus
Aluminium, für 2 bis 3 l-Flaschen, offener Ring

Wall Bracket

for large bottles, aluminium, for 2 L to 3 L bottles

ALU
ALUMINIUM

Art-Nr. Part No.	Breite Width	Höhe Height
---------------------	-----------------	----------------

PRODUKTION
EINGESTELLT
PRODUCTION
DISCONTINUED



Flaschenhalterung für Thekenmontage

aus Aluminium, für 0,75 l bzw. 1 l -Flaschen,
Höhe verstellbar von 32-45 cm

Shelf Bracket

aluminium, for 0.7 to 1 L bottles, adjustable
between 32-45 cm

ALU
ALUMINIUM

Art-Nr. Part No.	∅ dia.	Länge Length
	cm	cm
344/020	2 cl	5,5
344/040	4 cl	5,5



Spirituosen-Dosierer

aus schwarzem Kunststoff, Pfropfen in drei Größen
auswechselbar (siehe Art. 349), Lieferung mit
Standardpfropfen für 0,75 l bzw. 1 l-Flaschen,
nicht geeignet für Anisschnaps, nicht zerlegbar

Spirit Measure

black plastic, with standard cork, 3 sizes of
interchangeable corks, for 0.7 to 1 L bottles,
not suitable for aniseed, not UK Government stamped,
cannot be taken apart

Art-Nr. Part No.	∅ dia.	Länge Length
	cm	cm
345/020	2 cl	5,5
		16



Spirituosen-Dosierer

mit Zählwerk, für 0,75 l bzw. 1 l-Flaschen,
nicht zerlegbar

Spirit Measure

with counter, for 0.75 to 1 L bottles, matches brackets
341, 342, not UK Government stamped, cannot be taken
apart

Art-Nr. Part No.	Länge Length	∅ max.
für 0,75 l-Flaschen: / for 0.75 L bottles:		
349/075	3,2 cm	2,7 cm
für 3 l-Flaschen: / for 3 L bottles:		
349/300	3,8 cm	3,4 cm
für 4 l-Flaschen: / for 4 L bottles:		
349/400	4 cm	3,4 cm



Wechselfropfen

aus schwarzem Spezialkunststoff, in drei Größen,
für Spirituosen-Dosierer 344

Cork

special black plastic, matches spirit measures 344

Barmatte

aus schwarzem lebensmittelgeeignetem Gummi, Abstellflächen mit langen Noppen, spülmaschinengeeignet

Bar Mat

food safe black rubber, dishwasher safe



Art-Nr. Part No.	Länge Length cm	Breite Width cm	Höhe Height cm
370/450	45	30	1

Die schmale Matte hat eine separate Fläche mit kurzen Noppen 8 x 8 cm für Flaschen: /

The small mat has a separate area of 8 x 8 cm for bottles:

370/770	77	9	1,5
---------	----	---	-----

Barmatte, Rollenware

aus weichem, transparenten EVA-Kunststoff, vermeidet Glasbruch beim Absetzen und beschleunigt den Trockenvorgang waschbar bei +40°C pflegeleicht, zuschneidbar

Bar Mat

soft transparent EVA plastic, reduces glass breakages, speeds up the drying process, can be washed at +40°C, can be cut to measure



Art-Nr. Part No.	Breite Width cm	Länge Length cm
5839/500	61 cm	5 m

Gläserabtropfmatte

aus schwarzem Polyvinylchlorid (PVC), aneinander steckbar

Bar Mat

black PVC, interlockable



Art-Nr. Part No.	Größe Size cm
5868/033	33 x 33

Gläserabtropfmatte

aus starrem Polyethylen, 2 x 2 cm Maschenweite, beliebig aneinander steckbar, 4 mm Bodenabstand ermöglicht das ungehinderte Ablaufen des Tropfwassers

Bar Mats

polyethylene, 2 x 2 cm mesh size, can be fitted together



Art-Nr. Part No.	Länge Length cm	Breite Width cm	Höhe Height cm
---------------------	-----------------------	-----------------------	----------------------

PRODUKTION
EINGESTELLT
PRODUCTION
DISCONTINUED

Barregal

aus Edelstahl, zur Wandmontage, Getränkeflaschen sind so schnell erreichbar

Bottle Holder

stainless steel, wall fitting



Art-Nr. Part No.	Länge Length cm	Höhe Height cm	Tiefe Depth cm
einreihig, Fachtiefe 9 cm: / single rack, depth 9 cm:			
7551/056	56	15	10
7551/082	82	15	10
7551/107	107	15	10

Montagesatz zum Umrüsten auf Hängелеisten / Adapter set with hanging racks:

7551/901	25	3,5
----------	----	-----



Hotelbedarf

Der erste Eindruck zählt. Wie wohl sich Ihre Hotelgäste fühlen hängt auch vom Erscheinungsbild ab. Mit Ordnung und Organisation punktet Ihr Haus auf ganzer Linie. Mit den Gepäckwägen und dem Rezeptionsbedarf erscheint Ihr Hotel noch einladender.

Hotel

First impressions count. Ensure the little details don't get overlooked. contacto's range of hotel products will keep you on track.

Seite Page
458

Hotelbedarf
Lobby & Room Service

Werben & Leiten

Sie haben tolle Angebote? Dann informieren Sie potenzielle und bestehende Kunden darüber. Präsentieren Sie Ihre Leistungen. Mit Schildern und Tafeln weisen Sie Ihren Kunden den Weg. Fördern Sie Ihren Umsatz mit den vielfältigen Aufstellern von **contacto**.

Signage

Signage is key to good communication. Indoor or outdoor, large or small, there's plenty of choice to from contacto's range.

Seite Page
464

Werben & Leiten
Free Standing & Wall Signage

Seite Page
470

Tisch & Werbung
Menu Holders & Table Signage



Hotelbedarf

Wir heißen Sie herzlich willkommen. Begleiten Sie uns zur Rezeption und auf Ihr Zimmer. Immer dabei: Hotelinterieur von **contacto** für jeden Zweck und Ambiente.

Lobby & Room Service

Our luggage trolleys and rope barriers will help ensure your lobby service runs smoothly with a touch of class.

Kleidertransportwagen

Gestell aus Edelstahl, schwarze 200 mm Luftreifen, roter Textilbelag auf der Transportfläche, mit umlaufender Gummistoßkante

Hotel Luggage Trolley

stainless steel, 200 mm black inflatable wheels, red carpet base, full wrap around bumper



Art-Nr. Part No.	Länge Length cm	Breite Width cm	Höhe Height cm
1649/185	110	61	184

Versand nur per Spedition möglich.
Pallet delivery only.

Hotelgepäckwagen

Gestell aus Edelstahl, schwarze 200 mm Luftreifen, grauer Textilbelag auf Transportfläche, mit umlaufender Gummistoßkante

Hotel Luggage Trolley

stainless steel, 200 mm black inflatable wheels, grey carpet base, full wrap around bumper



Art-Nr. Part No.	Länge Length cm	Breite Width cm	Höhe Height cm
1650/112	110	61	191

Versand nur per Spedition möglich.
Pallet delivery only.

Hotelgepäckwagen

Gestell aus Edelstahl, goldfarben beschichtet, schwarze 200 mm Luftreifen, roter Textilbelag auf Transportfläche, mit umlaufender Gummistoßkante

Hotel Luggage Trolley

stainless steel, gold coloured, 200 mm black inflatable wheels, red carpet base, full wrap around bumper



Art-Nr. Part No.	Länge Length cm	Breite Width cm	Höhe Height cm
1652/115	110	61	191

Versand nur per Spedition möglich.
Pallet delivery only.



Art-Nr. Part No.	Länge Length cm	Breite Width cm	Höhe Height cm
1653/090	110	61	94

Versand nur per Spedition möglich.
Pallet delivery only.



Gepäckwagen

Gestell aus Edelstahl, schwarze 200 mm Luftreifen, grauer Textilbelag auf Transportfläche, mit umlaufender Gummistoßkante

Hotel Luggage Trolley

stainless steel, 200 mm black inflatable wheels, grey carpet base, full wrap around bumper



Art-Nr. Part No.	Fläche Size cm	Höhe Height cm
1658/125	40 x 40	120

Versand nur per Spedition möglich.
Pallet delivery only.



Gepäckkarre

Gestell aus Edelstahl, schwarze 200 mm Luftreifen, grauer Textilbelag

Hotel Luggage Trolley

stainless steel, 200 mm black inflatable wheels, grey carpet base



Art-Nr. Part No.	Größe Size cm	Höhe Height cm	
1655/150	60 x 42,5	87	1 x 150 l
1655/152	60 x 83,5	87	2 x 150 l

1655/815 Ersatz-Wäschesack 150 l / Spare Bag



Wäschesammelwagen

aus grau lackiertem Stahlrohr mit eingehängten schwarzen Säcken aus gewebeverstärktem Kunststoff, platzsparend klappbar auf nur 15 cm, stabile Rollen, davon zwei mit Feststellern

Laundry Trolley

grey coated steel tube frame, black fabric-reinforced plastic bags, folds to only 15 cm, sturdy wheels, two wheels with brakes on two of them



Art-Nr. Part No.	Fläche Size cm	Höhe Height cm	Ablagehöhe Rack height cm
1606/460	62 x 39	68,5	46



Kofferablage

zusammenklappbar, Rahmen aus hochglanzverchromtem Stahlrohr (Ø 2,5 cm), mit robustem schwarzem Band (5 cm breit) aus Polyamid, Abmessung zusammengeklappt: H85 x B62 x T9 cm, Gewicht ca. 2,5 kg, Traglast bis max. 100 kg

Folding Luggage Rack

chrome plated Ø 2.5 cm tube, 5 cm wide black polyamide belt, dimensions when folded: 85 x 62 x 9 cm, weight 2.5 kg, max. load 100 kg



Art-Nr. Part No.	Fläche Size cm	Höhe Height cm
1605/740	49 x 48	74



Tablettablage

zusammenklappbar, Rahmen aus hochglanzverchromtem Stahlrohr (Ø 2,5 cm), mit robustem schwarzem Band (5 cm breit) aus Polyamid, Abmessung zusammengeklappt: H90 x B49 x T7 cm, Gewicht ca. 2,8 kg, Traglast 60 kg

Folding Tray Stand

chrome plated Ø 2.5 cm tube, 5 cm wide black polyamide belt, dimensions when folded: 90 x 49 x 7 cm, weight 2.8 kg, max. load 60 kg



Absperrpfosten

aus Edelstahl, hochglänzend, mit Konus als oberer Abschluss, mit schwerer Bodenplatte (Ø 31 cm), dazu erhältliches Seil mit verchromtem Verschluss, wahlweise mit oder ohne Ummantelung aus Samt

Barrier Post and Ropes

stainless steel, mirror polished finish, conical top, heavy foot (Ø 31 cm), rope with or without velvet coating



Art-Nr. Part No.	Ø dia. cm	Höhe Height cm	Länge Length cm	Farbe Colour
---------------------	-----------------	----------------------	-----------------------	-----------------

1603/001 5 95
Lieferung unmontiert. Preise je Stück; Verpackungseinheit 2 Stück.
Posts priced each, flat packed in pairs.

Absperrseil, samtummantelt: / Velvet covered rope:

1604/151	3	150	schwarz/black
1604/155	3	150	dunkelrot/dark red
1604/250	3	250	dunkelrot/dark red
1604/154	3	150	blau/blue

Absperrseil, gewunden: / Twist rope:

1604/754	3	150	blau/blue
1604/751	3	150	schwarz/black

1604/802 Wandhaken / Wall fixing

Absperrpfosten, goldfarben

goldfarben beschichteter Stahl, mit Kugel als oberer Abschluss, mit schwerer Bodenplatte (Ø 31 cm), dazu erhältliches Seil mit goldfarbenem Verschluss, wahlweise mit oder ohne Ummantelung aus Samt

Barrier Post and Ropes

gold coloured steel post with ball top, mirror polished finish, heavy foot (Ø 31 cm), matches twist and velvet covered ropes with gold coloured fittings



Art-Nr. Part No.	Ø dia. cm	Höhe Height cm	Länge Length cm	Farbe Colour
---------------------	-----------------	----------------------	-----------------------	-----------------

1601/001 5 100
Lieferung unmontiert. Preise je Stück; Verpackungseinheit 2 Stück.
Posts priced each, flat packed in pairs.

Absperrseil, samtummantelt: / Velvet covered rope:

1602/150	3	150	dunkelrot/dark red
1602/151	3	150	schwarz/black

Absperrseil, gewunden: / Twist rope:

1602/757	3	150	gold
----------	---	-----	------

1602/801 Wandhaken / Wall fixing

Absperrpfosten

aus Edelstahl, hochglänzend, mit Kugel als oberer Abschluss, mit schwerer Bodenplatte (Ø 31 cm), dazu erhältliches Seil mit verchromtem Verschluss, wahlweise mit oder ohne Ummantelung aus Samt

Barrier Post

stainless steel, mirror polished finish, with ball top, heavy foot (Ø 31 cm), matches twist and velvet covered ropes



Art-Nr. Part No.	Ø dia. cm	Höhe Height cm
---------------------	-----------------	----------------------

1608/001 8 100
Lieferung unmontiert. Preise je Stück; Verpackungseinheit 2 Stück.
Posts priced each, flat packed in pairs.

1604/802 Wandhaken / Wall fixing

Seile siehe Serie 1603.

For ropes please refer to Barrier 1603.

Gurtabsperpfosten

aus Edelstahl, hochglänzend, mit selbstaufrollendem 2 m langem farbigen Gurtband in Kassette, drei Einhängemöglichkeiten für Endstücke anderer Pfosten, Grundplatte mit Aussparung zum platzsparenden Lagern

Barrier Post

stainless steel, mirror polished finish, heavy foot, 3-way retractable, with 2 m retractable coloured belt, can be attached to 3 other posts, stackable



Art-Nr. Part No.	Ø Base cm	Boden Height cm	Farbe Colour
---------------------	-----------------	-----------------------	-----------------

1600/200 35 95 blau/blue
1600/205 35 95 rot/red
1600/208 35 95 schwarz/black
Lieferung unmontiert. Preise je Stück; Verpackungseinheit 2 Stück.
Posts priced each, flat packed in pairs.

Ersatz-Oberteil mit Zugband: / Spare Top with belt:

1600/800	blau/blue
1600/805	rot/red
1600/808	schwarz/black

Wandhalterung mit 170 cm Gurt: / Wall fixing including 170 cm belt:

1600/920	blau/blue
1600/925	rot/red
1600/928	schwarz/black

Wandhalterung (Kunststoff) ohne Gurt: / Plastic wall fixing without belt:

1600/330



Art-Nr. Part No.	∅ Boden ∅ Base cm	Höhe Height cm	Farbe Colour
1634/001	35	94	schwarz/black



Gurtabsperpfosten, schwarz

aus Edelstahl, schwarz lackiert, mit selbstaufrollendem 2 m langem schwarzen Gurtband in Kassette, drei Einhängemöglichkeiten für Endstücke anderer Pfosten und an Wandhalterung Art. 1600/330

Black Barrier Post

mat black lacquered stainless steel, heavy foot, 3-way retractable, with 2 m retractable black belt, can be attached to 3 other posts or wall bracket 1600/330



Art-Nr. Part No.	DIN A4/A4
1609/004	DIN A4/A4



Schild auf Gurtabsperpfosten

aus Edelstahl, zum einfachen Aufstecken auf Absperrpfosten mit Zugband Serie Art. 1600 und 1634, DIN A4-Blätter können in den Rahmen zwischen zwei Acryl-Scheiben eingeschoben werden, beidseitig lesbar

Barrier Post Sign

stainless steel, fits retractable barrier post part no. 1600 and 1634, two acrylic windows for A4 signs, visible front and back



Art-Nr. Part No.	∅ oben ∅ Top cm	∅ unten ∅ Base cm	Höhe Height cm
aus Edelstahl: / stainless steel			
1610/730	38	25	73
Schwarz lackierter Stahl: / Black lacquered steel:			
1610/731	38	25	73

Lieferung montiert.
Supplied assembled.



Schirmständer

für 4 Schirme, mit Abtropfschale, tragbar, schwere Qualität

Umbrella Stand

takes 4 umbrellas, with drip tray, portable, heavy gauge

Art-Nr. Part No.	Länge Length cm	Breite Width cm
4351/160	16	2,3 - 4,5
4351/310	30,5	2,5 - 4,8
4351/580	58	2,5 - 4,8



Schuhlöffel

aus grau pulverbeschichtetem Stahl, mit Aufhängeöse, sehr stabile Qualität

Shoe Horn

grey powder-coated steel, with hole for hanging, heavy gauge



Zeitungsablage

zur Wandmontage, aus 6 mm starkem verchromtem Stahldraht, mit vier Ablagen für Illustrierte, Zeitschriften oder Zeitungen, mit zwei seitlichen Montageösen

Newspaper Rack

wall fitting, 6 mm chrome plated steel wire, 4 racks for magazines or newspapers



Art-Nr. Part No.	Breite Width cm	Höhe Height cm
7534/450	26	45
Lieferung ohne Montagematerial Supplied without screws		

Zeitungsstock

aus klar lackiertem Buchenholz, mit patentiertem Federmechanismus für alle Zeitungsgrößen und -stärken, hochwertige Ausführung

Newspaper Holder

lacquered beechwood, with patented spring mechanism to hold all sizes of newspapers and magazines as well as menu cards, high quality



Art-Nr. Part No.	Breite Width cm	Länge gesamt Total Length cm
7522/001	2,2 cm	66 cm

Tischglocke

aus Edelstahl 18/10, hochglänzend

Bell

18/10 stainless steel, mirror polished finish



Art-Nr. Part No.	∅ dia.	Höhe Height cm
1042/009	5 cm	9 cm

Rezeptionsklingel

hochglanzverchromt, mit schwarz lackiertem Metallfuß

Bell

chrome plated, with black lacquered steel foot



Art-Nr. Part No.	∅ Boden ∅ Base cm	Höhe Height cm
1047/001	8,5 cm	6 cm

Rezeptionsklingel

mit lackiertem Holzfuß

Bell

with lacquered wooden foot



Art-Nr. Part No.	∅ Boden ∅ Base cm	Höhe Height cm
1048/001	9 cm	6,5 cm
Verchromt: / Chrome plated:		
1048/002	9 cm	6,5 cm
Messing beschichtet: / Brass plated:		



Art-Nr. Part No.	Breite Width	Höhe Height
silberfarben: / silver coloured :		
7653/910	3 cm	10 cm
Goldfarben: / gold-coloured:		
7653/920	3 cm	10 cm

7653/901 Ersatz-Schonring / Spare rubber ring

Bitte bei der Bestellung die gewünschten Ziffern angeben.
Please mention the numbers along with your order.



Hotelschlüsselanhänger

aus eloxiertem Leichtmetall, mit schwarz ausgelegter Gravur, mit S-Haken und Schonring, alle Nummern bis maximal drei Ziffern erhältlich, Lieferung einseitig graviert, auf Anfrage auch beidseitig beschriftet oder beispielsweise mit Hotelnamen lieferbar

Room Key Fob

anodised aluminium, one side with black engraved numbers, with black rubber door protector, any number (max. 3 digits) possible, both sides can be engraved with numbers or hotel name or both on request



Art-Nr. Part No.	Breite Width	Höhe Height
Silberfarben: / silver-coloured:		
7655/810	3 cm	11,5 cm
Goldfarben: / gold-coloured:		
7655/820	3 cm	11,5 cm

7655/901 Ersatz-Schonring / Spare rubber ring

Bitte bei der Bestellung die gewünschten Ziffern angeben.
Please mention the numbers along with your order.



Hotelschlüsselanhänger

klassische Form, aus eloxiertem Leichtmetall, mit schwarz ausgelegter Gravur, mit S-Haken und Schonring, bis maximal drei Ziffern alle Nummern erhältlich, Lieferung einseitig graviert, auf Anfrage auch beidseitig beschriftet oder beispielsweise mit Hotelnamen lieferbar

Room Key Fobs

anodised aluminium, one side with black engraved numbers, with black rubber door protector, any number (max. 3 digits) possible, both sides can be engraved with numbers or hotel name or both on request



Art-Nr. Part No.	Länge Length
Schöpfkelle: / Soup Ladle:	
7654/001	9 cm
Schaumlöffel: / Skimmer:	
7654/002	8,5 cm
Bratenwender: / Turner:	
7654/003	8 cm
Schneebeesen: / Whisk:	
7654/004	8 cm

(Längen gemessen ohne Kette und Ring)
(Length excludes chain and ring)



Schlüsselanhänger

aus Edelstahl 18/10, hochglänzend, mit Kette und Schlüsselring, hochqualitative Ausführung, Beschriftung auf Anfrage, (außer /004, da dieser aus vernickeltem Stahldraht ohne Kette gefertigt ist)

Key Rings

18/10 stainless steel, mirror polished, with chain and key-ring, etching possible on request (except / 004 chrome plated steel wire whisk)



Art-Nr. Part No.	Höhe Height	Breite Width	Ø Loch Ø Hole
	cm	cm	cm
7662/002	19	8	6 - 8



Türschild "Bitte nicht stören !"

auf starker reißfester 200g/qm Polypropylen-Folie, doppelseitig rot und grün bedruckt, viersprachig (deutsch, englisch, französisch und italienisch)

"Do not disturb" Room Sign

strong 200 g/sqm polypropylene foil, double sided printed in red and green, in four languages (German, English, French, and Italian)



Art-Nr. Part No.	Länge Length	Breite Width
	cm	cm
4347/610	61	8

Preis und Verpackung à 500 Stück.
Priced and packed per pack of 500.



WC Sitzstreifen

aus gestrichenem Papier, viersprachig bedruckt "Diese Toilette ist desinfiziert", wird nach erfolgter Reinigung über den Sitz gelegt

Toilet Seat Cover

coated paper, printed in four languages "This toilet is disinfected", to be placed over the seat after cleaning

Werben & Leiten

Ihre Gäste wollen umworben sein. Machen Sie auf Ihr Unternehmen, Ihre Dienstleistungen und Angebote aufmerksam. Mit den Werbeträgern von **contacto** erfahren Sie die richtige Unterstützung.

Free Standing & Wall Signage

Keep people informed, whether concerning menus, specials or events, using our large range of boards and signs.

Kundenstopper

in DIN-Plakatformaten, wetterfestes 32 mm eloxiertes Aluminiumprofil, mit beidseitigem Klapprahmen, verzinkter Stahlrückwand, verstärkte Ecken, Antireflex-Schutzfolie und Wasserablaufstanzungen

Outdoor Notice Board

32 mm thick aluminium frame, zinc plated steel sheet, non-reflective cover, reinforced corners, weatherproof, holes for rain to drain away



Art-Nr. Part No.		Fläche Size cm	Höhe Height cm
7692/002	DIN A2/A2	42 x 59,4	95
7692/001	DIN A1/A1	59,4 x 84,1	110

Ersatzfolie: / Spare plastic cover:

7692/902	DIN A2/A2
7692/901	DIN A1/A1

Prospektkorb auf Anfrage.
Wire basket on request.

Kundenstopper mit Kreidetafel

aus dreifach lackiertem Kautschukbaumholz, mit Tafel aus schwarzem PVC Kunststoff, Scharniere aus Edelstahl, mit wasserlöslichem Stift beschreibbar, leicht zu reinigen, wetterfest, schwere Qualität

Sandwich Board

triple varnished rubber wood, black PVC board, stainless steel hinges, suitable for water based marker pens, easy to clean, weatherproof, heavy gauge



Art-Nr. Part No.	Fläche Size cm	Breite Width cm	Höhe Height cm
naturfarben / natural			
7695/080	47,5 x 67	55	85
7695/121*	58 x 100	71	140
mahagonifارben / mahogany			
7695/082	47,5 x 67	55	85
7695/122*	58 x 100	71	140
dunkelbraun / dark brown			
7695/124*	58 x 100	71	125
teakfarben / teak			
7695/083	47,5 x 67	55	85
7695/123*	58 x 100	71	125

*Versand dieser Größen nur per Spedition möglich.

*For these sizes pallet delivery only.

Tafelmarker finden Sie auf Seite 473.
Water based marker pens see page 473.

Kundenstopper mit Kreidetafel

aus lackiertem Kiefernholz, mit Tafel aus schwarzem PVC Kunststoff, wetterfest, mit wasserlöslichem Stift beschreibbar, leicht zu reinigen, mittelschwere Qualität

Sandwich Board

varnished pine wood, black PVC board, weatherproof, suitable for water based marker pens, easy to clean, medium gauge



Art-Nr. Part No.	Fläche Size cm	Breite Width cm	Höhe Height cm
schwarz: / black			
7696/085	47 x 67	55	85
7696/125*	58 x 88	68	120
mahagonifارben / mahogany			
7696/122*	58 x 88	68	120
teakfarben / teak			
7696/123*	58 x 88	68	120

*Versand dieser Größen nur per Spedition möglich.

*For these sizes pallet delivery only.

Tafelmarker finden Sie auf Seite 473.
Water based marker pens see page 473.

Art-Nr. Part No.	Länge Length cm	Breite Width cm
7682/060	56,5	47
7682/080*	76,5	56,5
7682/090*	87	67
7682/100*	96,5	76,5

* paßt auf Staffelei 7691.
* fit easel 7691.
Tafelmarker finden Sie auf Seite 473.
Water based marker pens see page 473.



Wandkreidetafel, mahagonifarben

aus schwarzem PVC Kunststoff, Rahmen aus dreifach mahagonifarben lackiertem Buchenholz, wetterfest, mit wasserlöslichem Stift beschreibbar, Tafel und Rahmen sind einfach zu reinigen, geeignet zur Wandmontage oder für Staffelei, schwere hochwertige Qualität

Menu Board, mahogany

black PVC, triple layer mahogany varnished beech wood frame, suitable for water based marker pens, easy to clean, suitable for wall fitting or for easel, weather proof, heavy gauge



Art-Nr. Part No.	Länge Length cm	Breite Width cm
7683/080*	76,5	56,5
7683/090*	87	67
7683/120	120	56

* paßt auf Staffelei 7691.
* fit easel 7691.
Tafelmarker finden Sie auf Seite 473.
Water based marker pens see page 473.



Wandkreidetafel, teakfarben

aus schwarzem PVC Kunststoff, Rahmen aus dreifach teakfarben lackiertem Buchenholz, wetterfest, mit wasserlöslichem Stift beschreibbar, Tafel und Rahmen sind einfach zu reinigen, geeignet zur Wandmontage oder für Staffelei, schwere hochwertige Qualität

Menu Board, teak

black PVC, triple layer teak varnished beech wood frame, suitable for water based marker pens, easy to clean, suitable for wall fitting or for easel, weather proof, heavy gauge



Art-Nr. Part No.	Länge Length cm	Breite Width cm
7684/080*	76,5	56,5
7684/090*	87	67
7684/120	120	56

* paßt auf Staffelei 7691.
* fit easel 7691.
Tafelmarker finden Sie auf Seite 473.
Water based marker pens see page 473.



Wandkreidetafel, dunkelbraun

aus schwarzem PVC Kunststoff, Rahmen aus dreifach dunkelbraun lackiertem Buchenholz, wetterfest, mit wasserlöslichem Stift beschreibbar, Tafel und Rahmen sind einfach zu reinigen, geeignet zur Wandmontage oder für Staffelei, schwere hochwertige Qualität

Menu Board, dark brown

black PVC, triple layer dark brown varnished beech wood frame, suitable for water based marker pens, easy to clean, suitable for wall fitting or for easel, weather proof, heavy gauge



Art-Nr. Part No.	Länge Length cm	Breite Width cm
7680/040	40	30
7680/060	60	40
7680/080*	80	60

* paßt auf Staffelei 7691.
* fit easel 7691.
Tafelmarker finden Sie auf Seite 473.
Water based marker pens see page 473.



Wandkreidetafel, schwarz

aus schwarzem PVC Kunststoff, Rahmen aus schwarz lackiertem Buchenholz, wetterfest, mit wasserlöslichem Stift beschreibbar, Tafel und Rahmen sind einfach zu reinigen, geeignet zur Wandmontage oder für Staffelei, mittelschwere Qualität

Menu Board, black

black PVC, black lacquered beech wood frame, suitable for water based marker pens, easy to clean, suitable for wall fitting or for easel, weather proof, medium gauge



Staffelei

aus dreifach lackiertem Buchenholz, wetterfest, mit Kette oder über Gelenk arretierbar, verstellbare Ablagehöhe für separat zu bestellende Tafeln, schwere Qualität

Easel

triple varnished beech wood, weather proof, adjustable height for different board sizes, heavy gauge



Art-Nr. Part No.	Breite Width cm	Höhe Height cm	Farbe Colour
---------------------	-----------------------	----------------------	-----------------

Ausführungen mit Kette: / with chain:			
7691/161	60	165	natur/natural
7691/162	60	165	mahagoni/mahogany
7691/165	60	165	schwarz/black
Ausführung mit Gelenk: / with support:			
7691/163	75	165	teak

Passende Tafeln 7680-7684 bis 100 cm Höhe bitte separat bestellen.
Please order matching boards 7680-7684 up to 100 cm height separately.

Preistafel

Aufdruck "Heute empfehlen wir" aus 2 mm Polystyrol, Rückseite schwarze Fläche in 10 cm Abständen liniert, mit wasserlöslichem Stift beschreibbar

Specials Menu Board

printed in German "Heute empfehlen wir", plain black rear with lines every 10 cm, suitable for water based marker pens,



Art-Nr. Part No.	Höhe Height cm	Breite Width cm
7688/750	75	50

Tafelmarker finden Sie auf Seite 473.
Water based marker pens see page 473.

Weintafel, groß

in Weinflaschenform, aus schwarzem Polyethylen, mit wasserlöslichem Stift beschreibbar

Menu Board

floor standing or wall mounted, bottle shaped, black polyethylene, suitable for water based marker pens,



Art-Nr. Part No.	Höhe Height cm	Breite Width cm	Tiefe Depth cm
7687/105	105	35	

25 mm starker Kunststofffuß (25 x 35cm) bitte separat bestellen:
/ Please order 25 mm thick plastic base (25 x 35 cm) separately:
7687/905 35 25

Tafelmarker finden Sie auf Seite 473.
Water based marker pens see page 473.

Art-Nr. Part No.	Höhe Height cm	Breite Width cm
Blume / Flower		
7690/001	43	30
Flasche / Bottle		
7690/002	50	19,5
Weinglas / Wine Glass		
7690/004	50	24

Lieferung mit 4 Klebepunkten und einem weißen Kreidemarker.
Supplied with 4 adhesive stickers and a white marker pen.

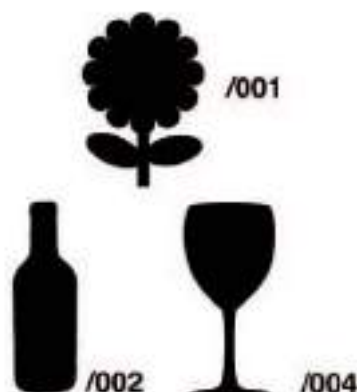

Motiv-Wandtafel

Tafel aus schwarzem PVC Kunststoff, mit wasserlöslichem Stift beschreibbar, leicht zu reinigen

Motif Board

black PVC, suitable for water based marker pens, easy to clean



Art-Nr. Part No.	Länge Length cm	Breite Width cm	Höhe gesamt Overall Height cm
7647/444	40	50	140

Versand nur per Spedition möglich.
Pallet delivery only.



LED Speisekarten Display

Schaukasten aus schwarzem pulverlackbeschichtetem Stahl, für vier A4 Seiten, Glasabdeckung, LED beleuchtet, Anschluss mit 5 m Stromkabel, Akku auf Anfrage erhältlich

Menu Board

from black powder coated steel, takes four A4 pages, behind LED lit glass, includes 5 m electric cable, can also operate with batteries (not included)



Art-Nr. Part No.	Breite Width cm	Höhe Height cm	
7668/004	24	33	DIN A4/A4
7668/003	34	46	DIN A3/A3
7668/002	46,4	63,8	DIN A2/A2
7668/001	64	88	DIN A1/A1

Ersatzfolie: / Spare plastic cover:

7692/904	DIN A4/A4
7692/903	DIN A3/A3
7692/902	DIN A2/A2
7692/901	DIN A1/A1



Wechselrahmen für Wandmontage

in DIN-Plakatformaten, eloxiertes Aluminiumprofil, hochglänzend verchromte Ecken, mit Klapprahmen, Rückwand aus Polystyrol, Antireflex-Schutzfolie, nur für Innenräume geeignet

Menu / Notice Board

anodised aluminium frame, with shiny corners that can be taken apart, polystyrene back, non-reflective cover, indoor use only



Türklinken-Schild

aus 1 mm starkem Edelstahl 18/10, seidenmatt poliert, an Kette, Text "OPEN" und rückseitig "CLOSED" aus schwarzem Siebdruck

OPEN / CLOSED Sign

1 mm thick 18/10 stainless steel, satin polished finish, with chain, black silk screen printed "OPEN" and "CLOSED"

18/10
EDELSTAHL
STAINLESS STEEL



Art-Nr. Part No.	Ø dia.
7659/131	13 cm

Toiletten-Türsymbole

aus 1 mm starkem Edelstahl 18/10, seidenmatt poliert, 7,5 cm Durchmesser, Text aus schwarzem Siebdruck, selbstklebende Rückseite

Toilet Door Signs

1 mm thick 18/10 stainless steel, satin polished finish, 7,5 cm diameter, with self adhesive backing for easy fixing, black silk screen printed

18/10
EDELSTAHL
STAINLESS STEEL



Art-Nr. Part No.	
7661/001	WC
7661/002	Dame / Herr/Ladies/ Gents
7661/003	Dame/Ladies
7661/004	Herr/Gents
7661/005	Rollstuhl/Disabled
7661/006	Bitte setzen/Please sit

Hinweis-Türsymbole

aus 1 mm starkem Edelstahl 18/10, seidenmatt poliert, 7,5 cm Durchmesser, Text aus schwarzem Siebdruck, selbstklebende Rückseite

Door Signs

1 mm thick 18/10 stainless steel, satin polished finish, 7,5 cm diameter, with self adhesive backing for easy fixing, black silk screen printed

18/10
EDELSTAHL
STAINLESS STEEL



Art-Nr. Part No.	
7663/001	Nicht rauchen/No Smoking
7663/002	Handy verboten/No Mobiles
7663/003	Richtungspfeil/This way
7663/004	Garderobe/Coats
7663/005	Kein Zutritt
7663/006	Drücken
7663/007	Ziehen
7663/011	Raucher/Smoking

Nichtraucherschild

aus 1 mm starkem Edelstahl 18/10, seidenmatt poliert, Text aus schwarzem Siebdruck, selbstklebende Rückseite

No Smoking Sign

1 mm thick 18/10 stainless steel, satin polished, with self adhesive backing for easy fixing, black silk screen printed

18/10
EDELSTAHL
STAINLESS STEEL



Art-Nr. Part No.	Ø dia. cm	
7664/001	16	Nicht rauchen/No Smoking

Art-Nr. Part No.	
7673/001	Toiletten
7673/002	Küche
7673/003	Damen (Wort)
7673/004	Herren (Wort)
7673/005	Zu den Toiletten
7673/006	Notausgang grün
7673/008	Kein Durchgang
7673/009	Ziehen
7673/010	Drücken
7673/012	Dame/Ladies (Symbol)
7673/013	Herr/Gents (Symbol)
7673/016	Vorsicht Stufe
7673/017	Privat
7673/018	Behinderten WC
7673/019	Für Garderobe keine Haftung
7673/020	Zutritt nicht gestattet
7673/021	Richtungspfeil/This way



Schilder

für Tür- und Raumbezeichnungen, selbstklebend, Format 16 x 4 cm, blaue Schrift auf silberfarbenem 0,5 mm starkem Hartplastik, wetter- und wischfest

Signs

for doors and rooms, self-adhesive, 16 x 4 cm, blue letters on silver coloured background, water and weather resistant

Art-Nr. Part No.	Breite Width cm	Höhe Height cm
"Geschäftszeit":		
7670/002	24	18
"Toiletten" mit selbstklebendem Pfeil:		
7670/010	30	11
"Für Garderobe wird nicht gehaftet":		
7670/040	35	12,5



Schilder

aus klarem Acrylglas, silberfarben und schwarz hinterdruckt, mit Aufhängeöse

Clear Acrylic Signs

black/silver text, with hanging loop

{Alle Abbildungen unter www.contacto.de}

Further signs available to order.

Art-Nr. Part No.	Höhe Height cm	Breite Width cm	
7674/033	29,5	21	DIN A4/A4



Jugendschutzgesetz

in der aktuellen Fassung, alle aushangpflichtigen Paragraphen sowie §1 und §2, schwarzer Siebdruck auf 1 mm starker PVC-Kunststoffplatte DIN A4, mit Aufhängehaken

Child Protection Law

in German

Art-Nr. Part No.	∅ dia. cm	
7675/010	10	Handy verboten/No Mobiles
7675/012	10	Nicht rauchen/No Smoking
7675/022	20	Nicht rauchen/No Smoking
7675/013	10	Keine Hunde/No dogs



Verbotsschilder

zweifarbige, auf selbstklebender PVC-Folie

Signs

two coloured, self-adhesive

Art-Nr. Part No.	∅ dia. cm
7658/080	8



Nicht raucherschild

selbstklebend, Folie hochglänzend

No Smoking Sign

self adhesive, high gloss

Tisch & Werbung

Angebote, Tagesgerichte und Getränkeaktionen wollen besonders beworben werden. Mit den verschiedenen Aufstellern, Karten und Tafeln von **contacto** können Sie Ihre Gäste stets aktuell informieren.

Menu Holders & Table Signage

From table numbers and reserved signs to a variety of menu holders, **contacto** has it all.



Tischstaffelei

mehrfach lackierter Buchenholzrahmen, mit Tafel aus schwarzem PVC Kunststoff, mit wasserlöslichem Stift beschreibbar, leicht zu reinigen

Menu Board

varnished beech wood frame, black PVC board, suitable for water based marker pens, easy to clean



Art-Nr. Part No.	Fläche Size cm	Höhe Height cm
naturfarben / natural		
7689/240	13 x 15	24
mahagonifarben / mahogany		
7689/241	13 x 15	24
schwarz / black		
7689/245	13 x 15	24

Preis und Verpackung à 3 Stück.
Packed and priced in 3's.

Tischstaffelei

mehrfach mahagonifarben lackierter Holzrahmen, mit Tafel DIN A4 aus schwarzem PVC Kunststoff, mit wasserlöslichem Stift beschreibbar, leicht zu reinigen

Menu Board

varnished wooden frame, mahogany coloured, A4 black PVC board, suitable for water based marker pens, easy to clean



Art-Nr. Part No.	Fläche Size cm	Höhe Height cm
7678/361	31,5 x 21	36

Tisch-Kreidetafel, drehbar

drehbar um 360°, aus schwarzem PVC Kunststoff, Rahmen aus dunkelbraun lackiertem Holz, wetterfest, mit wasserlöslichem Stift beschreibbar, Tafel und Rahmen sind leicht zu reinigen

Menu Board

revolves 360°, black PVC, dark brown varnished wood frame, suitable for water based marker pens, easy to clean, weather proof



Art-Nr. Part No.	Fläche Size	Breite Width cm	Höhe Height cm
7679/470	DIN A5/A5	47	26

Tischaufsteller Kreidetafel

schwarz, aus Melaminharz, flexibel, doppelseitig beschreibbar, abwischbar

Mini Sandwich Board

black, melamine resin, flexible, double-sided, easy to wipe clean



Art-Nr. Part No.	Höhe Height cm	Breite Width cm
7634/017	8,5	5

Fünf Tafeln und ein weißer Kreidemarker sind im Lieferumfang enthalten.
Includes 5 boards and one white marker.



Art-Nr. Part No.	Höhe Height cm	Breite Width cm		VPE carton qty
7635/005	21	14,8	DIN A5/A5	3
7635/006	14,8	10,5	DIN A6/A6	3
7635/007	10,5	7,4	DIN A7/A7	5
7635/008	5,2	7,4	DIN A8/A8	5

Preis je Verpackungseinheit.
Priced per carton quantity.



Tischaufsteller Kreidetafel

in L- Form, aus schwarzem Acryl, Rückseite glänzend, Vorderseite matt, mit Kreidemarkern u.a. beschreibbar

Menu Board

black acrylic, shiny back, matt front suitable for marker pen use



Art-Nr. Part No.	Fläche Size cm	
naturfarben / natural		
7685/150	15 x 10	DIN A6/A6
7685/210	21 x 15	DIN A5/A5
7685/300	30 x 21	DIN A4/A4

mahagonifarben / mahogany		
7685/151	15 x 10	DIN A6/A6
7685/211	21 x 15	DIN A5/A5
7685/301	30 x 21	DIN A4/A4

schwarz / black		
7685/155	15 x 10	DIN A6/A6
7685/215	21 x 15	DIN A5/A5
7685/305	30 x 21	DIN A4/A4

3 lose Einschubtafeln: / set of 3 loose boards:		
7685/915	15 x 10	DIN A6/A6
7685/921	21 x 15	DIN A5/A5
7685/930	30 x 21	DIN A4/A4

Tafelmarker finden Sie auf Seite 473.
Water based marker pens see page 473.



Tischaufsteller Kreidetafel

aus schwarzem PVC Kunststoff, einzuschieben in Rahmen aus dreifach lackiertem Buchenholz, auch als Kartenhalter nutzbar, mit wasserlöslichem Stift beschreibbar, Tafel und Gestell sind leicht zu reinigen, schwere hochwertige Qualität

Menu Board

black PVC, wooden base, triple layer varnished beech wood, suitable for water based marker pens, easy to clean, heavy gauge



Art-Nr. Part No.	Länge Length cm	Breite Width cm	
7666/006	14,8	10,5	DIN A6/A6
7666/007	10,5	7,4	DIN A7/A7
7666/008	7,4	5,2	DIN A8/A8

Preis und Verpackung à 20 Stück.
Priced and packed in 20's.



Schreibtäfelchen

aus schwarzem 1 mm starkem PVC Kunststoff, zum Einklemmen in Kartenhalter, mit wasserlöslichem Stift beschreibbar und leicht wieder zu reinigen

Cards

1.0 mm thick black PVC, ideal for menu/card holders, suitable for water based marker pens



Art-Nr. Part No.	Länge Length cm	Höhe Height cm	
6770/007	7,4	10,5	DIN A7/A7
6770/100	10	10	

Preis und Verpackung à 10 Stück.
Priced and packed in tens.



Dach-Aufsteller, schwarz

aus schwarzem Kunststoff, Hochformat, beschreibbar mit Kreidemarkern u.a.

Table Sign, black

black plastic



Art-Nr. Part No.	Breite Width cm	Höhe Height cm
6768/121	12	5

Verpackung und Preis à 12 Stück.
Priced and packed in dozens.



Dach-Aufsteller, schwarz

aus dünnem PVC-Kunststoff, flach mit Falzkante, beschreibbar mit Kreidemarkern u.a.

Table Sign

thin PVC plastic, flat with folding edge, roof top shaped



Schreibttafelolie

aus schwarzem PVC-Kunststoff, beschreibbar u.a. mit Kreidemarkern, selbstklebend auf vielen Oberflächen, zuschneidbar

Menu Board

flexible black PVC, suitable for marker pens, self adhesive on many surfaces, can be cut to your own design



Art-Nr. Part No.	Länge Length cm	Breite Width cm
7642/100	100	45

Aufsteller Tafeln

aus schwarzem Melamin, auf lackiertem Holzfuß

Chalk Boards

black melamine plastic, on varnished wooden base



Art-Nr. Part No.	Länge Length cm	Breite Width cm	
7632/004	32,5	21	Schreibttafel/Board
7632/010	24	31	Kanne/Jug
7632/012	22	34	Tasse/Cup
7632/013	24,5	25	Teller/Plate

Lieferung mit einem feinen Kreidemarker.
Supplied with a fine white marker pen.

Buchstabenleiste

4 Leisten aus teakfarbenem oder schwarz lackiertem Kiefernholz wahlweise zur Wandmontage (mit Klettband zu befestigen) oder zum Aufstellen, Papierbuchstaben und -zahlen (4,5 x 3,2 cm) zum Einstecken

Letter and Number Rails

4 pine wood rails for wall mounting or table top use, complete with paper letters and numbers (4.5 x 3.2 cm)



Art-Nr. Part No.	Länge Length cm	Höhe Height cm	Farbe Colour
7636/100	4x 25 cm	6 cm	teak
7636/105	4x 25 cm	6 cm	schwarz/black

Lieferumfang: 4 Leisten, 109 Buchstaben (weiß auf schwarz), 34 Ziffern (schwarz auf weiß), 26 Sonderzeichen (&, +, Komma ...)
Included: 4 bars, 109 letters (white on black), 34 numbers (black on white), 26 special characters (&, +, Comma ...)

Flaschenanhänger

aus Melaminharz, doppelseitige, flexible und abwaschbare Kreidetafelschilder, zur einfachen Beschriftung von Flaschen

Bottle Tag

melamine resin, double-sided, flexible and washable chalkboard labels, for easy labelling of bottles



Art-Nr. Part No.	Länge Length cm	Breite Width cm
7633/160	16	6,5

Preis und Verpackung à 10 Stück.
Priced and packed in tens.



Art-Nr. Part No.	Farbe Colour
7701/020	weiß/white

Passend hierzu unsere Schreiftafeln ab Seite 464
Ideal for use with boards starting on page 464



Kreidemarker, fein rund

2 mm runde Schriftbreite, mit Wasser leicht zu entfernen

Marker Pens

2 mm round tip, water soluble

Art-Nr. Part No.	Farbe Colour
7702/050	weiß/white
7702/052	gelb/yellow
7702/053	blau/blue
7702/056	grün/green
7702/058	orange
7702/059	rot/red
7693/065	pink
7693/066	violett/purple
7693/068	gold
7693/069	silber/silver



Kreidemarker, schmal

2-5 mm Schriftbreite, mit Wasser leicht zu entfernen

Marker Pens

5x2 mm tip, water soluble

Art-Nr. Part No.	Farbe Colour
7703/150	weiß/white
7703/152	gelb/yellow
7703/153	blau/blue
7703/156	grün/green
7703/158	orange
7703/159	rot/red
7694/155	pink
7694/156	violett/purple



Kreidemarker, breit

5-15 mm Schriftbreite, mit Wasser leicht zu entfernen

Marker Pens

15x5 mm tip, water soluble

Art-Nr. Part No.	Länge Length cm	Breite Width cm	Höhe Height cm
7199/125	10,5	6	2,5

Preis und Verpackung à 2 Stück.
Priced and packed in pairs.



Tafelschwamm

aus feinem Melaminschaum, zum Entfernen von Kreideschrift auf Schreiftafeln

Chalk Board Sponge

fine melamine foam, for cleaning boards



Art-Nr. Part No.	0,5 l
7198/050	

Das Spray ist "reizend" gemäß Gefahreinstufung Chemikaliengesetz.
The liquid contents are an irritant according to the hazard classification of the chemicals act.



Tafelreiniger

entfernt Tafelkreide und Marker von glatten Oberflächen

Board Cleaner

removes chalk and marker pen ink from non porous surfaces

Tischnummern

aus 0,8 mm starkem Edelstahl 18/10, seidenmatt poliert, mit Ziffern aus schwarzem Siebdruck, beidseitig bedruckt, Fläche 5,3 x 3,4 cm, Aufdruck ist nicht spülmaschinenfest

Table Numbers

0.8. mm thick 18/10 stainless steel, satin polished finish, black silk screen printed numbers, printed on front and back, 5.3 x 3.4 cm, printing is not dishwasher proof



Art-Nr.	Part No.
1054/612	Nummern 1 bis 12: / Numbers 1 to 12:
1054/624	Nummern 13 bis 24: / Numbers 13 to 24:
1054/636	Nummern 25 bis 36: / Numbers 25 to 36:
1054/648	Nummern 37 bis 48: / Numbers 37 to 48:
1054/660	Nummern 49 bis 60: / Numbers 49 to 60:
1054/672	Nummern 61 bis 72: / Numbers 61 to 72:

Verpackungseinheit mit jeweils zwölf aufeinanderfolgenden Zahlen, keine Einzelabgabe. Weitere Nummern auf Anfrage.
Priced and packed per set of 12 only. Further numbers on request.

Tischnummern

mit ausgestanzten Ziffern, aus 0,9 mm starkem Edelstahl 18/10, hochglänzend poliert, wetterfest, spülmaschinengeeignet, Fläche 7,5 x 5,5 cm, 4,5 cm hoch, * einstellige Nummern 6,5 cm breit, ** dreistellige Nummern 9 cm breit, höhere Nummern auf Anfrage lieferbar, schwere Qualität

Table Numbers

stamped out, 0.9 mm thick 18/10 stainless steel, mirror polished finish, weather proof, dishwasher safe, size 7.5 x 5.5 cm, 4.5 cm vertical height, * single digit width 6.5 cm, ** triple digit 9 cm wide, higher nos on request, heavy gauge



Art-Nr.	Part No.
1059/612*	Nummern 1 bis 12 / Set of Numbers 1 to 12
1059/624	Nummern 13 bis 24 / Set of Numbers 13 to 24
1059/636	Nummern 25 bis 36 / Set of Numbers 25 to 36
1059/648	Nummern 37 bis 48 / Set of Numbers 37 to 48
1059/660	Nummern 49 bis 60 / Set of Numbers 49 to 60
1059/672	Nummern 61 bis 72 / Set of Numbers 61 to 72
1059/684	Nummern 73 bis 84 / Set of Numbers 73 to 84
1059/696	Nummern 85 bis 96 / Set of Numbers 85 to 96

1059/000	Einzelnummern von 1 bis 99 / Single Numbers from 1 to 99
1059/999**	Einzelne dreistellige Nummer (bis 250) / 3-digit numbers (up to 250)

Tischnummern

mit schwarz ausgelegter Gravur, aus eloxiertem Leichtmetall, alle Nummern bis 999 lieferbar, hochqualitative Ausführung

Table Numbers

anodised aluminium, with black engraved numbers, any number (max. 3 digits) possible



Art-Nr.	Breite	Höhe
Part No.	Width	Height
Silberfarbig: / silver:		
1067/510	5 cm	5 cm
Goldfarbig: / gold:		
1067/520	5 cm	5 cm

Anfertigung nach Bedarf. Preis je Stück.
Priced and available per piece.

Buffet-Schild

aus Edelstahl 18/10, hochglänzend poliert, auch mit wasserunlöslichem Stiften zu beschreiben, da mit Lösungsmitteln leicht wieder zu reinigen, spülmaschinenfest

Table Sign

18/10 stainless steel, mirror polished, suitable for all kinds of marker pens, dishwasher safe



Art-Nr.	Ø	Höhe
Part No.	dia.	Height
7230/100	10 cm	6,5 cm



Art-Nr. Part No.	Breite Width	Höhe Height
Text: RESERVIERT		
1056/120	12 cm	5,5 cm
Text: RESERVED		
1056/121	12 cm	5,5 cm



Reserviert-Aufsteller

aus Edelstahl 18/0, seidenmatt gebürstet, schwarze Laserung, schwere Qualität

Reserved Table Sign

18/0 stainless steel, satin polished finish, black laser marking, heavy gauge



Art-Nr. Part No.	Breite Width	Höhe Height
Text: RESERVIERT		
1055/001	6,5 cm	4 cm
Text: RESERVED		
1055/002	6,5 cm	4 cm



Reserviert-Aufsteller

aus Edelstahl 18/10, hochglänzend, mit geprägten Buchstaben, schwere Qualität

Reserved Table Sign

18/10 stainless steel, mirror polished finish, stamped letters, heavy gauge



Art-Nr. Part No.	Breite Width	Höhe Height
6769/120	12 cm	5 cm
Preis je Stück. Priced each.		



Reserviert Aufsteller

aus dünnem PVC-Kunststoff, flach mit Falzkante, Dachform, bedruckt mit goldenen Buchstaben

Reserved Table Sign

thin PVC plastic, flat with folding edge, roof top shaped, gold printed letters



Art-Nr. Part No.	Breite Width	Höhe Height
6783/100	10 cm	5 cm
Einschubkarten à 25 Stück: / Set of 25 cards:		
6783/901	Deutsch: "Reserviert" / German: "Reserviert"	
6783/944	Englisch: "Reserved" / English: "Reserved"	
Einschubkarten blanko à 25 Stück: / Blanco		
6783/725	10 cm	5 cm



Aufsteller, klein

aus Acryl, für Einschubkarte 10 x 5 cm

Card Holder

clear acrylic, for 10 x 5 cm cards



Art-Nr. Part No.	Breite Width	Höhe Height
6784/105	10,5 cm	8 cm



Aufsteller, klein

aus Acryl, für Einschubkarten 10,5 x 8 cm (DIN A7)

Card Holder

clear acrylic, for 10.5 x 8 cm cards (A7)



Kartenhalter

aus Edelstahl 18/0, hochglänzend, mit Schlitz für Karte

Card Holder

18/0 stainless steel, mirror polished finish, with slot for card



Art-Nr. Part No.	Breite Width	Höhe Height
300/060	5 cm	3 cm

Kartenhalter

aus Edelstahl 18/0, hochglänzend, mit Falz für Kärtchen

Card Holder

18/0 stainless steel, mirror polished finish, with fold for card (excludes card)



Art-Nr. Part No.	Breite Width	Höhe Height
für Karten bis zu 5,9 x 3,5 cm: / for 5.9 x 3.5 cm cards max:		
303/035	5,9 cm	2,5 cm

für Karten bis zu 6,2 x 5,0 cm: / for 6.2 x 5.0 cm cards max:		
303/060	6,2 cm	4 cm

Nichtraucher-Aufsteller

aus 1,5 mm starkem Edelstahl 18/10, hochglänzend poliert, passend zu Tischnummernschilder 1059, schwere Qualität

No Smoking Sign

1.5 mm thick 18/10 stainless steel, mirror polished finish, matches 1059 range of table numbers, heavy gauge



Art-Nr. Part No.	Breite Width	Höhe Height
mit beidseitigem farbigem Aufkleber "Nichtraucher" (Ø 3 cm): / with coloured sticker (Ø 3 cm) on both sides:		
1053/001	6,5	4

neutral, ohne Aufkleber: / plain, without sticker:		
1053/701	6,5	4

Ersatzaufkleber auf Anfrage.
 Spare stickers available on request.

Nichtraucher-Aufsteller

aus 0,7 mm starkem Edelstahl 18/10, seidenmatt poliert, passend zu Tischnummernschilder 1054, schwere Qualität

No Smoking Sign

0.7 mm thick 18/10 stainless steel, satin polished, matches 1054 range of table numbers, heavy gauge



Art-Nr. Part No.	Breite Width	Höhe Height
mit beidseitigem farbigem Aufkleber "Nichtraucher" (Ø 3 cm): / with coloured sticker "Non Smoking" (Ø 3 cm) on both sides:		
1053/002	5,3	3,4

neutral, ohne Aufkleber: / plain, without sticker:		
1053/702	5,3	3,4

Ersatzaufkleber auf Anfrage.
 Spare stickers available on request.

Nichtraucher-Aufsteller

aus Edelstahl 18/0, matt gebürstet, beidseitig schwarzer Siebdruck

No Smoking Sign

18/0 stainless steel, matt polished finish, black silk screen printed on both sides



Art-Nr. Part No.	Breite Width	Höhe Height
1066/050	5,2 cm	4,3 cm

Menükartenhalter

aus Edelstahl 18/10, mit schrägem Anstellwinkel, für bis zu 1,8 mm starke Karten, seidenmatt polierte Oberfläche, ideal am Buffet

Menu/ Card Holder

18/10 stainless steel, 1.8 mm slot, satin polished



Art-Nr. Part No.	Größe Size	Höhe Height
	cm	cm

PRODUKTION
 EINGESTELLT
 PRODUCTION
 DISCONTINUED



Art-Nr. Part No.	Größe Size cm	Höhe Height cm
1052/080	8 x 8	2

Passende Kartenhülle aus klarem PVC: / Fits clear PVC menu holder:
1052/921 20 x 12



Kartenhalter

aus Edelstahl 18/0, seidenmatt gebürstet

Menu Holder

18/0 stainless steel, satin brushed finish



Art-Nr. Part No.	Breite Width cm	Höhe Height cm
6771/105	10,5	4



Kartenhalter

aus Acryl, für bis 2 mm starke laminierte Karten

Menu Holder

acrylic, 2 mm slot, for laminated cards



Art-Nr. Part No.	Maß Size mm	Höhe Height cm
1068/110	22 x 22	11
1068/160	22 x 22	16



Kartenhalter in Würfelform

silberfarbener Polyesterharzwürfel mit Stahldraht, Krokodilklemme zum Einklemmen der Karte

Menu/ Card Holder

silver coloured polyresine cube, steel wire with alligator clip for cards



Art-Nr. Part No.	Ø Boden Ø Base cm	Höhe Height cm
313/140	8	10
313/190	8	19
313/290	8	29
313/460	8	46

Lieferung ohne Schreibtafel (Tafeln siehe Seite 471)
Supplied without card/board. (Boards can be found on page 471)



Bankettkartenständer

aus Edelstahl, hochglänzend, schwere Qualität

Menu/ Card Holder

stainless steel, mirror polished finish, heavy gauge



Art-Nr. Part No.	Länge Length cm
1070/100	10

Lieferung ohne Schreibtafel (Tafeln siehe Seite 471)
Supplied without card/board. (Boards can be found on page 471)



Einsteck-Kartenhalter

aus Edelstahl 18/10, zum Einklemmen von Schreibtafeln und Schildern und Einstecken in Lebensmittel

Spiked Card Holder

18/10 stainless steel



Kartenhalter

Edelstahl 18/10, mit Schreibtafel DIN A7 (10,5 x 7,4 cm)
aus schwarzem Polyethylen

Card Holder

18/10 stainless steel, with A7 (10.5 cm x 7.4 cm) black
polyethylene board



Art-Nr. Part No.	Breite Width cm	Höhe Height cm	Tiefe Depth cm
1064/007	4,5	8,5	5,5

Tafelmarker finden Sie auf Seite 473.
Water based marker pens see page 473.

Kartenhalter, magnetisch

aus Acryl, die beiden Acryl-Platten werden durch
Magnete zusammengehalten, dadurch können
selbstgedruckte Karten mühelos eingelegt und
gewechselt werden, universell als Tischnummer,
Speisenbezeichner, Reserviert-Schild, Namensschild
oder für Visitenkarten u.a. nutzbar

Magnetic Card Holder

acrylic, both acrylic plates are held together by
magnets, individually printed cards can be swiftly
inserted or removed, can also be used for table
numbers, buffet sign, reserved sign, name sign, etc.



Art-Nr. Part No.	Breite Width cm	Höhe Height cm	Tiefe Depth cm
6791/080	8,3	5,5	1,5

Aufsteller

aus dickem Acrylglas, passend für Karten
im Hochformat, mit stabilem Standfuß

Menu Holder

acrylic



Art-Nr. Part No.	Breite Width cm	Höhe Height cm	
6781/100	10,2	15,2	DIN A6/A6
6781/150	15	22	DIN A5/A5
6781/210	21	30,5	DIN A4/A4

Tischaufsteller A5, quer

aus Acryl, für Karten bis DIN A5 (210 x 148 mm)

Card Holder A5

acrylic, for cards up to A5 (210 x 148 mm)



Art-Nr. Part No.	Breite Width cm	Höhe Height cm	
6772/210	21	15	DIN A5/A5

Kartenhalterröhre

origineller Aufsteller aus klarem Acryl, innen kann ein
DIN A4 Blatt - bedruckt im Querformat - lose eingelegt
werden, schnell zu wechseln, platzsparend

Tubular Menu/Card Holder

clear acrylic, A4 fits exactly in landscape



Art-Nr. Part No.	∅ dia. cm	Höhe Height cm
6780/004	10	21



Art-Nr. Part No.	Breite Width cm	Höhe Height cm	
6779/004	21	29,7	DIN A4/A4
6779/005	14,8	21	DIN A5/A5
6779/006	10,5	14,8	DIN A6/A6



Thekenaufsteller

aus Acryl, in L-Form

Menu Holder

acrylic



Art-Nr. Part No.	
---------------------	--

5830/242	Kasten mit 20 Mappen (schwarz) / Wooden box of 20 black holders
----------	--

5830/042	Einzelmappe, schwarz (ausgestattet mit 2 Einlegehüllen) / Single Holder, black (supplied with 2 plastic inserts)
----------	---

5830/902	5 St. Einlegehüllen (für je 2 x DIN A4) / 5 sets of plastic inserts (each 2 x A4)
----------	--

Weitere Farben auf Anfrage.
Other colours on request.



Speisekartenmappe

Kasten (35 x 27 x 35 cm) aus mehrfach teakfarben lackiertem Buchenholz, Mappen (32 x 26 cm) aus Polypropylen, für DIN A4 Speisekarten

Menu Holder

teak varnished beech wood spine (35 x 27 x 35 cm), polypropylene cards (32 x 26 cm), for A4 menu cards



Art-Nr. Part No.	Höhe Height cm	Breite Width cm	Farbe Colour
5831/041	34	24	schwarz/black
5831/043	34	24	blau/blue
5831/044	34	24	braun/brown
5831/046	34	24	grün/green
5831/049	34	24	bordeaux

Eine Einlegehülle wird jeweils mitgeliefert.
Supplied with one plastic insert.

5831/241	Kasten mit 20 schwarzen Mappen / box of 20 black holders
----------	---

5831/904	10 St. Einlegehüllen (für je 4 x DIN A4) / 10 sets of plastic inserts (each 4 x A4)
----------	--

Boxen mit 20 Mappen in anderen Farben auf Anfrage erhältlich.
Boxes for 20 cards in other colours on request.



Speisekartenmappe

aus feinem Kunstleder, mit Aufdruck MENU, leicht zu reinigen, langlebig, gut verarbeitet, Einlegehüllen A4 können schnell gewechselt werden

Menu Holder

fine artificial leather, A4, includes one plastic insert, MENU printed on front, easy to clean



Art-Nr. Part No.	Länge Length cm	Breite Width cm	
5832/004	34	24	DIN A4/A4

Eine Einlegehülle wird mitgeliefert.
Supplied with one plastic insert.

5831/904	10 St. Einlegehüllen (für je 4 x DIN A4) / 10 sets of plastic inserts (each 4 x A4)
----------	--



Weinkartenmappe

aus schwarzem Kunstleder, passend zu Speisekarten 5831, leicht zu reinigen, langlebig, gut verarbeitet

Wine List Holder

black artificial leather, matches menu holder 5831, easy to clean



Weinkartenmappe

aus Kunstleder, außen Korkimitat, leicht zu reinigen, langlebig, gut verarbeitet

Wine List Holder

artificial leather, cork effect cover, easy to clean



Art-Nr. Part No.	Länge Length cm	Breite Width cm	
5833/040	34	24	DIN A4/A4
Eine Einlegehülle wird mitgeliefert. Supplied with one plastic insert.			
5831/904	10 St. Einlegehüllen (für je 4 x DIN A4) / 10 sets of plastic inserts (each 4 x A4)		

Speisekarte, einfach

Außenhülle aus PVC in Glattlederoptik, Metallschutzecken, Aufschrift "Menu" in Goldprägdruck, abwaschbar, für maximal zehn DIN A4 Blätter (zwei Blätter in den Innenseiten der Mappe und vier doppelseitig bestückbare Einlegehüllen)

Menu Holder

leather look PVC cover, with metal corners, hand washable, for maximum ten A4 sheets (2 inside the cover and 8 in 4 fixed sleeves)



Art-Nr. Part No.	Höhe Height cm	Breite Width cm	Farbe Colour	
5829/041	31	23,5	schwarz/black	DIN A4/A4
5829/049	31	23,5	bordeaux	DIN A4/A4
5829/051	23,5	16,5	schwarz/black	DIN A5/A5
5829/059	23,5	16,5	bordeaux	DIN A5/A5

Klemmbrett

aus beschichtetem Holz, mit Federklammer aus Edelstahl, feucht abwischbar

Clip Board

wooden look, with stainless steel spring clip, can be wiped with a damp cloth



Art-Nr. Part No.	Länge Length cm	Breite Width cm	
5825/002	26,5	11,5	
5825/004	33	23	DIN A4/A4

Speisekartenstock

aus klar lackiertem Buchenholz, mit Flügelschrauben, geeignet für gelochte Klarsichthüllen DIN A4, hochwertige Ausführung

Menu Card Holder

lacquered beechwood, with wing screws to hold all menu cards, high quality



Art-Nr. Part No.	Breite Width cm	Länge gesamt Total Length cm
7523/001	2	44

Ordnen & Hygiene

Das tägliche Aufräumen und Säubern im Betrieb geht leichter von der Hand, wenn die geeigneten Geräte zum Inventar gehören. Diese helfen Ihnen, Ihre Betriebs- und Arbeitsabläufe zu organisieren und zu optimieren. Der Transport, die Lagerung und das Reinigen aller Geschirre ist eine eigene zentrale Aufgabenstellung und hilft vorgeschriebene Hygienestandards einzuhalten.

Transportation & Cleaning

Ease the burden of kitchen cleaning with the use of appropriate, high-quality utensils and equipment. This category presents all the products you will need to optimise your operational processes to comply with hygiene standards.

Seite Page
482

GastroNorm Thermoboxen
Insulated Boxes



Seite Page
484

GastroNorm Thermoboxen EPP
Insulated EPP Boxes



Seite Page
486

Servierwagen
Trolleys



Seite Page
490

Geschirrorganisation & Reinigen
Crockery Organisation & Cleaning



Seite Page
508

Abfallentsorgung
Waste Disposal



Seite Page
518

Arbeitsschutz
Protective Work Wear





GastroNorm Thermoboxen

Liefere Sie Ihrem Kunden, trotz längerem Anfahrtsweg, die Speisen richtig temperiert an. Diese Boxen sind ein unerlässlicher Helfer für Catering- und Bringdienste. Heißes bleibt länger heiß - Kaltes länger kalt.

Insulated Boxes

Deliver food to your customer at the correct temperature. These boxes are indispensable for catering and delivery services. Hot stays hot; cold stays cold.

Thermoboxen aus Polypropylen sind wegen ihrer Robustheit langlebige Alternativen zu EPP. Die Isolierung aus Polyurethan hält Kälte oder Wärme. Die als Top- oder Frontlader erhältlichen Modelle sind unbeheizt. Sie ermöglichen einen hygienischen und zuverlässigen Transport. Auflageschienen zur Aufnahme und leichten Entnahme von Gastronormbehältern sind integriert. Die Tragegriffe und Drehverschlüsse sind aus bruchfestem Polyamid

Polypropylene thermoboxes are a sturdy alternative to EPP. The polyurethane insulation can be used to keep food hot and cold inside. Available for top- or frontloading without internal heating. Enables hygienic and reliable transport of Gastronorm containers. The handles and locks are made from virtually unbreakable polyamide. These boxes are dishwasher safe and stackable.



- aus gelben Polypropylen
- Isolierung aus Polyurethan
- Griffe aus Polyamid
- Auflageschienen für GN
- stapelbar
- *yellow polypropylene*
- *polyurethane insulation*
- *heavy gauge*
- *polyamide handles*
- *rails for GN containers*
- *stackable*

Thermobox GN 1/2

aus gelbem Polypropylen, isoliert, Frontlader, mit einem Tragegriff an der Oberseite aus bruchfestem Polyamid, Stecktür mit Drehverschluss, mit vier Auflageschienen zur Aufnahme und leichten Entnahme von Gastronorm-Behältern GN 1/2, robust, spülmaschinengeeignet

Insulated GN 1/2 Box

for Gastronorm containers, double walled yellow polypropylene, with one polyamide handle on top and lock on the front door, dishwasher proof, sturdy



Art-Nr. Part No.	Länge außen Outer Length cm	Breite außen Outer Width cm	Höhe außen Outer Height cm	Gewicht Weight kg
3421/050	42,5	34	49,5	6 kg

Lieferung ohne GN-Behälter. Beladbar mit GN 1/2 Behältern in unterschiedlichen Kombinationen, z.B. 4 x GN 1/2 in 65 mm oder 3 x 100 mm oder 2 x 150 mm oder 1 x 200 mit 1 x 150 mm.

Supplied without GN containers. Takes for example: 4 x 1/2 65 mm, 3 x 1/2 100 mm, 2 x 1/2 150 mm or 1 x 1/2 200 plus 1 x 1/2 150 mm GN containers

Thermobox GN 1/1

aus gelbem Polypropylen, Frontlader, mit 12 Auflageschienen mit je 39 mm Abstand, mit beidseitigen Tragegriffen, um 270° schwenk- und abnehmbare Tür mit Spannverschluss, sehr robust, spülmaschinengeeignet, extra verstärkte Ausführung

Insulated GN 1/1 Box

for Gastronorm containers, double walled yellow polypropylene, with 12 shelves 39 mm apart, with two virtually unbreakable polyamide handles, 270° removable hinged door with lock, dishwasher proof, very sturdy, heavy gauge



Art-Nr. Part No.	Länge außen Outer Length cm	Breite außen Outer Width cm	Höhe außen Outer Height cm	Gewicht Weight kg
3425/600	49,5	63,5	63	12

Lieferung ohne GN-Behälter. Beladbar mit GN 1/1 Behältern in unterschiedlichen Kombinationen, z.B. 6 x GN 1/1 in 65 mm oder 4 x 100 mm oder 2 x 200 mm. Versand nur per Spedition möglich.

Supplied without GN containers. Takes for example: 6 x 65 mm, 4 x 100 mm or 2 x 200 mm GN 1/1 containers. Pallet delivery only.

GastroNorm Thermo-Transportbehälter

Gastronorm Boxes



Art-Nr. Part No.	Länge außen Outer Length cm	Breite außen Outer Width cm	Höhe außen Outer Height cm	Gewicht Weight kg
3423/300	62	42	40,5	7,1

Lieferung ohne GN-Behälter und abgebildete Bestecke. Passende Besteckserien Ergonom oder Buffet ONE.
Supplied without GN containers and utensils. Suggested matching utensils ranges: Ergonom and Buffet ONE.



Thermobox GN 1/1

aus gelbem Polypropylen, isoliert, Toplader, mit beidseitigen Tragegriffen und zwei Drehverschlüssen aus bruchfestem Polyamid, Deckel mit Kellenhalterung, durch die integrierte Behälterausparung sind die Behälter leicht zu entnehmen, sehr robust, spülmaschinengeeignet, extra verstärkte Ausführung

Insulated GN 1/1 Box

for Gastronorm containers, double walled yellow polypropylene, with two virtually unbreakable polyamide handles and locks, cutlery compartment on the inside of the lid, dishwasher proof, very sturdy, heavy gauge

Art-Nr. Part No.	Länge Length cm	Breite Width cm	Höhe Height cm
3429/011	53	32,5	4,5



Kühlakku zu Thermobox GN

im GN-Maß 1/1, zum u.a. Einschieben in Thermoboxen

GN 1/1 Ice Pack

fits insulated GN 1/1 thermo boxes



Art-Nr. Part No.	Fläche Size cm	Höhe Height cm
3428/550	55 x 50	17



Rollwagen für Thermoboxen

aus Edelstahl, mit vier Rollen, davon zwei mit Feststellern, passend zu Thermoboxen 3421, 3423, 3425

Castors for Insulated GN Boxes

stainless steel, with 4 wheels, 2 wheels with brakes, matches 3421, 3423 and 3425 boxes



Art-Nr. Part No.	Länge außen Outer Length cm	Breite außen Outer Width cm	Höhe außen Outer Height cm
---------------------	-----------------------------------	-----------------------------------	----------------------------------

PRODUKTION
EINGESTELLT
PRODUCTION
DISCONTINUED



Kühlbox Island Breeze®

aus blauem Kunststoff, mit seitlichen Fallgriffen

Insulated Box

blue PVC, with white lid, folding handles



Art-Nr. Part No.	Länge außen Outer Length cm	Breite außen Outer Width cm	Höhe außen Outer Height cm
---------------------	-----------------------------------	-----------------------------------	----------------------------------

PRODUKTION
EINGESTELLT
PRODUCTION
DISCONTINUED



Kühlbox ISLAND®

aus blauem Kunststoff, seitliche Tragemulden, mit Tragebügel

Insulated Box

blue PVC, swing-up handle, moulded handle



Art-Nr. Part No.	Länge Length cm	Breite Width cm	Gewicht Weight g	VPE carton qty
6208/300	17,5	12,5	300	50
6208/400	17,5	12,5	400	40

Preise je Verpackungseinheit.
Priced per carton quantity.



Kühlbeutel

mit unbedenklichem Kühlmittel, besonders geeignet zum Versand von Lebensmitteln

Ice Pack

with foodsafe gel, especially suitable for food transport



GastroNorm Thermoboxen EPP

Thermoboxen aus dem innovativen Spezialkunststoff EPP sind die perfekten leichten Behälter für den temperaturstabilen Transport von Lebensmitteln.

Insulated EPP Boxes

The lightweight economical alternative for transporting food safely.



- leicht
- stabil
- integrierte Handgriffe
- gute Isolierwirkung

- *light weight*
- *sturdy*
- *integral moulded handles*
- *good insulation*

Im Gegensatz zu den Thermoboxen aus Polypropylen überzeugen die Boxen aus EPP (expandiertes Polypropylen, kein Styropor) durch ihr leichtes Gewicht. Dennoch sind die Boxen robust und bruchstabil. Sie entsprechen dem HACCP-Standard und bieten beste Isoliereigenschaften. Die Reinigung kann in der Spülmaschine erfolgen, so dass sie hygienisch sauber bleiben.

In contrast to thermo boxes made of polypropylene, boxes made of EPP (expanded polypropylene, no polystyrene) convince with their light weight. Nevertheless, the boxes are robust. They comply with the HACCP standard and offer excellent insulation properties. They can be cleaned in the dishwasher so that they remain hygienically clean.

Thermobox GN 1/1

aus schwarzem EPP, für Gastronorm-Behälter GN 1/1, Außenmaß 60 x 40 cm, Innenmaß 53,5 x 33 cm

GN 1/1 Insulated Box

black EPP, for GN 1/1 containers, outside 60 x 40 cm, inside 53.5 x 33 cm



Art-Nr. Part No.	Höhe außen Outer Height cm	Höhe innen Inner Height cm	
Für 2 x 65 mm oder 1 x 100 mm übereinander: / For 2 x 65 mm or 1 x 100 mm pans:			
6830/200	20	13	22 l
Für GN 1 x 150 mm: / For 1 x 150 mm pan:			
6830/240	24	17	29 l
Für 3 x 65 mm oder 2 x 100 mm übereinander: / For 3 x 65 mm or 2 x 100 mm pans:			
6830/295	29,5	22,5	38 l
Für 4 x 65 mm übereinander: / For 4 x 65 mm pans:			
6830/330	33	26	45 l

Wir empfehlen beim Transport den Einsatz von Deckeln mit Gummidichtung Serie 8411.
We recommend the use of lids with rubber seals (8411 range) for transporting GN pans.

Universal-Thermobox, groß

aus schwarzem EPP, robuste Ausführung, Außenmaß 69 x 49 cm, Innenmaß 62,5 x 42,5 cm

Insulated Multipurpose Box

black EPP, sturdy quality, outside 69 x 49 cm, inside 62.5 x 42.5 cm



Art-Nr. Part No.	Höhe außen Outer Height cm	Höhe innen Inner Height cm	
6838/260	26	20	67 l
6838/360	36	30	78 l



Art-Nr. Part No.	Höhe außen Outer Height cm	Höhe innen Inner Height cm	
6837/180	18,5	12	14,5 l
6837/240	24,5	18	22 l
6837/330	33,5	27	33 l



Thermo- Pizzabox

aus schwarzem EPP, ideal für Pizzas und Torten, Außenmaß 41 x 41 cm, Innenmaß 35 x 35 cm

Insulated Pizza Box

black EPP, ideal for pizzas and cakes, outside 41 x 41 cm, inside 35 x 35 cm



Art-Nr. Part No.	Länge innen Inner Length cm	Breite innen Inner Width cm	Höhe innen Inner Height cm
6818/400	34,5	34,5	17



Thermobox

aus schwarzem EPP, mit Griffmulden, mit grauem Deckel, ideal für Pizzas

Insulated Box

black EPP, with built in handles, grey tight fitting lid, ideal for pizza



Art-Nr. Part No.	Höhe außen Outer Height cm	Höhe innen Inner Height cm	
Für GN 2 x 65 mm oder 1 x 100 mm Tiefe: / For 2 x 65 mm or 1 x 100 mm pans:			
6832/200	20	13	23,5 l
Für GN 1 x 150 mm: / For 1 x 150 mm pan:			
6832/240	24,5	18	33 l
Für GN 4 x 65 mm: / For 4 x 65 mm pans:			
6832/330	33	26,5	48 l

Wir empfehlen beim Transport den Einsatz von schwappsicheren Deckeln mit Gummidichtung Serie 8411.
We recommend the use of lids with rubber seals (8411 range) for transporting GN pans.



Thermobox GN 1/1

aus grauem EPS, für Gastronorm-Behälter GN 1/1, Außenmaß 60 x 40 cm, Innenmaß 54 x 34 cm

GN 1/1 Insulated Box

grey EPS, for GN 1/1 containers, outside 60 x 40 cm, inside 54 x 34 cm



Art-Nr. Part No.	Höhe außen Outer Height cm	Höhe innen Inner Height cm
6833/085	9,5	4
6833/115	12	6,5
6833/145	14,5	9,5



Thermobox für Menüschen

aus grauem EPS, Außenmaß 30 x 24 cm, Innenmaß 26 x 20 cm

Insulated Meal Box

grey EPS, outside 30 x 24 cm, inside 26 x 20 cm



Art-Nr. Part No.	Länge Length cm	Breite Width cm	Tiefe Depth cm	Gewicht Weight kg
6202/001	20,5	17	3,5	0,8



Kühlakku

zur Kühllhaltung von Speisen und Getränken, lange Kühldauer durch Spezialgel

Ice Pack

blue plastic shell, keep cold for a long time due to a special gel





Servierwagen

Innerbetriebliche Logistik im Küchenbetrieb. Das leisten die Servier- und Transportwagen von **contacto**. Sie bieten langlebige, robuste und gut verarbeitete Qualität.

Trolleys

contacto's racking, service and clearing trolleys provide the quality needed for day to day solutions.

Regalwagen GastroNorm 1/1

aus Edelstahl, gemäß DIN 18867-2, 15 Doppelauflegeschieben mit beidseitiger Kipp- und Durchschubsicherung, zum Transport von bis zu 30 GN-Tablets oder 15 GN-Behältern bis GN 1/1 (Längseinschub) bei einem Stapelabstand von 75 mm, mit 4 Lenkrollen Ø 125 mm, alle mit Feststellern

GN 1/1 Racking Trolley

stainless steel, matches EN 18867-2, takes GN trays and containers e.g. 15 pcs. GN 1/1 65 mm or 10 pcs. 100 mm deep, 4 swivel wheels Ø 125 mm, all equipped with brakes



Art-Nr. Part No.	Tiefe Depth cm	Breite Width cm	Höhe Height cm
8100/175	55	37,5	173

Lieferung unmontiert. Versand nur per Spedition.
Supplied flat packed. Pallet delivery only.

Stikkenwagen 60 x 40 cm

aus Edelstahl, gemäß DIN 18867-2, 15 Auflageschienen mit beidseitiger Kipp- und Durchschubsicherung zum Transport von bis zu 15 Tablets 60 x 40 cm (Bäckermaß) bei einem Stapelabstand von 85 mm, mit 4 Lenkrollen Ø 125 mm, alle mit Feststellern

Pastry Racking Trolley

stainless steel, matches EN 18867-2, takes up to 15 pcs. of 60 x 40 cm trays, 4 swivel wheels Ø 125 mm, all equipped with brakes



Art-Nr. Part No.	Tiefe Depth cm	Breite Width cm	Höhe Height cm
8102/015	62	47	173,5

Lieferung unmontiert. Versand nur per Spedition.
Supplied flat packed. Pallet delivery only.



Art-Nr. Part No.	Länge Length cm	Breite Width cm	Höhe Height cm
7544/007	50,6	32,5	24,5

Lieferung ohne abgebildete Deckel.
Shipped without lids shown.



GN Ablagegestell

aus Edelstahl, für sieben Deckel GN 1/1, 1/2, 1/3 sowie maximal 3,5 cm starken Schneidbrettern, Tablett u.a., zum Einschieben in GN 1/1-Regalwagen, auch als Tischgestell einsetzbar, spülmaschinengeeignet, schwere Qualität

GN Lids Rack

stainless steel wire, for seven e.g. 1/1, 1/2, 1/3 GN lids or max. 3.5 cm thick cutting boards, trays etc., fits into GN 1/1 trolleys, can be used on work surface, dishwasher safe, lids not included, heavy gauge

Art-Nr. Part No.	Länge außen Outer Length cm	Breite außen Outer Width cm	Höhe gesamt Overall Height cm
mit zwei Böden: / with 2 shelves:			
7004/002	83	51	94
mit drei Böden: / with 3 shelves:			
7004/003	83	51	94
mit fünf Böden: / with 5 shelves:			
7004/005*	83	51	154

mit zwei Böden: / with 2 shelves:

7004/002 83 51 94

mit drei Böden: / with 3 shelves:

7004/003 83 51 94

mit fünf Böden: / with 5 shelves:

7004/005* 83 51 154

*Der Versand dieser Größe ist nur per Spedition möglich.

*This size pallet delivery only.

Lieferung unmontiert.

Supplied flat packed.



Servierwagen

aus Edelstahl 18/0, Ø 25 mm Rohrdurchmesser, Montage mit feststehendem rostfreien Bolzen M12, 0,8 mm starke Ablagefläche, innen 76 x 44 cm, außen 83 x 51 cm, auf Unterseite schalldämmend beschichtet, 4 Lenkrollen Ø 125 mm, davon 2 feststellbar, Traglast 40 kg je Ebene

Service Trolley

18/0 stainless steel, Ø 25 mm tubular frame, 0.8 mm thick shelves, with 76 x 44 cm surfaces, outer dimension 83 x 51 cm, with sound absorbing base, four Ø 125 mm swivel wheels, 2 with brakes, 40 kg maximum load per shelf, assembly using stainless steel M12 bolts

Art-Nr. Part No.	Länge außen Outer Length cm	Breite außen Outer Width cm	Höhe Height cm
8109/003	71	41	85,5

Lieferung unmontiert.

Supplied flat packed.



Servierwagen, schmal

aus Edelstahl, Gestell aus Rohr Ø 25 mm, Montage mit feststehendem rostfreien Bolzen M12, 0,8 mm starke Ablagefläche, innen 63,5 x 34 cm, außen 69,4 x 39,2 cm, auf Unterseite schalldämmend beschichtet, 4 Lenkrollen mit Ø 125 mm, davon 2 feststellbar, maximale Traglast ca. 35 kg je Ebene

Service Trolley, small

stainless steel, 25 mm Ø tubular frame, 0.8 mm thick shelves, with 63,5 x 34 cm surfaces, outer dimension 69,4 x 39,2 cm, with sound absorbing base, four 125 mm Ø swivel wheels, 2 with brakes, 35 kg maximum load per shelf, assembly using stainless steel M12 bolts

Bestecksammler GN 1/3

aus Edelstahl 18/10, mit zwei Haken zum Einhängen an Servier-/Abräumwagen

Cutlery Box

18/10 stainless steel, GN 1/3 size, with two hooks to be fixed on trolleys



Art-Nr. Part No.	Länge Length cm	Breite Width cm	Höhe Height cm	
7006/325	32,5	17,6	15	5,7 l
Deckel hierzu: / Lid:				
7006/913	32,5	17,6	15	

Abfallbehälter

aus Edelstahl 18/10, mit zwei Haken zum Einhängen an Servier- und Abräumwagen, schwere Qualität

Waste Bin

18/10 stainless steel, with two hooks to be fixed on trolleys, heavy gauge



Art-Nr. Part No.	Breite Width cm	Länge Length cm	Höhe Height cm	
7008/075	18	23	18,5	7,5 l
7008/099	Auflagedeckel / Lid			
Deckel bitte separat bestellen. Please order lid separately.				

Abräumwagen für Geschirr

aus Edelstahl 18/10, wasserdichte 9,5 cm hohe Ablagen, mit 4 Lenkrollen Ø 125 mm, davon zwei mit Feststellern

Clearing trolley

18/10 stainless steel, 9.5 cm high watertight basins, 4 swivel wheels Ø 100 mm, two of them equipped with brakes



Art-Nr. Part No.	Länge außen Outer Length cm	Breite außen Outer Width cm	Höhe gesamt Overall Height cm
8104/002	80	55	92
Versand nur per Spedition möglich. Pallet delivery only.			

Abräumwagen

aus Edelstahl, mit drei Geschirrwannen aus Polypropylen in den Maßen 53 x 38 x 15 cm und zwei Eimern 26,5 x 20,5 x 31,5 cm, mit 4 Lenkrollen Ø 75 mm, davon zwei mit Feststellern, maximale Traglast 75 kg (je Wanne 15 kg)

Clearing Trolley

stainless steel, with three polypropylene 53 x 38 x 15 cm boxes and two 26.5 x 20.5 x 31.5 cm bins, 4 swivel wheels Ø 75 mm, two of them equipped with brakes, max. load 75 kg (15 kg each box)



Art-Nr. Part No.	Länge außen Outer Length cm	Breite außen Outer Width cm	Höhe Height cm
8108/850	85	45	90
Ersatzwanne: / Spare tote boxes			
8108/901	53	38	15
Ersatzeimer: / Spare bin:			
8108/902	27	20	31,5

Lieferung unmontiert in zwei Paketen.
Supplied flat packed in 2 boxes.



Art-Nr. Part No.	passend zu Matches	∅ Rad ∅ Wheel mm
3095/025	3008/025 & /030	75
3095/050	3008/050	75
3095/075	3008/075	75
3095/100	3008/100	100
3095/150	3008/150	100



Rolluntersatz, vierarmig

für Universalbehälter 3007 und 3008, Gestell aus Edelstahl 18/10, mit 4 verzinkten Gummi-Lenkrollen, davon eine mit Feststeller

4 Wheel Castors

for 3007/3008 containers, 18/10 stainless steel frame, with 4 rubber zinc plated swivel wheels, one wheel with brake



Art-Nr. Part No.	passend zu Matches	∅ Rad ∅ Wheel mm
3099/025	3008/025 & /030	100
3099/050	3008/050	100
3099/075	3008/075	100
3099/100	3008/100	100
3099/150	3008/150	100



Rolluntersatz, fünfarmig

für Universalbehälter 3007 und 3008, Gestell aus Edelstahl 18/10, mit 5 verzinkten Gummi-Lenkrollen 100 mm, davon eine mit Feststeller, besonders kippssicheres Handling durch 5-armige Konstruktion

5 Wheel Castors

for 3007/3008 containers, 18/10 stainless steel frame, with 5 rubber swivel 100 mm zinc plated wheels, one wheel with brake, for particularly safe handling by 5 wheel design



Art-Nr. Part No.	∅ min. cm	∅ max. cm
3075/845	36	47



Rolluntersatz

Gestell aus Edelstahl, mit 3 verzinkten Gummi-Lenkrollen 50 mm, geeignet für Serie 3075

Castor

stainless steel frame, with 3 rubber swivel 50 mm zinc plated wheels, fits to 3075 container



Art-Nr. Part No.	Länge Length cm	Breite Width cm	Höhe Height cm
2559/600	62	42	15



Rollwagen für Behälter

aus ABS-Kunststoff, mit 4 Lenkrollen aus Polyamid, Traglast 250 kg, für Behälter 60 x 40 cm

Trolley

ABS plastic, 4 polyamide wheels, carries up to 250 kg, for standard 60 x 40 cm boxes



Geschirrorganisation & Reinigen

Sammeln Sie ihr Geschirr ein, transportieren, reinigen und lagern Sie es.
All dies in Behältern, mit Wagen und Reinigungsmaterialien von **contacto**.

Crockery Organization & Cleaning

Organise and transport your crockery and cutlery using **contacto**'s boxes and holders.
Use our pre-rinse spray units and glass washers to clean up.

Geschirrspülkorb UNIVERSAL

grobmaschig, aus hellgrauem Polypropylen, DIN 66075-F, stapelbar, hitzeresistent bis +120°C

Dishwasher Rack

coarse mesh, light grey polypropylene, stackable, heat resistant up to +120°C, suitable for large dishes and pots & pans



Art-Nr. Part No.	Länge außen Outer Length cm	Breite außen Outer Width cm	Höhe außen Outer Height cm
2513/050	50	50	10
Erweiterungselement: / Extender:			
2520/750	50	50	4,5

Geschirrspülkorb KLEINTEILE

engmaschig, aus hellgrauem Polypropylen, DIN 66075-F, stapelbar, hitzeresistent bis +120°C

Dishwasher Rack

fine mesh, light grey polypropylene, stackable, heat resistant up to +120°C, suitable for kitchen utensils, darioles and flatware/cutlery



Art-Nr. Part No.	Länge außen Outer Length cm	Breite außen Outer Width cm	Höhe außen Outer Height cm
2521/050	50	50	10
Erweiterungselement: / Extender:			
2520/750	50	50	4,5

Geschirrspülkorb KLEINTEILE

engmaschig, aus gelbem Polypropylen, DIN 66075-F, stapelbar, hitzeresistent bis +120°C

Dishwasher Rack

fine mesh, yellow polypropylene, stackable, heat resistant up to +120°C, suitable for kitchen utensils, darioles and flatware/cutlery



Art-Nr. Part No.	Länge außen Outer Length cm	Breite außen Outer Width cm	Höhe außen Outer Height cm
2522/050	50	50	10

Geschirrspülkorb KLEINTEILE

engmaschig, aus grauem Polypropylen, DIN 66075-F, halbe Größe für geringe Hebelast, stapelbar, hitzeresistent bis +120°C

Dishwasher Rack

fine mesh, grey polypropylene, 1/2 size for easier lifting, stackable, heat resistant up to +120°C, suitable for kitchen utensils, darioles etc.



Art-Nr. Part No.	Länge Length cm	Breite Width cm	Höhe Height cm
2522/025	50	25	10

Geschirrspülkörbe

Dishwasher Racks



Art-Nr. Part No.	Länge außen Outer Length cm	Breite außen Outer Width cm	Höhe außen Outer Height cm
2517/050	50	50	10
Erweiterungselement: / Extender:			
2520/750	50	50	4,5



Geschirrspülkorb TELLER

grobmaschig, für Teller und kleine Tablett bis 46 cm, aus hellgrauem Polypropylen, DIN 66075-F, stapelbar, hitzeresistent bis +120°C

Dishwasher Rack

coarse mesh, light grey polypropylene, stackable, heat resistant up to +120°C, suitable for plates and small trays up to 46 cm



Art-Nr. Part No.	Länge außen Outer Length cm	Breite außen Outer Width cm	Höhe außen Outer Height cm
2518/050	50	50	10



Geschirrspülkorb TELLER

grobmaschig, aus grünem Polypropylen, DIN 66075-F, stapelbar, hitzeresistent bis +120°C

Dishwasher Rack

coarse mesh, green polypropylene, stackable, suitable for plates and trays



Art-Nr. Part No.	Glashöhe height of glass cm	Ø Glas max. Ø Glass max. cm	Anzahl Fächer Slots
2518/009	8	15,5	9=3x3
2518/016	8	11,5	16=4x4
2518/020*	8		20=5x4
2518/025	8	9	25=5x5
2518/036	8	7	36=6x6
2518/049	8	6	49=7x7

*Maximales Tassenmaß: 9 x 11 cm.

*Maximum cup size: 9 x 11 cm.

Erweiterungselemente: / Extender:			
2518/709	4	15,5	9
2518/716	4	11,5	16
2518/725	4	9	25
2518/736	4	7	36
2518/749	4	6	49

Maximale Glashöhe bei einem Erweiterungselement: 124 mm, bei zwei: 164 mm, drei: 204 mm, vier: 244 mm.

Maximum glass height with one extender: 124 mm, with two: 164 mm, with three: 204 mm, with four: 244 mm.



Geschirrspülkorb GLAS/TASSE

mit Facheinteilung aus hellgrauem Polypropylen, DIN 66075-F (50 x 50 cm), stapelbar, hitzeresistent bis +120°C, durch blaue Aufsätze lässt sich die Nutzhöhe um jeweils 4 cm erweitern

Dishwasher Rack

light grey polypropylene, stackable, size: 50 cm x 50 cm, heat resistant up to +120°C, suitable for glasses, by using blue extender the height can be increased by 4 cm



Art-Nr. Part No.	Länge außen Outer Length cm	Breite außen Outer Width cm	Höhe außen Outer Height cm
2529/050	50	50	10



Geschirrspülkörbe für Tablett

aus hellgrauem Polypropylen, DIN 66075-F, stapelbar, hitzeresistent bis +120°C, eine Seite offen für größere Tablett

Dishwasher Rack

light grey polypropylene, stackable, heat resistant up to +120°C, one side open for larger trays



Art-Nr. Part No.	Größe Size cm
2538/050	50 x 50



Deckel zu Spülkörben

aus blauem Polypropylen, DIN 66075-F, hitzeresistent bis +120°C

Lid for Dishwasher Racks

blue polypropylene, stackable, heat resistant up to +120°C



Gitterabdeckung

aus hellgrauem kunststoffummantelten Stahl,
sehr stabile Qualität,
passend zu 50 x 50 cm Geschirrspülkörben

Grid

plastic coated steel, fits 50 x 50 cm dishwasher racks

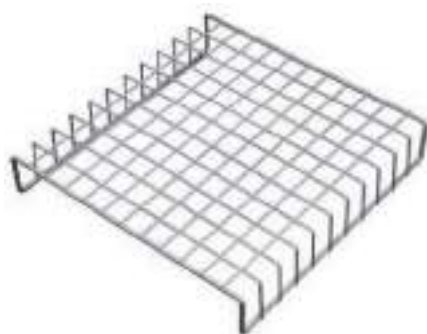

Art-Nr. Part No.	Länge Length cm	Breite Width cm	Höhe Height cm	Farbe Colour
2519/460	46	45,5	8,5	grau/grey

Transportwagen für Spülkörbe

aus Edelstahl 18/10, fest verschweißte Ausführung,
daher sehr stabil und langlebig, mit vier Lenkrollen ohne
Feststeller, passend für Norm-Spülkörbe 50 x 50 cm

Dishwasher Rack Trolley

18/10 stainless steel, completely welded, with 4 wheels,
takes standard 50 x 50 cm dishwasher racks



Art-Nr. Part No.	Länge außen Outer Length cm	Breite außen Outer Width cm	Höhe gesamt Overall Height cm
8107/600	60	60	88

Spülkörbe bitte separat bestellen von Seite 491. Versand nur per
Spedition möglich.

Please order baskets separately on page 491. Pallet delivery only.

Besteckspülkorb

aus Polypropylen, stapelbar, mit robusten Griffen,
hitzeresistent bis +120°C

Cutlery Basket

polypropylene, stackable, heat resistant up to +120°C



Art-Nr. Part No.	Länge Length cm	Breite Width cm	Höhe Height cm	Farbe Colour
2512/042	43	21	15	grau/grey

Besteckspülkorb

aus Polypropylen, stapelbar, mit robusten Griffen,
hitzeresistent bis +120°C

Cutlery Basket

polypropylene, stackable, heat resistant up to +120°C



Art-Nr. Part No.	Länge Length cm	Breite Width cm	Höhe Height cm	Farbe Colour
2512/044	43	21	15	grün/green
2512/043	43	21	15	gelb/yellow
2512/048	43	21	15	blau/blue

Besteckspülkorb

aus Edelstahl 18/10, hochglänzend, mit Tragebügeln,
spülmaschinenfest, mit 6 mm Lochung, schwere Qualität

Cutlery Basket

18/10 stainless steel, mirror polished finish,
dishwasher proof, with 6 mm perforations, heavy gauge



Art-Nr. Part No.	Länge Length cm	Breite Width cm	Höhe Height cm
1060/008	32,5	15	12,5

Mit 8 Fächern: / 8 compartments:

1060/008 32,5 15 12,5

Mit 12 Fächern: / 12 compartments:

1060/012 32,5 22,5 12,5

Besteckköcher und -behälter

Cutlery Cylinders and Baskets



contacto

Art-Nr. Part No.	Ø Einbau Ø Cut Out	Ø außen Ø Outside	Höhe Height cm
---------------------	-----------------------	----------------------	----------------------

Für Kaffeelöffel & Kuchengabeln: / For tea spoon and cake forks:
286/080 10,2 cm 12 cm 8

Für Menüöffel, -Gabel & -Messer: / For table cutlery
286/117 10,5 cm 11,5 cm 13



Besteckköcher

ungelocht, aus Edelstahl 18/10, hochglänzend, schwere Qualität, für Besteckbehälter 283, 284 und 258 geeignet

Cutlery Cylinder

plain, 18/10 stainless steel, mirror polished finish, suitable for cutlery holders 283, 284 and 258, heavy gauge



Art-Nr. Part No.	Ø Einbau Ø Cut Out cm	Ø außen Ø Outside cm	Höhe Height cm
2320/100	7	8,5	10
2320/150	7	8,5	15



Besteckköcher

passend zu Besteckträger 257, aus Edelstahl 18/10, schwere Qualität

Cutlery Cylinder

matches holder 257, 18/10 stainless steel, heavy gauge



Art-Nr. Part No.	Ø Einbau Ø Cut Out cm	Ø außen Ø Outside cm	Höhe Height cm
285/117	10,3 cm	11,5 cm	13,5



Besteckköcher

seitlich und unten perforiert, aus Edelstahl 18/10, hochglänzend poliert, mit eingepprägten Füßen, für Besteckbehälter 283, 284 und 258 geeignet

Cutlery Cylinder

wall and bottom perforated, 18/10 stainless steel, mirror polished finish, with pressed feet, suitable for cutlery holders 283, 284 and 258



Art-Nr. Part No.	Ø Einbau Ø Cut Out cm	Ø außen Ø Outside cm	Höhe Height cm
282/113	9,5 cm	12 cm	13,5



Besteckköcher

seitlich und unten perforiert, aus weißem Polyethylen, mit Füßen, ideal für versilberte Bestecke und empfindliche Klingen aus Edelstahl 18/0, für Besteckbehälter 283, 284 und 258 geeignet

Cutlery Cylinder

wall and bottom perforated, white polyethylene, with feet, particularly good for silverplated cutlery, suitable for cutlery holders 283, 284 and 258



Art-Nr. Part No.	Größe Size cm	Höhe Height cm
2514/110	11 x 11	14



Besteckköcher, eckig

perforiert, aus weißem Polyethylen, ideal für versilberte Bestecke und empfindliche Klingen aus Edelstahl 18/0

Cutlery Holder

perforated, white polyethylene, particularly good for silverplated cutlery



Art-Nr. Part No.	Ø dia. cm	Höhe Height cm	Farbe Colour
4784/150	12	15	natur/natural
4784/153	12	15	braun/brown
4784/157	12	15	schwarz/black



Besteckkorb, hoch

Geflecht ganz aus Polypropylen, spülmaschinengeeignet, schwere Qualität

Cutlery Basket

polypropylene, dishwasher safe, heavy gauge



Besteckköchergestell

aus Edelstahl 18/0, Tower zur Aufnahme von 4 Besteckköchern mit Durchmesser 10 cm, mit rutschfesten Füßen

Cutlery Holder

18/0 stainless steel, takes 4 cutlery holders with 10 cm diameter, with non-slip feet



Art-Nr. Part No.	Länge Length cm	Breite Width cm	Höhe Height cm
258/004	32	15	53

Lieferung ohne Besteckköcher.
Please order cutlery cylinders separately.

Besteckbehälter

aus Edelstahl 18/0, seidenmatt poliert, für Besteckköcher, einreihig mit 10 cm Lochdurchmesser, mit rutschfesten Füßen, schwere Qualität

Cutlery Holder

single, 18/0 stainless steel, satin polished finish, for cutlery cylinders, with non-slip feet



Art-Nr. Part No.	Länge Length cm	Breite Width cm	Höhe Height cm
283/003	42,5	15	15

Für 3 Besteckköcher: / For 3 cutlery cylinders:

283/003 42,5 15 15

Für 4 Besteckköcher: / For 4 cutlery cylinders:

283/004 56,5 15 15

Lieferung ohne Besteckköcher.
Please order cutlery cylinders separately.

Besteckbehälter

aus Edelstahl 18/0, seidenmatt poliert, für vier, sechs bzw. acht Besteckköcher, zweireihig mit 10 cm Lochdurchmesser, mit rutschfesten Füßen, schwere Qualität

Cutlery Holder

double row, 18/0 stainless steel, satin polished finish, for 4, 6 or 8 cylinders, with non-slip feet



Art-Nr. Part No.	Länge Length cm	Breite Width cm	Höhe Height cm
284/004	26	30	20

Für 4 Besteckköcher: / For 4 cutlery cylinders:

284/004 26 30 20

Für 6 Besteckköcher: / For 6 cutlery cylinders:

284/006 38 30 20

Lieferung ohne Besteckköcher.
Please order cutlery cylinders separately.

Besteckkasten für Einsätze 7002

aus Edelstahl 18/10, matt poliert, mit rutschfesten Füßen

GN Cutlery/Food Preparation Holder for 7002/001

18/10 stainless steel, satin polished finish, with non-slip feet



Art-Nr. Part No.	Länge Length cm	Breite Width cm	Höhe gesamt Overall Height cm
7003/003	55,5	32	22

Für 3 Einsätze (Art. 7002/001): / Takes 3 boxes 7002/001

7003/003 55,5 32 22

Für 4 Einsätze (Art. 7002/001): / Takes 4 boxes 7002/001

7003/004 72,5 32 22

Für 5 Einsätze (Art. 7002/001): / Takes 5 boxes 7002/001

7003/005 89,5 32 22

Einsätze bitte separat bestellen.
Please order boxes separately.

Besteckeinsatz GN 1/4

aus Edelstahl 18/10, mit aufklappbarem Deckel aus Acryl, mit abgeschrägtem Boden

GN Cutlery / Food Preparation Box

18/10 stainless steel, hinged acrylic lid



Art-Nr. Part No.	Tiefe Depth	GN
7002/001	155 mm	1/4

7002/901 Ersatzdeckel / Spare Lid

GN-Systemmaß 1/4: 265 x 162 mm

GN 1/4 size: 265 x 162 mm

Art-Nr. Part No.	Länge Length cm	Breite Width cm	Höhe Height cm
56/550	53	32,5	10

Deckel hierzu aus weißem Polypropylen, stapelbar: / Matching white food safe polypropylene lid, stackable:

56/955	53,5	33	4
--------	------	----	---



Besteckmulde

aus grauem Polypropylen, GN 1/1, vier Mulden, max. Bestecklänge 24 cm, robuste Qualität

Cutlery Box

grey polypropylene, GN 1/1 size, four compartments, max. length of cutlery 24 cm, heavy gauge



Art-Nr. Part No.	Länge Length cm	Breite Width cm	Höhe Height cm
2556/600	60	40	12

Passende Besteckmulde bitte separat bestellen / Please order matching cutlery box separately:

56/550	53	32,5	10
--------	----	------	----



Transportbehälter für Besteckkasten

aus grauem HD-Polyethylen, für GN-Besteckkasten 56/550, stapelbar, mit flachem, aufklappbarem und verschließbarem Aufgatedeckel, robuste Qualität

Transport/Storage Box for Cutlery

high density polyethylene, takes cutlery box 56/550, adjustable and lockable lid, stackable, heavy gauge



Art-Nr. Part No.	Länge Length cm	Breite Width cm	Höhe Height cm
7544/007	50,6	32,5	24,5

Lieferung ohne abgebildetem Deckel.
Shipped without lid shown.



GN Ablagegestell

aus Edelstahl, für sieben Deckel GN 1/1, 1/2, 1/3 sowie maximal 3,5 cm starken Schneidbrettern, Tablett u. a., zum Einschieben in GN 1/1-Regalwagen, auch als Tischgestell einsetzbar, spülmaschinengeeignet, schwere Qualität

GN Lids Rack

stainless steel wire, for seven e.g. 1/1, 1/2, 1/3 GN lids or max. 3.5 cm thick cutting boards, trays etc., fits into GN 1/1 trolleys, can be used on work surface, dishwasher safe, lids not included, heavy gauge



Art-Nr. Part No.	Länge Length cm	Breite Width cm	Höhe Height cm	Anzahl Fächer Slots
7566/006	30	10	14	6

Lieferung ohne abgebildetem Deckel.
Shipped without lid shown.



Ablagegestell für Deckel

aus zweifach verchromtem Stahldraht, geeignet für sechs Deckel von 14 cm bis etwa 32 cm Durchmesser

Lid Rack

steel wire, double chrome plated, for 6 lids of 14 cm to 32 cm diameter



Art-Nr. Part No.	Höhe Height cm	Breite max. Max. Width cm	Ablagehöhe Rack height cm
7568/680	64	23	6

Lieferung ohne Befestigungsmaterial.
Supplied without fixing material.



Deckelhalter

hochglanzverchromter Stahldraht, für 8 Deckel, geeignet für alle Deckelgrößen, zur Wandmontage

Lid Rack

chrome plated steel wire, for 8 lids, suitable for all sizes, wall fitting



Tassenhalter

aus kunststoffummanteltem Stahldraht, hochwertige Beschichtung aus hellgrauem Polypropylen, ideal zum Transportieren und Lagern von Stapeltassen und -gläsern, sehr stabile Qualität

Cup Carrier

plastic coated steel, high grade polypropylene coating, for transport and storage of stackable cups, heavy gauge



Art-Nr. Part No.	Länge Length cm	Breite Width cm	Höhe Height cm	Anzahl Fächer Slots
---------------------	-----------------------	-----------------------	----------------------	------------------------

Für Tassen/Gläser bis Ø 8 cm: / For cups up to 8 cm Ø
2523/265 27 18 29,5 6

Für Tassen/Gläser bis Ø 8,7 cm: / For cups up to 8.7 cm Ø
2523/305 29,5 19,5 29 6



Transportkasten für Tassenhalter

aus grauem Polyethylen, stapelbar, in diesen Behälter passen zwei Tassenhalter 2523

Transport Box

high density polyethylene, stackable, for two cup carriers 2523



Art-Nr. Part No.	Länge außen Outer Length cm	Breite außen Outer Width cm	Höhe innen Inner Height cm
---------------------	-----------------------------------	-----------------------------------	----------------------------------

2511/400 40 30 31

2511/401 Deckel / Lid



Suppentassenhalter

aus kunststoffummanteltem Stahldraht, hochwertige Beschichtung aus hellgrauem Polypropylen, sehr stabile Qualität, ideal zum Transportieren und Lagern von Suppentassen

Soup Bowl Carrier

plastic coated steel, high grade polypropylene coating, for transport and storage of soup bowls, heavy gauge



Art-Nr. Part No.	Länge Length cm	Breite Width cm	Höhe Height cm	Anzahl Fächer Slots
---------------------	-----------------------	-----------------------	----------------------	------------------------

Für Tassen bis Ø 10,7 cm: / For bowls up to 10.7 cm Ø:
2524/355 35,5 25 29,5 6



Transportkasten für Tassenhalter

aus grauem Polyethylen, stapelbar, in diesen Behälter passt ein Tassenhalter 2524

Transport Box

grey polyethylene, stackable, for one cup carrier 2524



Art-Nr. Part No.	Länge außen Outer Length cm	Breite außen Outer Width cm	Höhe innen Inner Height cm
---------------------	-----------------------------------	-----------------------------------	----------------------------------

2511/400 40 30 31,5

2511/401 Deckel / Lid



Art-Nr. Part No.	Länge Length cm	Breite Width cm	Höhe Height cm	Anzahl Fächer Slots
---------------------	-----------------------	-----------------------	----------------------	------------------------

Für Tassen bis 8,8 cm Durchmesser: / For cups up to 8,8 cm diameter:

2527/008	35,5	27,5	30	8
----------	------	------	----	---



Tassenhalter

aus kunststoffummanteltem Stahldraht, hochwertige Beschichtung aus hellgrauem Polypropylen, sehr stabile Qualität, ideal zum Transportieren und Lagern von Stapeltassen und -gläsern

Cup Carrier

plastic coated steel, high grade polypropylene coating, for transport and storage of stackable cups, heavy gauge



Art-Nr. Part No.	Länge außen Outer Length cm	Breite außen Outer Width cm	Höhe innen Inner Height cm
---------------------	-----------------------------------	-----------------------------------	----------------------------------

2511/600	60	40	31
Deckel hierzu: / Lid: 2511/601			



Transportkasten für Tassenhalter

aus grauem Polyethylen, stapelbar, in diesen Behälter passen zwei Tassenhalter 2527

Transport Box

high density polyethylene, stackable, for two cup carriers 2523



Art-Nr. Part No.	∅ Teller cm ∅ Plate cm	Höhe cm Height cm
---------------------	---------------------------	----------------------

2526/028	28	20
----------	----	----



Tellerhalter, niedrig

aus kunststoffummanteltem Stahldraht, hochwertige Beschichtung aus hellgrauem Polypropylen, speziell angepasst an einen flachen Transportkasten 60 x 40 cm, stabile Qualität

Plate Carrier

plastic coated steel, high grade polypropylene coating, perfect for stowing and transporting plates, bowls and plate covers, heavy gauge



Art-Nr. Part No.	Länge außen Outer Length cm	Breite außen Outer Width cm	Höhe innen Inner Height cm
---------------------	-----------------------------------	-----------------------------------	----------------------------------

2511/621	60	40	21
2511/601 Deckel / Lid			



Transportkasten für Tellerhalter

aus grauem Polyethylen, stapelbar, in diesen Behälter passen zwei Tellerhalter 2526

Transport Box

grey polyethylene, stackable, for two plate carriers 2526



Tellerhalter

aus kunststoffummanteltem Stahldraht, hochwertige Beschichtung aus hellgrauem Polypropylen, ideal zum Transportieren und Lagern von Tellern, Schalen und Tellerdecken, sehr stabile Qualität

Plate Carrier

plastic coated steel, high grade polypropylene coating, perfect for stowing and transporting plates, bowls and plate covers, heavy gauge



Art-Nr. Part No.	∅ Teller ∅ Plate	Höhe Height
2516/013	13 cm	30 cm
2516/015	15 cm	30 cm
2516/017	17 cm	30 cm
2516/019	19 cm	30 cm
2516/020	20 cm	30 cm
2516/022	22 cm	30 cm
2516/025	25,5 cm	30 cm
2516/028	28 cm	30 cm
2516/029	29 cm	30 cm
2516/031	31 cm	30 cm
2516/032	32 cm	30 cm

Transport- und Lagerbehälter

für u.a. Tassen- und Tellerhalter, aus grauem HD-Polyethylen, stapelbar, Euronorm-Größe, flacher Aufgedeckel separat erhältlich, robuste Qualität

Transport Box

for cup, bowl and plate carriers, high density polyethylene, with lid on request, stackable, heavy gauge



Art-Nr. Part No.	Länge außen Outer Length cm	Breite außen Outer Width cm	Höhe innen Inner Height cm
Mit Griffleisten: / with moulded handles, inside: ca. 34 x 26 cm			
2511/400	40	30	31
2511/401	Deckel für /400 / Lid for /400		
Mit Grifföffnungen stirnseitig, Innenmaß: 56,5 x 36 cm (auch für GN 1/1 oder Besteckkasten 56/550 von Seite 495) / with grip holes, inside: 56.5 x 36 cm (also good for GN 1/1 or cutlery box 56/550 on page 495)			
2511/621	60	40	21,5
Mit Grifföffnungen: / With grip holes:			
2511/600	60	40	31
2511/642	60	40	42
2511/601	Deckel für 60x40cm / Lid for 60x40cm		

Rollwagen für Behälter

aus ABS-Kunststoff, mit 4 Lenkrollen aus Polyamid, Traglast 250 kg, für Behälter 60 x 40 cm

Trolley

ABS plastic, 4 polyamide wheels, carries up to 250 kg, for standard 60 x 40 cm boxes



Art-Nr. Part No.	Länge Length cm	Breite Width cm	Höhe Height cm
2559/600	62	42	15

Gläserkästen

*Maximales Tassenmaß: 9 x 11 cm.
*Maximum cup size: 9 x 11 cm.



Art-Nr. Part No.	Glashöhe height of glass cm	∅ Glas max. ∅ Glass max. cm	Anzahl Fächer Slots
---------------------	-----------------------------------	-----------------------------------	------------------------

blau, 23 cm hoch, u.a. für 0,3-0,4 l Gläser: / blue, 23 cm high, for 0.3 to 0.4 L glasses:

2534/032	20,5	8,6	32
----------	------	-----	----

rot, 19 cm hoch, u.a. für 0,2 l Gläser: / red, 19 cm high, for 0.2 L glasses:

2534/050	17	6,9	50
----------	----	-----	----



Gläserkasten

aus robustem hochdichten Polyethylen, speziell für Willi Becher, aber auch andere Gläserarten geeignet, Kastengröße 74 x 38 cm, stapelbar

Glass Carrier

high density polyethylene, especially for so called Willi glasses, but suitable for other types of glasses as well, box size 74 x 38 cm, stackable



Art-Nr. Part No.	Anzahl Fächer Slots	∅ Glas max. ∅ Glass max. cm	
---------------------	------------------------	-----------------------------------	--

2557/715	15	10,5	oben/upper
2557/815	15	10,5	unten/lower

2557/724	24	8,5	oben/upper
2557/824	24	8,5	unten/lower

2557/740	40	6,5	oben/upper
2557/840	40	6,5	unten/lower

z.B. in Transportkiste 31 cm hoch für Gläser bis 30 cm Höhe: / e.g. fits transport box 31 cm deep for glasses up to 30 cm height: 2511/600

2511/601 Deckel / Lid

Weitere Transportbehälter 2511 siehe Seite 498.

See on page 498 for further sizes of 2511 boxes.



Gläserereinsätze

aus grauem Kunststoff, zum Einsetzen in Transportkästen 60 x 40 cm, das untere Teil liegt auf dem Kistenboden, das obere Teil wird in die Griffaussparung der Kiste eingehängt, durch die Trennung von unteren und oberen Einsatz kann das System an unterschiedlich tiefe Behälter angepasst werden

Glassware Insert

grey plastic, fits a standard 60 x 40 cm box, the lower part is placed in the box, the upper part hangs from the handles, by separating the upper and lower part the system can be adapted to boxes of different depths

Art-Nr. Part No.	Länge Length cm	Breite Width cm	Höhe Height cm
---------------------	-----------------------	-----------------------	----------------------

PRODUKTION
EINGESTELLT
PRODUCTION
DISCONTINUED



Klappbox

aus grauem Polypropylen, Tragkraft 50 kg

Transport Box, folding

grey polypropylene, load capacity 50 kg



Art-Nr. Part No.	Länge Length cm	Breite Width cm	Höhe Height cm
---------------------	-----------------------	-----------------------	----------------------

PRODUKTION
EINGESTELLT
PRODUCTION
DISCONTINUED



Weinkiste

aus robustem Polypropylen, liegende Lagerung von 12 Flaschen 0,75 l (Wein) oder 8 Flaschen 1 l (Sekt), Tragfähigkeit 18 kg, auseinander klappbar, stapelbar, mit Etikettenhalter

Wine Box

polypropylene, takes twelve 0.75 L wine bottles or eight 1 L champagne bottles, max. load 18 kg, stackable, slot for label



Art-Nr. Part No.	Länge außen Outer Length cm	Breite außen Outer Width cm	Höhe außen Outer Height cm	
---------------------	-----------------------------------	-----------------------------------	----------------------------------	--

4545/550	56	42	13,5	20 l
----------	----	----	------	------

Innenmaße: 49 x 37 x 13 cm

Inner Size: 49 x 37 x 13 cm



Lagerbecken / Geschirrwanne

aus hellgrauem Polypropylen, mit zwei seitlichen Griffmulden, stapelbar, robuste Qualität

Transport /Storage Container

light grey polypropylene, with two built in moulded handles, stackable, heavy gauge



Mobiles Waschbecken

Rahmen und Waschbecken aus Edelstahl 18/10, Becken kann platzsparend um 90° weggeklappt werden, mit je einem Frisch- und Schmutzwasserbehälter aus stabilem Kunststoff je 19 Liter, mit Hahn und flexiblem Schlauch, Rollen zum leichten Transport, völlig autark: benötigt weder Pumpe noch Wasseranschluss, für Messen, Märkte und Veranstaltungen

Mobile Wash Basin

18/10 stainless steel frame and wash basin, which can be folded away, supplied with two 19 L plastic containers for fresh and waste water, with tap and flexible hose, on wheels, easy to transport, no need for a pump or direct water supply



Art-Nr. Part No.	Höhe Height cm	Breite Width cm	Tiefe Depth cm
Standardausführung (Packmaß): / Standard version:			
4007/850	85	45	36

3076/019 Ersatzkanister / Spare container:
Versand nur per Spedition möglich.
Pallet delivery only.

Geschirrwanne

aus dunkelgrauem recycelten Polypropylen, mit zwei seitlichen Griffmulden, stapelbar

Transport Container

light grey recycled polypropylene, with two built in moulded handles, stackable



Art-Nr. Part No.	Länge außen Outer Length cm	Breite außen Outer Width cm	Höhe außen Outer Height cm
4547/540	54,5	39,5	12,5

Standrohr für Spülbecken

aus Edelstahl 18/0, Gummipropfen passend zu den marktüblichen Abläufen 1 ¼" und 1 ½" in Spülbecken

Sink Standpipe

18/0 stainless steel, with plastic plugs suitable for 1 ¼" and 1 ½" outlets



Art-Nr. Part No.	∅ außen ∅ Outside cm	∅ Durchlauf ∅ Nozzle cm	Länge Length cm
4009/275	3	2,7	27,5

Brauseschlauch 1/2"

aus Edeltstahlgewebe, mit Kunststoff ummantelt, passend zu den Geschirrbrausen

Pre-Rinse Spray Hose 1/2"

plastic coated stainless steel, fit the pre-rinse spray units



Art-Nr. Part No.	Länge Length cm
8070/100	100 cm
8070/125	125 cm

Brausen dienen nur der Reinigung im Radius des Beckenbereiches. Der Versuch, durch Ziehen am Schlauch die Brause außerhalb dieses Bereiches einzusetzen, führt zu Zugschäden am Schlauch.
Do not pull the pre-rinse spray hose beyond the work area they are designed for. Extensive pulling will damage the hose.

Bodenpalette

aus grauem Kunststoff, ineinander verankerbar, für Kühlräume

Dunnage Floor Rack

grey plastic, modular, fit several together, for use in cold storage areas



Art-Nr. Part No.	Größe Size cm	Höhe Height cm
7580/030	30 x 30	4

Geschirrspülbrausen

Die Brausen verfügen über eine integrierte Schließverzögerung und sind somit druckschlagarm in den angeschlossenen Wasserleitungen. Der Strahl des Brausekopfs ist nicht wie bei vielen anderen Modellen auf dem Markt gefächert, sondern zu einem härterem Strahl gebündelt. Dies erhöht die Reinigungskraft der Brause. Die gute Oberflächenbearbeitung und die Funktionalität der Geschirrspülbrausen ist typisch "Made in Germany".

Diese technische Zeichnungen als PDF stehen zum Herunterladen bereit oder werden auf Anfrage gerne zugesandt.

Pre-Rinse Spray Units

All the pre-rinse spray units have an integrated backflow preventer valve that opens and closes very smoothly, which ensures an even water flow. The pre-rinse spray units have been perfectly designed to incorporate a very intense water jet for really effective cleaning. The superb quality of materials used and the excellent finish on these products is typical of items described as manufactured in Germany.

These technical drawings are available as PDF for downloading or can be sent for on request.



Geschirrspülbrause 8071

mit Einlochmischbatterie, verchromt, mit Metall-Haubengriffen, Anschlussstutzen 3/8", Batterieoberteile mit Rückschlagkegel

Pre-Rinse Spray Unit 8071

deck mounted monobloc twin tap, metal handles, back flow preventer, fixing with socket G 3/8"

Art-Nr. Part No.	Höhe Height	Ausladung Projection
---------------------	----------------	-------------------------



Geschirrspülbrause 8072

mit Einlochmischbatterie und Schwenkventil, verchromt, mit Metall-Haubengriffen, Anschlussstutzen 3/8", Batterieoberteile mit Rückschlagkegel, Schwenkauslauf mit Strahlregler

Pre-Rinse Spray Unit 8072

deck mounted monobloc twin tap, additional tap, metal handles, back flow preventer, fixing with socket G 3/8"

Art-Nr. Part No.	Höhe Height	Ausladung Projection
---------------------	----------------	-------------------------



Geschirrspülbrause 8073

mit Standmischbatterie mit Schwenkventil, verchromt, mit Metall-Haubengriffen, Batterieoberteile mit Rückschlagkegel, Umstellung für Brause oder Auslauf durch Keramikoberteil, Schwenkauslauf mit Strahlregler, Anschlussstutzen 1/2"

Pre-Rinse Spray Unit 8073

deck mounted twin pillar, additional tap, metal handles, back flow preventer, fixing with socket G 1/2"

Art-Nr. Part No.	Höhe Height	Ausladung Projection
---------------------	----------------	-------------------------



Geschirrspülbrause 8074

mit Wandmischbatterie mit Schwenkauslauf, verchromt, mit Metall-Haubengriffen, Batterieoberteile mit Rückschlagkegel, Umstellung für Brause oder Auslauf durch Keramikoberteil, Schwenkauslauf mit Strahlregler, Anschlussstutzen 1/2"

Pre-Rinse Spray Unit 8074

wall mounted, with integrated mixer tap, metal handles, back flow preventer, fixing with socket G 1/2"

Art-Nr. Part No.	Höhe Height	Ausladung Projection
---------------------	----------------	-------------------------



Geschirrspülbrause 8075

mit Wandmischbatterie und Schwenkventil, verchromt, mit Metall-Haubengriffen, Batterieoberteile mit Rückschlagkegel, Schwenkauslauf mit Strahlregler, Anschlussstutzen 1/2"

Pre-Rinse Spray Unit 8075

wall mounted, with additional tap, metal handles, back flow preventer fixing with socket G 1/2"

Art-Nr. Part No.	Höhe Height	Ausladung Projection
8075/095	950 mm	400 mm

Ablaufsieb

aus Edelstahl 18/10, mit 3 mm Lochung,
für professionelle Großküchen

Sink Strainer

18/10 stainless steel, with 3 mm holes



18/10
EDELSTAHL
STAINLESS STEEL

Art-Nr. Part No.	Länge Length cm	Breite Width cm
4010/120	11,5	6

Handwaschbecken

aus Edelstahl 18/10, zur Wandmontage, mit Hahn,
die Armatur wird durch Kniehebelmechanismus bedient,
mit Ablaufsieb, flexiblem Schlauch (1½"), 2 Anschluss-
schläuchen 3/8" und einer Montageschiene

Hand Wash Basin

18/10 stainless steel, wall mounted, with tap, operated
by knee mechanism, with drainage strainer, flexible
hose (1½"), 2 connection hoses 3/8" and mounting rail



18/10
EDELSTAHL
STAINLESS STEEL

Art-Nr. Part No.	Länge Length cm	Breite Width cm	Höhe Height cm
4001/100	40	33	23

Technische Daten auf Anfrage.
Technical drawing on request.

Handwaschbecken

aus Edelstahl 18/10, zur Wandmontage

Hand Wash Basin

18/10 stainless steel, wall mounted



18/10
EDELSTAHL
STAINLESS STEEL

Art-Nr. Part No.	Länge Length cm	Breite Width cm	Höhe Height cm
4002/200	40	31	19

Technische Daten auf Anfrage. Montageschiene im Lieferumfang.
Technical drawing on request.

Handwaschbecken

aus Edelstahl 18/10, mit Konsole zur Wandmontage

Hand Wash Basin

18/10 stainless steel, with assembly bracket for wall
mounting



18/10
EDELSTAHL
STAINLESS STEEL

Art-Nr. Part No.	Länge Length cm	Breite Width cm	Höhe Height cm
4003/300	40	31	14

Technische Daten auf Anfrage.
Technical drawing on request.

Aussugsbecken

aus Edelstahl 18/10, mit Bodenventil, Stützkonsole und
klappbarem Ablagerost, Ablauf 1½"

Sink

18/10 stainless steel, with valve, supporting bracket and
hinged grate



18/10
EDELSTAHL
STAINLESS STEEL

Art-Nr. Part No.	Länge Length cm	Breite Width cm	Tiefe Depth cm
4006/430	43	31,5	20

Technische Daten auf Anfrage.
Technical drawing on request.

Waschbecken

aus Edelstahl 18/10, mit Überlauf, Stützkonsole,
Stopfen mit Kette und Bodenventil, Ablauf 1½"

Wash Basin

18/10 stainless steel, with overflow, supporting bracket,
outlet plug with chain and valve



18/10
EDELSTAHL
STAINLESS STEEL

Art-Nr. Part No.	Länge Length cm	Breite Width cm	Tiefe Depth cm
5000/490	46	41	14

Technische Daten auf Anfrage.
Technical drawing on request.

Art-Nr. Part No.	Höhe Height cm	∅ dia. cm	
8090/050	27	9	0,5 l
8090/100	33,5	10	1 l



Sprühgerät

aus resistentem Polypropylen und Polyethylen, zum direkten Sprühen ohne Pumpdruck beim Drücken als auch Loslassen, graduierter, mit verstellbarer Düse, schwere Profiqualität

Spray

tough and chemically resistant polypropylene and polyethylene, adjustable nozzle, graduated, double action enables spraying when pressing and releasing the lever



Art-Nr. Part No.	Höhe Height cm	∅ dia. cm	
8093/006	54	20	6 l



Drucksprühgerät

aus Polyethylen und Polypropylen, graduierter, für höchste professionelle Ansprüche, mit Tragegurt, mit Handpumpe zum Aufbauen von maximal 0,35 MPa (3,5 bar) Arbeitsdruck, Griff kann leicht arretiert als Tragegriff verwendet werden, mit Manometer und verstellbarer Düse sowie Sicherheitsventil, 35 cm langer Sprüharm, 150 cm langer Schlauch, Viton®-Dichtung ermöglicht den Einsatz aggressiver Chemikalien, schwere Profiqualität

Compression Spray

for extreme demands, polyethylene and polypropylene, with carrying handle, pressure can be built up to 0.35 MPa (3.5 bar), pressure gauge, adjustable nozzle, safety valve, graduated, Viton® gaskets ensures suitability for powerful chemicals



Art-Nr. Part No.	Höhe Height cm	∅ dia. cm	
8091/150	34	12,5	1,5 l



Drucksprühgerät, lebensmittelgeeignet

aus weißem lebensmittelgeeigneten Polyethylen, für dünnflüssige Lösungen (kein Öl), mit Handpumpe zum Aufbauen von maximal 0,2 MPa (2 bar) Arbeitsdruck, mit verstellbarer Düse, Sicherheitsventil und Standfuß

Compression Spray

white polyethylene, for thin fluids (except oil), pressure can be built up to 0.2 MPa (2 bar), adjustable nozzle, safety valve



Art-Nr. Part No.	Flasche / Bottle:	
7191/100		1 l



Porzellanreiniger Etolit®

flüssiges Scheuermittel, zur Reinigung von Porzellan-geschirr, Behältern, Pfannen, Besteck und Ceran®-Kochfeldern

Porcelain Cleaner

liquid scouring agent, for crockery, containers, pans, cutlery and Ceran® stove tops

Art-Nr. Part No.	
5835/015	150 ml

Lieferbar im Karton à 6 Stück oder einzeln.
Can be supplied singly or boxed in 6's.



Reinigungscreme Kupfer

für Kupfer/Messing und vergoldeten Gegenständen, zur Reinigung z.B. von Töpfen, Kasserollen, Pfannen und Kerzenhaltern

Copper Cleaning Cream

for copper, brass or gold plated items, such as cookware

Gläserpülbürsten

schwarze und weiße Borsten aus Polypropylen, auf stabiler schwarzer Kunststoffplatte 19 x 10 cm, mit 4 Saugfüßen

Glass Washer

3 polypropylene brushes, on 19 x 10 cm strong black plastic base, with 4 feet



Art-Nr. Part No.	Ø Bürste Ø Brush cm	Höhe Height cm
5888/218	7	18 / 18 / 18
5888/318	7	18 / 24 / 18
für Weizen gläser:		
5888/324	7	24 / 24 / 24
5890/901	Ersatzsaugfuß / spare foot	

Gläserpülbürsten

schwarze und weiße Borsten aus Polypropylen, auf Aluminiumplatte 19 x 10 cm, mit 4 Saugfüßen

Glass Washer

3 polypropylene brushes, on 19 x 10 cm aluminium base, with 4 feet



Art-Nr. Part No.	Ø Bürste Ø Brush cm	Höhe Height cm
5890/218	7	18 / 18 / 18
5890/318	7	18 / 24 / 18
5890/324	7	24 / 24 / 24
für Kölschgläser: / for slim glasses:		
5890/325	5,5	24 / 24 / 24
5890/901	Ersatzsaugfuß / spare foot	

Gläserpülbürsten

schwarze und weiße Borsten aus ABS, auf großer Saugplatte, dadurch besonders hohe Standfestigkeit

Glass Washer

three ABS brushes



Art-Nr. Part No.	Ø Bürste Ø Brush cm	Höhe Height cm
5891/218	7	18 / 18 / 18
5891/318	7	18 / 24 / 18
5891/324	7	24 / 24 / 24

Gläserpülgerät

mit getrennter Vor- und Nachspülung, zwei Wasser-sperrventile, integriertes belüftetes Rückschlagventil, abnehmbarer Gehäuseboden, seitliche Nachspülarme, mit offener Nachspülung, Innenbürste durch Bajonettverschluss schnell zu lösen, für alle gängigen Gläserarten geeignet, auch für Weizenbier- und 1 l-Henkelgläser

Glass Washer

with separate pre-rinsing and rinsing, two water stop valves, integrated ventilated non-return valve, detachable case back, lateral flushing arms, with open rinsing, inner brush can be quickly loosened by bayonet lock, suitable for nearly all glasses



Art-Nr. Part No.	Länge Length cm	Breite Width cm	Höhe Height cm
5897/340	31	19	34
5897/901	Ersatzbürste Außenrand / Spare outer brush		
5897/902	Ersatz-Mittelbürste / Spare inner brush		
5897/600	100 Spültabletten / 100 washer tablets		

Gläserpülgerät

mit getrennter Vor- und Nachspülung, zwei Wasser-sperrventile, integriertes belüftetes Rückschlagventil, abnehmbarer Gehäuseboden, mit geschlossener Nachspülung, Innenbürste durch Bajonettverschluss schnell zu lösen, für alle gängigen Gläserarten geeignet, auch für Weizenbier- und 1 l-Henkelgläser

Glass Washer

with separate pre-rinsing and rinsing, two water stop valves, integrated ventilated non-return valve, detachable case back, with closed rinse, inner brush can be quickly loosened by bayonet lock, suitable for nearly all glasses



Art-Nr. Part No.	Länge Length cm	Breite Width cm	Höhe Height cm
5866/002	38	20	36
5866/903	Ersatzbürste Außenrand / Spare outer brush		
5897/902	Ersatz-Mittelbürste / Spare inner brush		
5897/600	100 Spültabletten / 100 washer tablets		

Art-Nr. Part No.	Länge Length	Breite Width
6560/600	60 cm	45 cm



Gläserntuch

aus reiner Baumwolle, Gewicht 210 GSM (g/m²), weiß, robust, fusselfarm, schnell trocknend und saugfähig, mit Aufhängeöse

Glass Cloth

pure cotton, quality 210 GSM (g/sqm), white, machine washable, robust, quick drying and very absorbent



Art-Nr. Part No.	Länge Length	Breite Width
6561/700	70 cm	50 cm



Geschirrtuch

aus reiner Baumwolle, Gewicht 210 GSM (g/m²), weiß mit blauen Linien, robust, fusselfarm, schnell trocknend und saugfähig, mit Aufhängeöse

Cloth

pure cotton, quality 210 GSM (g/sqm), white with blue lines, machine washable, robust, quick drying and very absorbent



Art-Nr. Part No.	Länge Length	Breite Width
6563/100	100 cm	50 cm



Grubentuch

aus reiner Baumwolle, Gewicht 110 GSM (g/m²), robust, schnell trocknend und saugfähig, mit Aufhängeöse

Cloth

pure cotton, quality 110 GSM (g/sqm), machine washable, robust, quick drying and very absorbent



Art-Nr. Part No.	Länge Length	Ø Bürste Ø Brush	Besatzlänge Brush Head
5887/010	16 cm	10 mm	4,5 cm
5887/015	24 cm	15 mm	7 cm

Für Bierleitungen: / For beer pipes:

5887/125	128 cm	23 mm	17 cm
5887/128*	128 cm	22 mm	17 cm

* mit Polyamidborsten

* polyamide bristles



Schlauchbürste

verzinkter Stahldraht mit Öse, Besatz aus gebleichten Naturborsten, speziell geeignet zur Reinigung von langen Schläuchen

Pipe Cleaner

plated steel wire with loop, natural bristles, ideal for cleaning long pipes

Art-Nr. Part No.	Länge gesamt Total Length	Ø dia.	Besatzlänge Brush Head
5886/060	30 cm	6 mm	10 cm
5886/080	30 cm	8 mm	10 cm
5886/085	55 cm	9 mm	4,5 cm



Ausgießerbürste

verzinkter Stahldraht, Besatz aus weißem Polyamid, mit Öse, geeignet zur Reinigung von Flaschenausgießern und Schläuchen

Pourer Brush

nickel plated wire steel, white polyamide bristles, with hanging loop, for cleaning pourers and tubes



Art-Nr. Part No.	Länge gesamt Total Length	Ø dia.	Besatzlänge Brush Head
5885/025	25 cm	1,5 - 2,5 cm	8 cm
5885/045	25 cm	2,5 - 4,5 cm	10 cm



Tüllenbürste

verzinkter Stahldraht mit Öse, Besatz aus weißem Polyamid mit Kopfbündel, geeignet zur Reinigung von Tüllen u.a.

Pastry Tube Brush

steel wire with hanging loop, white polyamide bristles



Zylinderbürste

verzinkter Stahldraht mit Öse, mit Besatz aus gebleichten Naturborsten, mit Wollkopf, gut geeignet zur Reinigung von zylindrischen Gefäßen

Oil and Vinegar Bottle Brush

zinc plated steel wire with hanging loop, with bleached natural bristles, woollen head



Art-Nr. Part No.	Länge gesamt Total Length cm	∅ dia. cm	Besatzlänge Brush Head cm
5881/020	52	2	12
5881/040	52	4	13

Sektglasbürste

weißer plastikummantelter Stahldraht mit Öse, mit Besatz aus gebleichten Naturborsten, mit Wollkopf, speziell geeignet zur Reinigung von Sektgläsern und -flöten

Champagne Glass Brush

white plastic coated steel wire with hanging loop, bleached natural bristles, woollen head



Art-Nr. Part No.	Länge gesamt Total Length cm	∅ dia. cm	Besatzlänge Brush Head cm
5882/030	28	3 - 1	7
5882/070	28	7 - 3,5	10

Karaffenbürste

biegsamer weißer plastikummantelter Stahldraht mit Holzgriff, Besatz aus gebleichten Naturborsten, mit Wollkopf, speziell geeignet zur Reinigung von schwer zugänglichen Dekantierkaraffen

Decanter Brush

flexible white plastic coated steel wire with wooden handle, bleached natural bristles, woollen head



Art-Nr. Part No.	Länge gesamt Total Length cm	∅ dia. cm	Besatzlänge Brush Head cm
5883/380	38	8	7

Isolierkannenschwamm

aus gelbem Schaumstoff, mit Stiel aus weißem Kunststoff, speziell zum Reinigen des Innenbereichs von Isolierkannen geeignet

Insulated Jug Cleaner

yellow foam, white handle, especially used for cleaning the inside of insulated jugs



Art-Nr. Part No.	Länge Length cm	∅ Bürste ∅ Brush cm
5864/350	34,5	5,5

PU
POLYURETHAN

Mehlbürste

mit Kunststoffborsten, mit weißem Kunststoffgriff, lebensmittelgeeignet, spülmaschinene geeignet

Flour Brush

plastic bristles, white plastic handle, food safe, dishwasher safe



Art-Nr. Part No.	Länge Length cm	Breite Width cm	Borstenlänge Bristle Length cm
1729/300	29 cm	3 cm	6 cm

TPE
THERMOPLAST
ELASTOMER

SPÜLMASCHINE
DISHWASHER

LEBENSMITTEL
FOOD SAFE

Stielschaber

ummanteltes 18 mm Stahlrohr mit schwarzem Kunststoffgriff, Klingenthalerung aus Zinkguss, Klinge aus geschärftem und gehärtetem Karbonstahl, nicht zur Anwendung auf Ceranfeldern empfohlen

Scraper

coated 18 mm handle bar, steel with black PVC handle, zinc alloy blade holder, blade made of sharpened tempered carbon steel, do not use on ceramic surfaces



Art-Nr. Part No.	Länge Length cm	Klingenbreite Blade Width cm
5876/460	46 cm	15 cm
5876/901	Ersatzklingen à 5 Stück / Spare set of 5 blades	

ZN
ZINKGUSS
CAST ZINC

Art-Nr. Part No.	Länge Length	Klingenbreite Blade Width
5877/001	37 cm	15,5 cm

Ausführung mit zusätzlicher Drahtbürste: / Version with additional wire brush:
5877/002

5877/901	Ersatzklinge / Spare blade	
5877/902	Ersatzbürste / Spare brush	



Grillreiniger

aus Aluminium, mit Klinge aus 1 mm starkem Stahl, Schutzblech aus Edelstahl, wahlweise mit Drahtbürste, sichere Bedienung, extra robuste Qualität, nicht zur Anwendung auf Ceranfeldern empfohlen

Griddle Scraper

aluminium, with stainless steel splash guard and 1 mm steel blade, optional wire brush, extremely robust, do not use on ceramic surfaces



Art-Nr. Part No.	Länge gesamt Total Length	Fläche Size
5874/240	23 cm	5 x 5 cm



Grillbürste

stabiler Kunststoffgriff, Borsten aus Messing, mit Stahlklinge zum Schaben

Griddle Brush and Scraper

strong plastic handle, with brass bristles and steel blade



Art-Nr. Part No.	Länge Length	Klingenbreite Blade Width	Borstenlänge Bristle Length
5873/001	29 cm	4 cm	2,5 cm



Drahtbürste

Griff aus blauem Polypropylen, Borsten aus Edelstahl, Klinge zum Schaben in Engstellen, ideal für Grillroste und Bratflächen, spülmaschinengeeignet

Wire Brush

blue polypropylene handle, stainless steel bristles, with stainless steel scraper, dishwasher safe



Art-Nr. Part No.	Länge Length	Breite Width	Borstenlänge Bristle Length
5871/300	30 cm	3,5 cm	2,5 cm

Nicht zur Reinigung von Edelstahlflächen geeignet.
Not suitable for stainless steel surfaces.



Drahtbürste

mit fünf Reihen Stahldrahtborsten, nicht rostfrei, auf massivem Holzgriff

Wire Brush

5 rows of steel wire, heavy wooden handle



Art-Nr. Part No.	Länge Length	Klingenbreite Blade Width
5899/045	13,5 cm	4,5 cm

5899/901 2 Ersatzklingen / 2 spare blades



Glasfeld-Schaber

aus Kunststoff, mit beweglichem Schuttschieber, insbesondere zur Reinigung von Glaskeramikflächen (z.B. Ceran®), aber auch für andere glatte Oberflächen geeignet

Ceramic Scraper

plastic, especially suitable for ceramic hobs

Art-Nr. Part No.	Länge Length	Gewicht Weight
6000/050	60 g	

Sicherheitshinweis: Nicht in unmittelbarer Nähe von Nahrungsmitteln nutzen.

Safety advise: Do not use in the immediate vicinity of any food.



Topfkratzer

aus Edelstahl, entfernt auch hartnäckigste Speisereste von Chromnickel-Edelstahlflächen ohne die Oberfläche anzugreifen, spülmaschinengeeignet

Scourer

stainless steel, cleans stainless steel surfaces without damaging them, dishwasher safe



Art-Nr. Part No.	Länge Length	Breite Width	Stärke Thickness
5875/150	15 cm	9 cm	2 cm



Reinigungsschwamm

grüner Schwamm aus Polyethylen, mit schwarzem Griff aus Polycarbonat

Multipurpose Sponge

green polyethylene sponge, with black polycarbonate handle



Abfallentsorgung

Sauberkeit am Tisch und in der Küche: Trennen Sie konsequent Abfall von Lebensmitteln mit den Produkten von **contacto** als Bestandteil Ihres funktionierenden Hygienemanagements.

Waste Disposal

Consistent cleanliness from kitchen to table, indoor and outdoor: use **contacto** products as part of your hygiene management system to collect and dispose of waste effectively.

Tischabfallbehälter

aus Edelstahl 18/0, seidenmatt gebürstet, mit Schwingdeckel

Table Top Waste Bin

18/0 stainless steel, satin polished finish, swing lid

18/0
EDELSTAHL
STAINLESS STEEL



Art-Nr. Part No.	∅ dia. cm	Höhe Height cm	
1028/090	12	15,5	1,1 l

Tischabfallbehälter

aus weißem Polypropylen, mit Schwingdeckel, mit Dekoraufdruck

Table Top Waste Bin

white polypropylene, with swing lid

PP
POLY-
PROPYLENE



Art-Nr. Part No.	∅ dia. cm	Höhe Height cm	
3056/180	12,5	18	1,8 l

Tischabfallbehälter

aus Edelstahl, hochglänzend, Klappe mit Feder, Deckel mit Bajonettverschluss

Table Top Waste Bin

stainless steel, mirror polished finish, with spring flap

INOX
EDELSTAHL
STAINLESS STEEL



Art-Nr. Part No.	∅ dia. cm	Höhe Height cm	Höhe Behälter Container Height cm	
1051/120	12	18	11,5	1,2 l

Tischabfallbehälter

Table Top Waste Bins



Art-Nr. Part No.	∅ oben ∅ Top cm	Höhe Height cm
391/120	1,1 l	11,5



Tischabfallbehälter

aus Edelstahl, hochglänzend, schwere Qualität

Table Top Waste Bin

stainless steel, mirror polished finish, heavy gauge



Art-Nr. Part No.	∅ dia. cm	Höhe Height cm	1,25 l
3069/130	13	15	



Tischabfallbehälter

aus weißem SAN-Kunststoff, stapelbar

Table Waste Bin

white SAN plastic



Art-Nr. Part No.	∅ dia. cm	Höhe Height cm	1,8 l
3067/140	13	14	



Tischabfallbehälter

aus weißem Polypropylen, mit Dekoraufdruck

Table Bin

white polypropylene



Art-Nr. Part No.	Länge Length cm	Breite Width cm
7550/150	15 cm	1,5 cm



Tisch-Krümelfernter

aus Edelstahl, hochglänzend, gewölbt, mit Metall-Clip für Hemdtasche

Crumber

stainless steel, mirror polished finish, curved, with metal clip



Art-Nr. Part No.	Größe Size cm	Stiellänge Handle Length cm
1044/145	14 x 6,5	9



Tischbürste

aus Edelstahl 18/10, hochglänzend, mit lackiertem Holzgriff, eine Bürstenwalze, zum Kehren von Krümeln

Crumb Sweeper

18/10 stainless steel, mirror polished finish, with lacquered wooden handle



Art-Nr. Part No.	Länge Length cm	Breite Width cm	Borstenlänge Bristle Length cm
5880/095	9,5	4,5	2,5



Tischbürste

mit Holzgriff, schwarze Borsten aus Polypropylen, zum Kehren von Krümeln

Crumb Sweeper

with wooden handle, black polypropylene bristles



Kehrschaufelset

aus Edelstahl 18/0 mit integriertem Handfeger, Schaufel mit Kunststofflippe, beide Teile mit Aufhängeloch

Dustpan and Brush

18/0 stainless steel, with plastic edge and plastic brush, both parts with hanging hole



Art-Nr. Part No.	Fläche Size cm	Länge Length cm
7528/040	23 x 22	40

Kehrschaufelset

blau lackiertes Stahlblech, mit Gummikante, Kehrbesen aus Kunststoff, beide Teile mit Aufhängeloch

Dustpan and Brush

blue lacquered steel, rubber edge, plastic brush, both parts with hanging hole



Art-Nr. Part No.	Länge gesamt Total Length cm	Breite Width cm
7535/002	36,5	25,5

Kehrschaufelset

ergonomisch gestaltet: abgewinkelter Tragegriff in 74 cm Hüfthöhe, angenehme Tragehöhe, stabile Ausführung aus grauem Polypropylen und Alurahmen, verstellbarer schmalbürstiger Besen für schwer zugängliche Stellen, Teleskopstange bis 100 cm aus Aluminium mit Aufhängehaken

Dustpan and Brush

ergonomically designed: cranked handle at 74 cm waist height, comfortable carrying, sturdy construction of grey polypropylene and aluminium frame, adjustable narrow brush for reaching difficult areas, 100 cm telescopic aluminium tubular handle with hanging hook



Art-Nr. Part No.	Größe Size cm
7527/100	25 x 30 x 10

Abfallgreifer

Rohrstiel schwarz lackiert, Greifer verzinkt mit Ummantelung aus Kunststoff, automatische Rückfederung

Refuse Tongs

black painted tube handle, zinc coated tongs with plastic shield, automatic springback



Art-Nr. Part No.	Länge Length cm
7529/105	105

Warnaufsteller Rutschgefahr

mit Warnschild 'Warnung vor Rutschgefahr', zweisprachig deutsch und englisch, gemäß ASR A 1.3/BGV A8/ DIN 4844, aus gelbem Polyethylen, doppelseitig bedruckt, leicht zusammenklapp- und transportierbar

Wet Floor Sign

yellow polyethylene, identical printing on both sides, easy to fold and carry



Art-Nr. Part No.	Höhe Height cm	Breite Width cm
7672/620	60	31

Standaschenbecher

Ashtrays



Art-Nr. Part No.	Höhe Height cm	∅ Boden ∅ Base cm	∅ Ascher ∅ Ashtray cm
1614/600	60	20	15



Standaschenbecher

aus hochglanzverchromtem Stahl, mit schwerem Fuß, Aschenbecher mit Klappmechanismus

Ashtray

chrome plated, mirror polished finish, with heavy foot



Art-Nr. Part No.	Höhe Height cm	Fläche Size cm
1621/610	61	30 x 24
Innenbehälter 25 x 20 x 28 cm		
Inner tray 25 x 20 x 28 cm		



Standaschenbecher

aus matt schwarz lackiertem Stahlblech, Klappe und Becher oben aus Edelstahl, kurzer verzinkter Innenbehälter

Ashtray

matt black painted steel, stainless steel top and tray, shallow zinc plated inner tray



Art-Nr. Part No.	Höhe Height cm	∅ dia.
1623/400	60 cm	40 cm

Lieferung mit einem Beutel Sand.
Supplied with a bag of sand.



Standaschenbecher

Korpus aus schwarzem Polypropylen, Aschenplatte und Gitterrost (mit zwei Griffen) aus verzinktem Stahl, in zwei Kegel zerlegbar

Ashtray, outdoor

black polypropylene body, zinc plated steel tray and grid with two handles, can be taken apart in the middle



Art-Nr. Part No.	Höhe Height cm	∅ Säule ∅ Pole cm	∅ Boden ∅ Base cm
1622/100	100	11,5	16

4 Bohrungen mit 14 mm Durchmesser vorhanden, Schrauben im Lieferumfang.
Four 14 mm drill holes in base, supplied with bolts.



Standaschenbecher

ganz aus Edelstahl, seidenmatt poliert, zur ortsfesten Montage am Boden, abschließbarer entnehmbarer Aschenbehälter

Ashtray, outdoor

all stainless steel, satin polished, to be fitted to the ground, lockable removable liner



Art-Nr. Part No.	Höhe Height cm	∅ dia. cm
1625/275	28	13

Zwei Bohrungen mit 10 mm Durchmesser vorhanden, Schrauben im Lieferumfang.
Two 10 mm drill holes for wall mounting, supplied with bolts.



Wandaschenbecher

aus Edelstahl, zur Wandmontage, abschließbarer entnehmbarer Aschenbehälter aus Aluminium

Ashtray, outdoor

stainless steel, wall fitting, lockable removable aluminium liner



Art-Nr. Part No.	Länge Length cm	Breite Width cm	Höhe Height cm
538/085	8,5	7,5	5



Wandaschenbecher

aus eloxiertem Leichtmetall, silberfarben, mit vier Ablagen, kann zur leichten Entleerung hoch gekippt werden, hochqualitative Ausführung

Ashtray

wall mounted, anodised silver aluminium, easy to clean



Aschenbecher

aus Edelstahl 18/0, seidenmatt gebürstet, stapelbar durch Bodenrinne, Materialstärke: 1,5 mm, extra schwere Qualität

Ashtray

18/0 stainless steel, satin polished finish, material thickness: 1.5 mm, stackable, extra heavy gauge



Art-Nr. Part No.	∅ dia.	Höhe Height
537/080	8 cm	3 cm
537/100	10 cm	3 cm
537/120	12 cm	3 cm

Aschenbecher

aus Edelstahl, hochglänzend

Ashtray

stainless steel, mirror polished finish



Art-Nr. Part No.	Größe Size cm
4688/125	12,5 x 12,5 x 2,5

Aschenbecher

aus Edelstahl 18/10, außen hochglänzend, innen matt poliert

Ashtray

18/10 stainless steel, mirror polished outside, satin polished inside



Art-Nr. Part No.	∅ dia.	Höhe Height
547/138	13,5 cm	2,2 cm

Aschenbecher

aus Edelstahl, hochglänzend

Ashtray

stainless steel, mirror polished finish



Art-Nr. Part No.	∅ dia.	Höhe Height
4699/125	12,5 cm	2 cm

Windaschenbecher

zweiteilig, aus Edelstahl 18/10, außen hochglänzend, schwere Qualität

Ashtray

two piece, 18/10 stainless steel, mirror polished outside, heavy gauge



Art-Nr. Part No.	∅ dia.	Höhe Height
215/120	11 cm	3,5 cm

Windaschenbecher

zweiteilig, aus Edelstahl 18/10, hochglänzend, extra tief zum Befüllen mit Sand oder Wasser, schwere Qualität

Ashtray

two piece, 18/10 stainless steel, outside mirror polished, extra deep to take sand or water, heavy gauge



Art-Nr. Part No.	∅ dia. cm	Höhe Height cm
536/110	11	5,5

Windaschenbecher

zweiteilig, aus Edelstahl 18/10, seidenmatt gebürstet, Klappdeckel aus Edelstahl 18/0

Ashtray

two piece, 18/10 stainless steel, satin polished finish, 18/0 stainless steel hinged top



Art-Nr. Part No.	∅ dia. cm	Höhe Height cm
535/115	11,5	5,3



Art-Nr. Part No.	∅ dia. cm	Höhe Height cm
2735/105	10,5	3,5



Glas-Aschenbecher

aus klarem Glas, 4 Zigarettenablagen

Ashtray

clear glass



Art-Nr. Part No.	∅ dia. cm	Höhe Height cm
7172/120	12	7,5



Zigarrenaschenbecher

aus Edelstahl 18/10, hochglänzend poliert, mit abnehmbarem Aufsatz, schwere Qualität

Cigar Ashtray

18/10 stainless steel, mirror polished finish, heavy gauge



Art-Nr. Part No.	Länge Length cm	Klingenlänge Blade cm
7170/100	10	2,5



Zigarrenscheider

aus Edelstahl 18/10, hochglänzend, im Kunstlederetui

Cigar Cutter

18/10 stainless steel, mirror polished finish



Art-Nr. Part No.	Länge gesamt Total Length cm	∅ dia. cm	Borstenlänge Bristle Length cm
5879/220	22	3	5



Aschenbecherpinsel

Griff aus naturbelassenem Holz, Naturborsten verkapselt, mit Aufhängeloch zum Befestigen mit einer Schnur am Ascheneimer

Ashtray Brush

natural bristles, natural wood handle with hanging loop for fixing next to ashtray/bin



Art-Nr. Part No.	Länge gesamt Total Length cm	∅ dia. cm	Borstenlänge Bristle Length cm
5878/180	18	2,5	4



Aschenbecherpinsel

aus Holz mit Naturborsten, einfache Ausführung, mit Aufhängeloch

Ashtray Brush

wooden handle and natural bristles, with hanging hole



Art-Nr. Part No.	Breite Width cm	Höhe Height cm	Tiefe Depth cm	
7525/200	20	9,5	14	2,5 l



Aschenbehälter

aus Edelstahl 18/0, matt gebürstet, mit Scharnierdeckel und Griff, spülmaschinengeeignet, zum Entleeren von Tischaschenbechern

Ash Box

18/0 stainless steel, satin polished finish, with hinged lid and handle, dishwasher proof



Papierkorb, selbstlöschend

aus Edelstahl, mit schwarzer, matter Lackierung außen, die Deckelöffnung staut den Rauch im Innenbereich, so dass der entstehende Brand erstickt wird

Self Extinguishing Litter Bin

stainless steel, matt black coated outside, specially designed to reduce fire risk



Art-Nr. Part No.	∅ dia. cm	Höhe Height cm	∅ Loch ∅ Hole cm
1630/285	25	28,5	10

Papierkorb, selbstlöschend

aus Edelstahl, hochglänzend poliert, mit verzinktem Innenbehälter, die Deckelöffnung staut den Rauch im Innenbereich, so dass der entstehende Brand erstickt wird

Waste Paper Bin

stainless steel, mirror polished finish, zinc plated liner, specially designed to reduce fire risk



Art-Nr. Part No.	∅ dia. cm	Höhe Height cm	∅ Loch ∅ Hole cm
1620/680	25	68	10
Innenbehälter ∅ 21 cm, 49 cm hoch Liner ∅ 21 cm, 49 cm high			

Papierkorb / Schirmständer

aus Edelstahl 18/0 hochglänzend, Perforierung ∅ 5 mm, Boden nicht perforiert, schwere Qualität

Waste Paper Bin / Umbrella Stand

18/0 stainless steel, mirror polished finish, 5 mm perforations (excluding base), heavy gauge



Art-Nr. Part No.	∅ dia. cm	Höhe Height cm
1611/255	25	50
1611/300	30	55

Papierkorb / Standaschenbecher

aus Edelstahl, seidenmatt, mit Netzascher-Einsatz, innerer Auffangbehälter aus verzinktem Stahl, schwere Qualität

Litter Bin / Ashtray

stainless steel, satin polished, with mesh ashtray insert, zinc plated steel bin inside, heavy gauge



Art-Nr. Part No.	∅ dia. cm	Höhe Height cm
1613/250	25	61

Papierkorb / Standaschenbecher

aus Edelstahl 18/0 hochglänzend, mit Windascher-Einsatz (nicht rostfrei), schwere Qualität

Litter Bin / Ashtray

18/0 stainless steel, mirror polished finish, with ashtray insert (not stainless), heavy gauge



Art-Nr. Part No.	∅ dia. cm	Höhe Height cm	∅ Loch ∅ Hole cm
1612/200	20	58	13



Art-Nr. Part No.	∅ dia. cm	Höhe gesamt Overall Height cm	
1619/040	30	63	24 l



PUSH-Abfallbehälter

aus Edelstahl 18/0, hochglänzend, Klappe mit Federmechanismus, Innenbehälter mit Tragebügel aus verzinktem Stahlblech

Bullet Bin

18/0 stainless steel, mirror polished, zinc plated steel inner with handle



Art-Nr. Part No.	Breite Width cm	Tiefe Depth cm	Höhe gesamt Overall Height cm	
1618/880	40	30	88	70 l



Abfallbehälter mit Schwingdeckel

aus Edelstahl 18/0, hochglänzend, Schwingdeckel aus Edelstahl 18/0, mit unempfindlicher, kratzfester Oberflächenstruktur, Bodenrand mit Gummiring, schwere Qualität

Swing Top Bin

18/0 stainless steel, swing top with anti-scratch surface, base has rubber seal, heavy gauge



Art-Nr. Part No.	∅ dia. cm	Höhe gesamt Overall Height cm	
624/025	25	73	25 l



Tretabfallbehälter

aus Edelstahl 18/0, hochglänzend, mit herausnehmbaren, verzinktem Eimer, mit Tragebügel, Deckel schließt geruchsdicht und fällt eigenständig zu, schwere Qualität

Pedal Bin

18/0 stainless steel, mirror polished finish, with black lacquered aluminium insert with handle, self closing lid, heavy gauge



Art-Nr. Part No.	∅ dia. cm	Höhe gesamt Overall Height cm	
626/080	42	73	80 l

Versand nur per Spedition möglich.
Pallet delivery only.



Tretabfallbehälter

aus Edelstahl 18/0, hochglänzend, mit herausnehmbaren, verzinktem Eimer mit Tragebügel, seitliche Trageösen, Deckel fällt eigenständig zu, schwere Qualität

Pedal Bin

18/0 stainless steel, mirror polished finish, with black lacquered steel insert with handle, self closing lid, heavy gauge



Art-Nr. Part No.	∅ dia. cm	Höhe Height cm	
629/003	17	25	3 l
629/005	20	32	5 l
629/012	25	39,5	12 l
629/020	23	60	20 l



Tretabfalleimer

Edelstahl 18/0, hochglänzend, mit schwarzem Kunststoffeinsatz, Deckel fällt eigenständig zu

Pedal Bin

18/0 stainless steel, mirror polished finish, with black plastic insert, self closing lid



Tretabfallbehälter

aus Edelstahl 18/10, hochglänzend poliert, Deckel fällt eigenständig zu, auf 4 Gummifüßen, bewegbar durch 2 Rollen, schwere Qualität, ausstattbar mit handelsüblichen Mülltüten

Pedal Bin

18/10 stainless steel, mirror polished finish, self closing lid, on 4 rubber feet, movable by 2 castors, heavy gauge, plastic rubbish bags not included



Art-Nr. Part No.	∅ dia. cm	Höhe außen Outer Height cm	
625/050	40	56	50 l
625/075	40	70	70 l
625/100	40	90	100 l

Versand nur per Spedition möglich.
Pallet delivery only.

Tretabfalleimer

aus hochdichtem Polyethylen, mit farbigem Deckel, seitliches Tretpedal

Pedal Bin

high density polyethylene, grey, with coloured lid



Art-Nr. Part No.	Breite Width cm	Höhe Height cm		Farbe Colour
3053/102	52,5	80	100 l	gelb/yellow
3053/106	52,5	80	100 l	grün/green

Versand nur per Spedition möglich.
Pallet delivery only.

Abfallbehälter

mit Deckel, aus Edelstahl 18/0, hochglänzend, herausnehmbarer verzinkter Behälter mit Tragebügel, mittelschwere Qualität

Waste Bin with Lid

18/0 stainless steel, mirror polished finish, with galvanised steel insert with handle



Art-Nr. Part No.	∅ dia. cm	Höhe gesamt Overall Height cm	
622/070	40	60	70 l

Rolluntersatz bitte separat bestellen:
Please order castors separately:
621/001

Abfallbehälter auf Rollen

aus Edelstahl 18/10, hochglänzend poliert, fünf festgeschweißte, gummibereitete Räder (∅ 75 mm)

Bin on Castors

18/10 stainless steel, mirror polished finish, five wheels with rubber tyres (∅ 75 mm)



Art-Nr. Part No.	∅ dia. cm	Höhe gesamt Overall Height cm	Höhe Behälter Container Height cm	
627/050	40	49,5	40	50 l

Deckel mit Fallgriff bitte separat bestellen: / Please order lid separately:
628/050 40



Art-Nr. Part No.	∅ innen ∅ Inside cm	Höhe Height cm
3075/035	35 l	34,5
3075/050	50 l	40
3075/075	75 l	44,5

Folgende Größen können nur per Spedition versandt werden:
For these size pallet delivery only:

3075/100	100 l	47	67
3075/200*	200 l	67	80

Deckel bitte separat bestellen: / Please order lid separately:

3075/903	34,5
3075/905	40
3075/907	44,5
3075/910	47
3075/920*	67

*Die Größe hat keine Griffe und der Deckel keine Griffmulde.
*No handles on this size and no grip hole on the lid.

Rolluntersatz hierzu siehe Seite 489.
For matching castors see page 489.



Kunststofftonne

aus weißem hochdichten Polyethylen, temperaturbeständig von -30°C bis +60°C, lebensmittelgeeignet, mit zwei Griffen, in- und aufeinander stapelbar

Bin

white high density polyethylene, withstands temperatures from -30°C to +60°C, food safe, stackable



Art-Nr. Part No.	∅ dia. cm	Höhe Height cm
3048/010	11 l	25



Kunststoffeimer

aus weißem Polypropylen, lebensmittelgeeignet, leichte Qualität

Plastic Bucket

white polypropylene, food safe



Art-Nr. Part No.	∅ dia. cm	Höhe Height cm
3071/007	7 l	24
3071/009	9 l	27



Kunststoffeimer

aus weißem Polyethylen, lebensmittelgeeignet, mit Bügel aus verzinktem Stahldraht

Plastic Bucket

white polyethylene, food safe, with zinc plated steel handle



Art-Nr. Part No.	∅ dia. cm	Höhe Height cm
3073/012	12 l	28
3073/015	15 l	30



Kunststoffeimer

aus weißem niederdichtem Polyethylen, lebensmittelgeeignet, mit Ausguss, mit Tragebügel aus verzinktem Stahldraht, geprägte Graduierung in Literschritten, stabile Qualität

Bucket

low density white polyethylene, food safe, with spout and zinc plated steel handle, graduated in litres, heavy gauge





contacto

Arbeitsschutz

Gehen Sie auf Nummer Sicher. Schützen Sie sich vor Kälte, Hitze, Schmutz und Schnittverletzungen im hektischen Küchenalltag.

Protective Work Wear

Play it safe. Protect yourself from burns and cuts with **contacto's** range of gloves and mitts.



Schnittschutzhandschuh

aus ultraleichtem extrem strapazierfähigem Polyethylen-garn hergestellt, waschbar bis max. +90°C, schnitthemmend aber nicht schnittfest, mittelschwere Qualität, gemäß DIN EN 388, höchster Schnittschuttfaktor 5, für Schneidearbeiten, Reinigungsarbeiten und Messerwechsel zum Schutz der messerführenden Hand, beidhändig tragbar

Cut Resistant Glove

from seamlessly engineered ultra-high molecular weight polyethylene yarn, superior cut and slash resistance while retaining comfort and tactile sensitivity, right/left handed, medium duty, meets EN 388, washable up to +90°C maximum



Art-Nr. Part No.	Länge Length cm	Größe Size
6526/007	23,5	S
6526/008	26	M
6526/009	28	L
6526/010	29	XL
Preis je Einzelstück. Priced each.		

Schnittschutzhandschuh

aus ultraleichtem extrem strapazierfähigem Polyethylen-garn hergestellt, waschbar bis max. +90°C, schwere Qualität, gemäß DIN EN 388, höchster Schnittschuttfaktor 5, schnitthemmend aber nicht schnittfest, für Schneidearbeiten, Reinigungsarbeiten und Messerwechsel zum Schutz der messerführenden Hand, beidhändig tragbar

Cut Resistant Glove

from seamlessly engineered ultra-high molecular weight polyethylene yarn, superior cut and slash resistance while retaining comfort and tactile sensitivity, right/left handed, heavy duty, meets EN 388, washable up to +90°C maximum



Art-Nr. Part No.	Länge Length cm	Größe Size
6527/007	23,5	S
6527/008	26	M
6527/009	28	L
6527/010	29	XL
Preis je Einzelstück. Priced each.		

Art-Nr. Part No.	Länge Length cm	Größe Size
Small (Größe 6-7):		
6540/001	22	S
Medium (Größe 8):		
6540/002	23	M
Large (Größe 8,5 - 9):		
6540/003	24	L
Extra Large (Größe 10-11):		
6540/004	25	XL
Preis je Einzelstück. Weitere Größen auf Anfrage. Priced each. Further sizes on request.		



Stechschutzhandschuh

komplett aus 0,55 mm Edelstahl draht 1.4306, Ringdurchmesser 4,2 mm, beidseitig zu tragen, variabler Hakenverschluss, hochwertige Verarbeitung, entspricht europäischer Norm EN 1082-1, geprüfte Qualität

Chain Mail Glove

18/10 stainless steel 0.55 mm mesh, ring diameter 4.2 mm, right/left handed, variable fastener, heavy gauge, fulfils European CE standard EN 1082-1



Art-Nr. Part No.	Länge Length cm	Breite Width cm
6541/300	31	10
Preis je Paar. Priced in pairs.		



Unterziehhandschuhe

Fingerlinge ganz aus Baumwolle, gestrickt, Einheitsgröße, geeignet als Unterziehhandschuh für Ketten-schutzhandschuhe, waschbar bei +60°C

Inner Gloves

knitted cotton fingers, washable



Art-Nr. Part No.	Farbe Colour
6539/099	blau/blue
Preis je Einzelstück. Priced each.	



Handschuhstraffer

blaues Fixiergummi für den optimalen Sitz von Stechschutzhandschuhen

Glove Accessory

blue rubber mould to tighten chain mail gloves



Art-Nr. Part No.	Länge Length cm	Breite Width cm
für Personen mit Körpergröße von 174-186 cm / for 174 to 186 cm height		
6556/055	85	60
Weitere Größen auf Anfrage. Further sizes on request.		



Stechschuttschürze

komplett aus Edelstahl draht 1.4306, mit hygienischer und ergonomischer TPU-Kunststoff-Kreuzberiemung, gemäß EN ISO 13998:2003 Schutzklasse 2

Chain Mail Apron

18/10 stainless steel, meets EN 13998:2003, Protection Class 2



Art-Nr. Part No.	Länge Length cm
6550/120	120



Spüllattschürze

aus TPU, resistent gegen tierische Öle und Fette, besonders hygienisch durch extrem glatte Oberfläche, leichte Reinigung, bleibt auch bei Kälte flexibel, wasserdicht

Kitchen Apron

TPU plastic, resistant to animal oils and fats, particularly hygienic due to extremely smooth surface, easy to clean, remains flexible even in cold weather, waterproof



Lederhandschuhe

Fäustlinge aus feinem Spaltleder, Innenfutter ganz aus Baumwolle, keine Schutzwirkung gegen Hitze über +50°C

Oven Mitts

fine leather, with cotton lining, no insulation against temperatures above +50°C



Art-Nr. Part No.	Länge Length cm	Breite Width cm
6532/460	46	20

Preis je Paar.
Priced per pair.

Kältehandschuhe

Fäustlinge aus blauem Polyurethan, Innenfutter ganz aus Baumwolle, für kurzzeitigen Gebrauch

Freezer Mitts

blue polyurethane, cotton lined, for short use



Art-Nr. Part No.	Länge Length cm	Breite Width cm
6531/400	36	15

Preis je Paar.
Priced per pair.

Küchenhandschuhe

Fäustlinge ganz aus gesteppter, schwarzer Baumwolle

Oven Mitts

black quilted cotton



Art-Nr. Part No.	Länge Length cm	Breite Width cm
6533/360	34	17

Preis je Paar
Priced per pair.

Küchenhandschuhe

Fäustlinge ganz aus Baumwolle, schwerer Canvas, Innenfutter weich aufgeraut, waschbar bei +40°C

Kitchen Mitts

heavy canvas, washable up to +40°C



Art-Nr. Part No.	Länge Length cm	Breite Width cm
6536/360	36	15

Preis je Paar.
Priced per pair

Art-Nr. Part No.	Länge Length cm	Breite Width cm
6543/300	30	15
6543/400	38	17

Preis je Paar.
Priced per pair



Backhandschuhe

Fäustlinge ganz aus Baumwolle, doppelte Schlinge (Frottee), Stulpe Canvas

Bakers Mitts

thick cotton, with canvas sleeve



Art-Nr. Part No.	Länge Length cm	Breite Width cm
6544/400	44,5	15

Preis je Paar.
Priced per pair



Backhandschuhe mit Stulpen

Fäustlinge ganz aus Baumwolle, einfache Schlinge (Frottee), Innenhand und Daumen verstärkt, lange Stulpe Canvas

Bakers Mitts

cotton, with canvas sleeve



Art-Nr. Part No.	Länge Length cm	Breite Width cm
6530/300	30	24

Preis je Paar.
Priced per pair.



Topflappen

ganz aus Baumwolle, doppelte Schlinge (Frottee), Rückseite mit Gummibandschlaufe, waschbar bis +40°C

Oven Cloth

heavy cotton, with elasticated loop, washable up to +40°C



Art-Nr. Part No.	Länge Length cm	Breite Width cm
6534/340	34	15

Preis je Paar
Priced per pair.



Küchen-Fingerhandschuhe

ganz aus Baumwolle, Canvas-Stulpe, waschbar bei +40°C, sehr strapazierfähig, keine Schutzwirkung gegen Hitze

Kitchen Gloves

canvas cotton, washable up to +40°C, does not protect against heat



Metalle

Metalle und unter ihnen besonders Edelstahl 18/10 sind optimal geeignet für die professionelle Gastronomie als Arbeitsgeschirr, zur Aufbewahrung von Speisen und zur effektvollen Präsentation von Speisen. Edelstahl ist absolut hygienisch, geschmacks- und geruchsneutral.

Zur Pflege aller Metalle gehört die zeitnahe Reinigung; Speisereste, Kalk und Salz müssen entfernt werden, da Metalle empfindlich gegen Säuren und Salze sind. Dies gilt insbesondere für Bestecke! Töpfe und Pfannen sollten nicht thermisch abgeschreckt werden, da sich dadurch die Böden verziehen können.



















Für alle Metalle gilt, dass sie trocken gelagert werden müssen und ganz besonders gut recyclingfähig sind.

Metals

Metals - especially 18/10 stainless steel - are ideally suited for professional catering as utensils, for storing and for presentation of food. Stainless steel is absolutely hygienic, tasteless and odourless.

The care of all metals includes prompt cleaning. Food residues, lime and salt must be removed, as metals react to acids and salts. This applies in particular to cutlery! Pots and pans should not be subjected to thermal shock, as this can distort the base.







All metals must be stored dry and are particularly suitable for recycling.

Icon Icon	Materialname Material name	Abkürzung Abbreviation					Bemerkung Note
	Edelstahl 18/10 oder 18/8 18/10 or 18/8 Stainless Steel	X 5 Cr Ni 18 10 1.4301 AISI 304	+		-50° +400°	+	Kontakt mit unedleren Metallen (Stahlwolle/Fremdstoff) und Anhaftung von Säuren/Salzen vermeiden Avoid contact with base metals (e.g. steel wool or carbon steel) and acidic and salty food residues
	Edelstahl 18/0 18/0 Stainless Steel	X 6 Cr 17 1.4016 AISI 430		+	-50° +400°	+	nickelfrei, härtbar, gut geeignet für Klingen, Salze und Säuren rasch entfernen Nickel free, good for hardening and sharpening, suitable for knife blades, remove salts and acids quickly
	Edelstahl Stainless Steel	Cr Mn Ni Cr-Ni-Stahl AISI 202, 201	+		-50° +400°	+	sehr geringer Nickelgehalt, Salze und Säuren rasch entfernen Very low nickel content, remove salts and acids quickly
	Messerstahl Knife Blade Steel	X 45 Cr Mo V 15 1.4116 AISI 420		+	-30° +300°	+	Speisereste sofort entfernen, regelmäßig abziehen Sharpen regularly, remove food residues immediately
	Aluminium Aluminium	Al			-50° +250°		sehr gute Wärmeleitung, Einsatz in Topfböden, keine scharfen Reiniger verwenden Very good heat conductivity, used for sandwich and multi-layer cookware bases, do not clean with sodium oxide or caustic soda
	Aluguss Cast Aluminium	Al 231 G-Al Si 12 Cu 1			-50° +250°		sehr gute Wärmeleitung Very good heat conductivity
	Eisen Iron	Fe		+	-50° +400°		nicht korrosionsbeständig, nicht rostfrei Not corrosion or rust resistant
	Gusseisen Cast Iron	GG-20 DIN 1691	+	+	-20° +600°		kaum überhitzbar, nicht schlagfest, nur bedingt induktionsgeeignet Virtually impossible to overheat, not shock resistant, limited suitability for induction
	Stahl, geschmiedet Forged Steel			+	-50° +400°		hohe Festigkeit, vor dem ersten Kocheinsatz „einbraten“ Hard and tough material, "fry" with oil before initial use
	Schwarzblech Blue Steel			+	-50° +400°		verzündete Oberfläche bietet gewissen Korrosionsschutz Scaled surface offers minimal corrosion protection
	Weissblech Tin Plate			+	-40° +210°		verzinnete Oberfläche bietet kurzfristigen Korrosionsschutz Tinned surface offers short term corrosion protection
	Kupfer Copper	Cu			-50° +600°		sehr gute Wärmeleitung, dekorativ, reinigungsintensiv Very good heat conductivity, decorative, requires special cleaning
	Zinkguss Zinc Casting	Zn			-50° +400°		komplizierte Formen möglich, korrodiert ungeschützt Complex shapes possible, will corrode without protection
	Messing Brass	Cu Zn			-50° +400°		dekorativ, goldfarben, antibakteriell, reinigungsintensiv Decorative, gold coloured, antibacterial, requires special cleaning

Beschichtungen

Beschichtungen verbessern die Funktionalität, die Lebensdauer oder das optische Erscheinungsbild von Produkten, wenn dies das Grundmaterial nicht leisten kann. Häufig soll die Korrosionsbeständigkeit gegen Säuren und Salze verbessert oder eine Antihafteigenschaft zugefügt werden. Produkte werden gegebenenfalls durch die Beschichtung spülmaschinengeeignet.





Nur eine unbeschädigte Oberfläche schützt das darunter liegende Material. Insbesondere PTFE-Antihaftoberflächen müssen daher pfleglich behandelt werden. Das Material darf nicht überhitzt und nicht mit harten scharfkantigen Küchenwerkzeugen bearbeitet werden.

Icon Icon	Materialname Material name	Abk. Abb.	Bemerkung Note
	verchromt <i>Chrome plated</i>	Cr	hohe Beständigkeit, aber nicht säurefest <i>High durability, not acid-resistant</i>
	versilbert <i>Silver plated</i>	Ag	hohe Beständigkeit, reinigungsintensiv <i>Durable, requires special cleaning</i>
	vergoldet <i>Gold plated</i>	Au	hohe Beständigkeit <i>High durability, requires special cleaning</i>
	verkupfert <i>Copper plated</i>	Cu	hohe Beständigkeit, reinigungsintensiv <i>High durability, requires special cleaning</i>
	verzinkt <i>Tin plated</i>	Sn	erhöhter Korrosions- und Säureschutz <i>Enhanced corrosion and acid protection</i>
	vernickelt <i>Nickel plated</i>	Ni	hohe Beständigkeit <i>High durability</i>

Coatings

Coatings improve the functionality, durability or visual appearance of products when the base material is unable to do so. Corrosion resistance to acids and salts is often improved or a non-stick property added. Products may sometimes become dishwasher safe as a result of a coating.

Only an undamaged surface protects the underlying material. PTFE non-stick coatings in particular must therefore be treated with care. The material must not be overheated and should not be used with hard, sharp-edged kitchen tools.

Icon Icon	Materialname Material name	Abk. Abb.	Bemerkung Note
	lackiert <i>Varnished/ Lacquered</i>		als Schutz oder Dekoration verwendet <i>Used for protection or decoration</i>
	pulverbeschichtet <i>Powder coated</i>		erhöhte Haltbarkeit gegenüber Lackierung <i>Increased durability compared to varnishing</i>
	Emailliert <i>Enamel</i>		harte Oberfläche, dekorative Varianten möglich <i>Hard surface, decorative variations possible</i>
	Keramik <i>Ceramic</i>		harte Oberfläche, dekorative Varianten möglich <i>Hard surface, decorative variations possible</i>
	Polytetrafluorethylen <i>Polytetrafluorethylene</i>	PTFE	gute Antihafteigenschaft, nicht kratzfest, darf nicht überhitzt werden <i>Good non-stick properties, not scratch-resistant, must not be overheated</i>

Kunststoffe

Kunststoffe haben mittlerweile ihren festen Platz in der Großküche gefunden. Insbesondere bei der Lagerung von Lebensmitteln ist die Säure- und Salzbeständigkeit von großem Vorteil.

Kunststoffgeschirre sind leicht und robust und daher ideal im Küchenalltag. Allerdings müssen sie nach dem Spülgang mit der Hand nachgetrocknet werden, denn die gespeicherte Wärme reicht nicht aus, um das Wasser restlos verdampfen zu lassen.

In der Mikrowelle – besonders bei relativ trockenen und ölhaltigen Lebensmitteln – sollten Kunststoffe mit Bedacht eingesetzt werden.





















Kunststoffe sind recyclebar. Für den Lebensmittelkontakt zugelassene Kunststoffe werden geprüft und zertifiziert.















Plastics

Plastics have found their permanent place in the professional kitchen. The acid and salt resistance is of particular advantage when storing foodstuffs.

Plastic items are light and robust and therefore ideal for everyday use in the kitchen. However, they must be dried by hand washing and rinsing because the residual heat is not sufficient to allow the water to evaporate completely. Plastics should be used carefully in the microwave - especially for relatively dry and oily foods.

Plastics are recyclable. Plastics approved for contact with food are tested and certified.







Icon Icon	Materialname Material name	Abkürzung Abbreviation	 SAURE / SALZ ACID / SALT	 ÖLBESTÄNDIG OIL RESISTANT	 BRUCHSICHER UNBREAKABLE	 TEMP. MIN. C TEMP. MAX. C	 MICROWELLE MICROWAVE	 SPÜLMASCHINE DISHWASHER	Bemerkung Note
 PP POLY- PROPYLENE	Polypropylen <i>Polypropylene</i>	PP	+	+	+	+ -0° +100°	+	+	semitransparent <i>Translucent</i>
 PE POLY- ETHYLENE	Polyethylen <i>Polyethylene</i>	PE	+	+	+	-40° +85°		+	durchlässig für O2, CO2, Aromastoffe <i>Permeable to O2, CO2, flavourings</i>
 LDPE LOW DENSITY POLYETHYLENE	High Density Polyethylen <i>High density polyethylene</i>	HDPE	+	+	+	-50° +90°		+	durchlässig für O2, CO2, Aromastoffe <i>Permeable to O2, CO2, flavourings</i>
 LDPE LOW DENSITY POLYETHYLENE	Low Density Polyethylen <i>Low density polyethylene</i>	LDPE	+	+	+	-40° +80°		+	durchlässig für O2, CO2, Aromastoffe <i>Permeable to O2, CO2, flavourings</i>
 PA POLYAMIDE	Polyamid <i>Polyamide</i>	PA	+	+	+	-20° +100°	+	+	hohe Festigkeit <i>Robust</i>
 PC POLY- CARBONATE	Polycarbonat <i>Polycarbonate</i>	PC	+	+	+	-40° +100°		+	glasähnliches Aussehen <i>Glass-like appearance</i>
 ABS ACRYLON- NITRILE	Acrylnitril-Butadien- Styrol-Copolymere <i>Acrylonitrile-butadiene- styrene polymers</i>	ABS	+	+	+	-30° +95°	+	+	gute Oberflächenhärte <i>Tough surface</i>
 POM POLYOXY- METHYLENE	Polyoxymethylen <i>Polyoxymethylene</i>	POM	+	+	+	-40° +120°	+	+	sehr fest, formbeständig <i>Very tough, retains its shape</i>
 PS POLYSTYRENE	Polystyrol <i>Polystyrene</i>	PS	+	+		-10° +70°		+	häufige Verwendung als aufgeschäumtes Material <i>Often used in the form of foam</i>
 EPS EXPANDED POLYSTYRENE	Expandiertes Polystyrol <i>Expanded polystyrene</i>	EPS	+	+		-10° +70°			UV-empfindlich, Formteile aus PS-Schaum <i>UV-sensitive, PS moulded shapes</i>
 EPP EXPANDED POLYPROPYLENE	Expandiertes Polypropylen <i>Expanded polypropylene</i>	EPP	+	+		+ -0° +85°			Formteile aus PP-Schaum ohne Treibmittel <i>PP moulded shapes without propellant</i>
 EXO GLASS	Exoglass®		+	+	+	-20° +220°	+	+	PA mit 30% Glasfaser <i>PA with 30% fibreglass</i>
 FIBER FIBERGLAS FIBREGLASS	Glasfaserverstärkter Kunststoff <i>Fibreglass reinforced plastic</i>	GFK GRP	+	+	+	-20° +60°		+	Eigenschaften je nach Laminat unterschiedlich <i>Properties vary depending on laminate</i>
 MF MELAMINE	Melamin <i>Melamine</i>	MF	+	+	+	-40° +70°		+	harte, kratzfeste Oberfläche <i>Hard, scratch-resistant surface</i>

Icon Icon	Materialname Material name	Abkürzung Abbreviation							Bemerkung Note
	Polyvinylchlorid <i>Polyvinyl chloride</i>	PVC	+	+	+	-15° +60°			abriebfest <i>Durable</i>
	Styrol-Acrylnitril-Copolymer <i>Styrene acrylonitrile copolymer</i>	SAN	+	+		-20° +80°		+	höhere Schlagzähigkeit, Steifigkeit und Kratzfestigkeit als PS <i>Higher impact strength, stiffness and scratchresistance than PS</i>
	Poly(organo)siloxane <i>Poly(organo)siloxanes</i>	SILIKON	+	+	+	-40° +210°	+	+	sehr elastisch auch bei tiefen Temperaturen <i>Very elastic even at low temperatures</i>
	Polymethylmethacrylat <i>Polymethyl methacrylate</i>	PMMA	+	+	+	-40° +80°		+	glasähnliches Aussehen, härter als PC <i>Glass-like appearance, harder than PC</i>
	Polyurethan <i>Polyurethane</i>	PUR	+	+	+	-20° +75°		+	große Vielfalt verschiedener Materialien <i>Wide variety of different materials</i>
	Gummi <i>Natural rubber</i>	NR	+		+	-30° +90°	+	+	nicht alterungsbeständig, Ausgangsmaterial Naturkautschuk <i>Not resistant to ageing</i>
	Thermoplastische Elastomere <i>Thermoplastic elastomer</i>	TPE	+	+	+	-20° +100°	+	+	große Vielfalt verschiedener Materialien <i>Wide variety of different materials</i>
	Polymere mit Esterfunktionen <i>Polymers with ester functions</i>	PEs	+	+	+	-20° +180°			meist als Harz oder Faser verwandt <i>Mostly used as resin or fibre</i>

Naturstoffe

Organische Materialien sind meist schnell nachwachsend und lassen sich bestens entsorgen. Ihre besonderen Eigenschaften machen Sie zu wertvollen Rohstoffen für Gastronomieprodukte.



Glas und Porzellan eröffnen eine unendliche Formenvielfalt bei gleichzeitig hoher chemischer und mechanischer Resistenz.

Icon Icon	Materialname Material name	Bemerkung Note
	Holz <i>Wood</i>	nachhaltiges Naturprodukt, hohe Haltbarkeit <i>Sustainable natural product, high durability</i>
	Bambus <i>Bamboo</i>	schnellwachsender Rohstoff, vielfältige Anwendungsmöglichkeiten <i>Fast growing raw material, various applications</i>
	Kork <i>Cork</i>	aus Rinde der Korkeiche, sehr elastisch, schwer entflammbar, guter Wärmeisolator <i>Made of the bark from cork oak, very elastic, flame retardant, good thermal insulator</i>
	Leder <i>Leather</i>	durch Gerbung haltbar gemachte Tierhaut, wasserundurchlässig, atmungsaktiv <i>Tanned animal skin, waterproof, breathable</i>
	Textil <i>Textile</i>	kann sowohl aus einer Natur- oder einer chemischen Faser hergestellt werden <i>Can be made of a natural or chemical fibre</i>
	Porzellan <i>Porcelain</i>	dichtes und hartes Material, leicht transparent, hohe Schnittfestigkeit, hygienisch, lange Haltbarkeit <i>Dense and hard material, high cut resistance, hygienic, long durability</i>

Natural Materials

Organic materials are usually fast growing and can easily be disposed of. Their special properties make them valuable raw materials for different kinds of catering products.

Glass and porcelain open up an infinite variety of shapes with both high chemical and mechanical resistance.















Icon Icon	Materialname Material name	Bemerkung Note
	Leinen <i>Linen</i>	aus Flachs gewonnen, flusenfrei, antistatisch, schmutzabweisend, unempfindlich gegen chemische Reinigung und Waschlaugen, nicht verwendbar im Wäschetrockner <i>Made from flax, lint-free, antistatic, dirt-repellent, insensitive to dry cleaning and, washing, cannot be used in tumble dryers</i>
	Baumwolle <i>Cotton</i>	Naturfaser, hautfreundlich, hohe Saugfähigkeit, trocknet langsam, hohe Schmutz- und Ölaufnahmefähigkeit <i>Natural fibre, skin-friendly, high absorbency, dries slowly</i>
	Glas <i>Glass</i>	lässt praktisch keine Wechselwirkung zwischen Inhalt und Verpackung zu, unverfälschter Geschmack von Lebensmitteln und Getränken, recyclebar <i>Allows virtually no interaction between contents and packaging, unadulterated taste of food and beverages, recyclable</i>







Hinweise: Anwendung/Eigenschaften

Notes: Application/Properties

Icon Icon	Anwendung/Eigenschaft Application/Property	Bemerkung Note	Icon Icon	Anwendung/Eigenschaft Application/Property	Bemerkung Note
	Spülmaschinenfest <i>Dishwasher proof</i>	Spülmaschinenfestigkeit garantiert eine bestimmte Anzahl von Spülzyklen. <i>Dishwasher proof guarantees a certain number of dishwasher cycles.</i>		Gas <i>Gas</i>	Gaskochstellen sind neben Elektroherden die klassische Herdart in der Gastronomie. Wegen der von den Herden ausgehenden Brandgefahr werden Sie heute immer häufiger durch die Induktionstechnik ersetzt, die ähnlich schnell anheizt. <i>Besides electric cookers, gas hobs are a classic cooking method. Because of the risk of fire they are frequently being replaced by induction technology, which heats up at a similar rate.</i>
	Spülmaschinengeeignet <i>Dishwasher safe</i>	Spülmaschineneignung garantiert eine bestimmte Anzahl von Spülzyklen. <i>Dishwasher safe for a certain number of dishwasher cycles.</i>		Induktion <i>Induction</i>	Energiesparende Technik mit hoher Betriebssicherheit, kurzer Anheizdauer, geringem Platzbedarf und leichter Reinigung. Es sind Kochgeschirrböden mit Ferritkern nötig <i>Energy saving technology with high operational reliability, short heat-up time, low space requirement, safer than other cooking methods and easy to clean. Cookware with a magnetic base is needed.</i>
	Nicht spülmaschinengeeignet <i>Not dishwasher safe</i>	Dieser Artikel darf nicht in der Spülmaschine gereinigt werden. Hier ist eine Handreinigung empfohlen. <i>This item must not be washed in a dishwasher. It should be cleaned by hand only.</i>		Bedingt für Induktion <i>Restricted Induction</i>	Aufgrund der Größe oder Materialbeschaffenheit ist der Artikel nicht auf allen Induktionskochstellen zu verwenden. <i>Due to the size or material properties, this article cannot be used on all induction hobs.</i>
	Spülautomat <i>Dishwasher</i>	Diese Geschirre sind ausgelegt für den Einsatz in Spülautomaten, die Bestecke durch Magnete aufnehmen können. <i>These items are designed for use in dishwashing machines that can pick up cutlery using magnets.</i>		Backofengeeignet <i>Oven safe</i>	Backofenfeste Materialien verändern sich nicht bei Temperaturen wie sie in Backöfen typisch sind. <i>Oven safe materials do not change at typical temperatures used for ovens.</i>
	Handreinigung <i>Hand wash</i>	Verschiedene Geschirre und bestimmte Materialien verlangen eine Handreinigung, weil sie entweder dem hohen mechanischen Druck des Wasserstrahls, dem Chemikalieneinsatz, der im Spülraum herrschenden Temperaturen oder der zeitlichen Länge des Wasserkontakts nicht standhalten. <i>Various dishes and other items require manual cleaning because they cannot withstand either the high mechanical pressure of the water jet, the use of salts and chemicals, the prevailing temperatures in a dishwasher or the length of time they will be in contact with water.</i>		Nicht Backofengeeignet <i>Not oven safe</i>	Bestimmte Materialien verändern sich bei Temperaturen wie sie in Backöfen typisch sind. Diese können nicht im Backofen eingesetzt werden. Insbesondere schließt dies den Einsatz von Kunststoffen in der Regel aus. <i>Certain materials change at typical temperatures used for ovens. These cannot be used in ovens. In general this applies to most plastics.</i>
	Waschbar bis 30°C <i>Washable up to 30°C</i>	Maximal zu verwendende Waschtemperatur. <i>Maximum washing temperature to be used.</i>		Mikrowellengeeignet <i>Microwave safe</i>	Die Bedienungsanleitung der Geräte ist immer zu beachten, insbesondere darf nur ein Geschirr in der Mitte des Garraums mit ausreichendem Abstand zur Wand platziert werden. Auf metallische Geschirre sollte wegen Funkenflugs verzichtet werden. <i>Always check the operating instructions for appliances. Generally only one dish and cover may be placed in the centre of the microwave at a sufficient distance from the walls. Metal item's should not be used in microwaves.</i>
	Waschbar bis 40°C <i>Washable up to 40°C</i>	Maximal zu verwendende Waschtemperatur. <i>Maximum washing temperature to be used.</i>		Nicht mikrowellengeeignet <i>Not microwave safe</i>	Bestimmte Materialien sind nicht für die Mikrowelle geeignet. <i>Certain materials are not suitable for use in microwaves.</i>
	Waschbar bis 60°C <i>Washable up to 60°C</i>	Maximal zu verwendende Waschtemperatur. <i>Maximum washing temperature to be used.</i>		Lebensmittelgeeignet <i>Food safe</i>	Dieses Produkt ist durch die Auswahl seiner Materialien und der Art seiner Verarbeitung für den direkten Kontakt mit Lebensmitteln zugelassen. Anmerkung: in diesem Katalog nur angegeben, falls dies nicht selbstverständlich ist. <i>This product is suitable for direct contact with food due to the choice of materials and the way in which it is processed. Note: Only indicated in this catalogue if this is not obvious.</i>
	Waschbar bis 90°C <i>Washable up to 90°C</i>	Maximal zu verwendende Waschtemperatur. <i>Maximum washing temperature to be used.</i>		Graduiert <i>Graduated</i>	Dieser Artikel ist markiert mit einer schrittweise Einteilung des Volumens. <i>This item's capacity is shown in graduations.</i>
	Handwäsche <i>Hand wash</i>	Bei der Faser ist eine Handreinigung empfohlen. <i>Manual cleaning of this fibre is recommended.</i>		Kühlbar <i>Chillable</i>	Dieses Produkt ist mit einer passiven Kühlung mit einem Kühlakku versehen oder dafür vorbereitet. Je nach Umgebungstemperatur und Kühllast können Lebensmittel oder Getränke so länger frisch gehalten werden. <i>This product is provided with or prepared for passive chilling with ice packs. Depending on the environmental temperature, food or beverages can be kept fresh and cool.</i>
	Für alle Herdarten <i>All Cooking Methods</i>	Dieses Kochgeschirr kann auf allen Herdarten eingesetzt werden: Glaskeramik (Ceran®), Elektro, Gas und auch auf Induktionsfeldern. <i>This cookware is suitable for any cooking method such as glass ceramic (Ceran®), electric, including induction or gas.</i>		Wetterfest <i>Weatherproof</i>	Dieses Produkt kann unterschiedlichen Witterungsbedingungen ausgesetzt werden. <i>This product can be exposed to different weather conditions.</i>
	Für 3 Herdarten <i>3 Cooking Methods</i>	Dieses Kochgeschirr ist nur für Glaskeramik (Ceran®), Elektro- und Gasherde geeignet, nicht aber für Induktionskochstellen. <i>This cookware is suitable for cooking using glass ceramic (Ceran®), electric or gas but not induction.</i>		Wasserfest <i>Water proof</i>	Dieses Produkt löst sich unter Wasser nicht auf. <i>This product does not dissolve under water.</i>
	Ceran® Ceramic	Glaskeramikfelder sind auch als Ceran®-Felder bekannt. Die harten Glasoberflächen lassen sich leichter reinigen als herkömmliche Eisenherdplatten. Zum Reinigen benötigen Sie einen Glasschaber und entsprechende Reinigungsmittel. <i>Ceramic hobs - known as Ceran® fields - have hard glass surfaces that are easier to clean than conventional iron hotplates. Use a glass scraper and appropriate cleaning materials.</i>		Stapelbar <i>Stackable</i>	Das Produkt lässt sich durch seine Formgebung übereinander standfest stapeln. <i>Thanks to their shape, these products can be stacked on top of each other in a stable manner.</i>
	Elektro <i>Electro</i>	Elektrokochstellen sind die klassische Herdart in der Gastronomie. Wegen der hohen Vor- und Nachheizzeit werden sie heute immer häufiger durch die Induktionstechnik ersetzt. <i>Electric hobs are a classic cooking method. Due to the time they take to heat up and cool down, they are increasingly being replaced by induction technology.</i>			

Hinweise: Anwendung/Eigenschaften Notes: Application/Properties

Icon Icon	Anwendung/Eigenschaft Application/Property	Bemerkung Note
	Magnetisch <i>Magnetic</i>	Das bei diesem Produkt verwendete Material ist magnetisch und kann in Kombination mit dafür vorgesehenen Gerätschaften verwendet werden. <i>The material used in this product is magnetic and can be used in combination with matching equipment.</i>
	Klappbar <i>Foldable</i>	Dieser Artikel lässt sich manuell öffnen und platzsparend wieder schließen. <i>This article can be folded to save space.</i>
	Rutschfest <i>Non-Slip</i>	Die Oberfläche des Produktes ist so beschaffen, dass sie eine rutschhemmende Wirkung auf das zu transportierende Gut hat. <i>The surface of the product is designed in such a way that it has a non-slip effect on the goods to be transported.</i>
	Bruchsicher <i>Virtually unbreakable</i>	Dieses Produkt zeichnet sich dadurch aus, dass es unter normalen Arbeitsbedingungen nicht bricht. <i>This product is characterised by the fact that it does not break under normal working conditions.</i>
	Bisphenolfrei <i>BPA free</i>	Dieses Produkt ist frei vom Schadstoff Bisphenol A. <i>This product contains no bisphenol A.</i>
	Selbstlöschend <i>Self extinguishing</i>	Dieser Behälter ist durch seine Formgebung selbstlöschend. <i>This item is designed to cause any flames in it to self extinguish.</i>
	Sandwichboden <i>Sandwich base</i>	Mehrschichtboden aus Edelstahl mit einem Aluminiumkern, der an den Rändern offen liegt. Der Boden leitet und verteilt die Hitze optimal. <i>A visible aluminium core sandwiched between at least two layers of stainless steel resulting in a base that conducts and distributes heat evenly.</i>
	Kapselboden <i>Encapsulated base</i>	Eine erweiterte Form des Sandwichbodens, bei dem der Aluminiumkern komplett durch Edelstahl eingeschlossen ist. <i>A further type of sandwich base where the aluminium core is completely covered by a stainless steel layer.</i>
	Mehrschicht <i>Multi layered</i>	Dieses Material hat den gleichen Aufbau wie ein Sandwichboden; die äußere Schicht geht aber direkt in die Topfwand über. Verteilt die Hitze auch in der Wand gleichmäßig. <i>This material has a similar structure to a sandwich base throughout the whole of the pot or pan, thereby spreading the heat up the sides as well as the base.</i>
	HACCP	Das HACCP (Hazard Analysis and Critical Control Points) Konzept dient der Risikovermeidung und Qualitätssicherung im Bereich Lebensmittelhygiene in gewerblichen Umgebungen. <i>The HACCP (Hazard Analysis and Critical Control Points) concept describes risk prevention and quality control relating to food hygiene in professional environments.</i>
	GastroNorm <i>Gastronorm</i>	Die GastroNorm-Maße der DIN 66075 bzw. EuroNorm 631-1 beziehen sich auf den Referenzbehälter 1/1 mit der Größe 530 x 325 mm. <i>The Gastronorm dimensions of EN 631-1 refer to the full size GN 1/1 measuring 530 x 325 mm.</i>
	EuroNorm <i>Euronorm</i>	Die Euronorm definiert bestimmte einheitliche Tablettgrößen für die gewerbliche Nutzung. <i>The European standard defines certain standard tray sizes for commercial use.</i>
	Made in Germany	Dieses Produkt wird vollständig in Deutschland hergestellt. <i>This product is completely made in Germany.</i>
	Solingen	Dieses Produkt wird in der Klingentadt Solingen gefertigt. <i>Made in Solingen, the centre of the German knife industry.</i>
	Weck®	Fertigt von Weck, einem traditionsreichen deutschen Glashersteller. <i>Made by Weck, a traditional German glass manufacturer.</i>

Icon Icon	Anwendung/Eigenschaft Application/Property	Bemerkung Note
	Selbstmontage <i>Self assembly</i>	Der Artikel wird nicht vormontiert geliefert und muss vom Empfänger zusammengebaut werden. <i>This product is supplied flat packed.</i>
	Übergröße <i>Oversize</i>	Die Ware überschreitet zulässige Paketmaße und verursacht hierdurch höhere Frachtkosten. <i>These goods exceed permissible package dimensions and will therefore result in higher freight costs.</i>
	Per Spedition <i>By haulier</i>	Der Artikel ist zu sperrig oder zu schwer für den Paketversand und verursacht hierdurch erhöhte Frachtkosten. <i>The item is too bulky or too heavy for parcel carriers and will therefore result in higher freight costs.</i>
	Ätzen <i>Etching</i>	Auf dem Artikel kann ein Logo oder Schriftzug im Ätzerfahren aufgebracht werden. <i>This article can be etched with a logo or lettering.</i>
	Lasermarkierung <i>Laser etching</i>	Auf dem Artikel kann ein Logo oder Schriftzug im Ätzerfahren aufgebracht werden. <i>A logo or lettering can be applied to this article using a laser process.</i>
	Folierung <i>Skin packaging</i>	Der Artikel kann in Kundenaufmachung verpackt werden. <i>This article can be private label skin packed.</i>

A

Abdeckhauben	322
Abfallbehälter	488, 514-517
Abfallbehälter, Tisch-	508-509
Abfallgreifer	510
Abfalltonnen	488, 515-517
Abfüllhilfen	88-96, 161-162
Abfülltrichter	95
Abgrenzungsstände	460-461
Ablagegestelle	495
Ablagegestelle, Gastronorm	43-44, 495
Ablagen, Backblech-	125
Ablagen, Gepäck-	458-459
Ablagen, Tablett-	459
Ablaufkästen	227
Ablaufsiebe	502
Abräumwagen	488
Abreißgeräte	69
Abrollgeräte	69
Abschlagrollen	386
Absperrpfosten	460-461
Abstreichbehälter	280
Abtauplatten	51
Abteilplatten	340
Abtropfbleche, Gastronorm	42
Abtropfkästen	439
Abtropfschüsseln	81-82
Abwiegeschaufeln	89
Abziehstähe	120
Abziehsteine	121
Allergen-Thermometer	422
Allzweckwagen	61
Aluminiumgusspfannen	20-22
Anrührschüssel	78-79
Antihaft-Backformen	222-224, 229
Antihaft-Bratpfannen	4, 8, 20-24
Antirutschmatten	436
Apfelentkerner	139, 144
Apfelschälgeräte	107
Apfelschneider	447
Apfelteiler	144
Aräometer	263
Arbeitsschutz	417, 518-521
Aschenbecher, Tisch-	512-513
Aschenbecherpinsel	513
Aschenbehälter	513
Aspikformen	241
Aufbewahrung	51-98
Auffangbecken	61
Aufhängeleisten	173, 195-196
Auflaufformen	50
Aufschnittgabeln	170-171, 213, 299

Aufschnittplatten	51, 319-320
Aufschnittzangen	192
Aufsteller	470-472
Aufstrichmesser	356
Ausbeinmesser	109-113
Ausgießerbürsten	505
Ausgussbecken	502
Ausgussiebe	81-82
Auslageplatten	321
Auslageschalen	50-51, 320
Auslagentablets	51, 319-320
Aussteckerformen	265-269
Ausstelltablets	319-320
Austernbedarf	211

B

Backbleche	228-229
Bäckerei & Konditorei	216-286
Bäckermesser	279
Backförmchen	225-226
Backformen	238-248
Backformen, Antihaft-	222-224, 229
Backformen, Silikon-	230-237
Backgabeln	170-171, 213, 299
Backhandschuhe	521
Backkugeln	263
Backlineale	263
Backmatten	230-237
Backmulden	16, 22
Backschaufeln	161-162
Backzubehör	262-264, 506
Baguettekörbe	403
Bain-Marie-Einsätze	62-63
Bain-Marie-Schüsseln	270
Bain-Marie-Töpfe	289
Bankettplatten	208
Barcaddys	449
Barlöffel	453
Barmaße	450
Barmatten	456
Barregale	456
Barsiebe	446
Barzangen	432
Becher, Trink-	437
Becherförmchen	247
Becken, Vielzweck-	61
Behälter, Vorrats-	65-66
Beilageschalen	337-338, 341
Beile, Hack-	128, 201
Berlinertüllen	261
Berlinerwender	250
Besteck ATLANTIC	348
Besteck CAMPUS	349

Besteck EVENT	352	Bräter	19, 22, 30
Besteck ISABELLA	350	Bratpfannen, Edelstahl-	4, 8, 11, 19
Besteck LOUISA	344	Bratpfannen, Kupfer-	19
Besteck LUNA	342	Bratpfannen, rechteckige	16, 22
Besteck SANTORINI	346	Bratzangen	184, 187
Besteck SOPHIE	353	Brauseschläuche	500
Besteckbehälter	494-495	Brennbehälter, Chafing Dish-	291
Bestecke	342-357, 365, 368	Brennpasten	291
Bestecke, Edelstahl 18/0	348-353	Brezelständer	311
Bestecke, Edelstahl 18/10	342-347	Bridiernadeln	133
Bestecke, Kinder-	347	Briocheformen	223, 226, 230
Besteckhalter	389, 409, 493	Brötchendrucker	252
Besteckkästen	494-495	Brötchenkörbe	407
Besteckköcher	493	Brötchenmesser	110, 114
Besteckmulden	495	Brötchenschütten	402
Bestecksammler	488	Brotdrucker	250
Besteckspülkörbe	122, 492	Brotkörbe	404
Beutelverschluss	68	Brotmesser	110-113
Bierbedarf	436, 439-440	Brotaschen	407
Biergläser, Kunststoff	438	Brottschneidegeräte	107
Bierglasträger	394, 436	Brotzangen	192
Bierleitungsreiniger	440	Buchstabenleisten	472
Biermarken	439	Buffet & Event	288-322
Bierschaumabstreifer	439	Buffet- und Bankettplatten	316-319
Bierwärmer	439	Buffetdispenser	306
Biskuitförmchen	225	Buffetkörbe	402
Bistro-Schürzen	417	Buffetkühlsysteme	304-305
Bitterflaschen	450	Buffet-Modulsystem	314-315
Blechablagen	217	Buffetplatten	208
Bleche, Back-	228-229	Buffetpyramiden	306
Bleche, Konvektomaten-	41	Buffetständer	305, 308-309
Blechkuchenheber	278	Bullettenpresse	126-127
Blinispfannen	24, 27-29	Bundformen	224
Blockmessser	113	Buntschneidemesser	110, 140
Blumenvasen	415	Burgerbedarf	127
Bodenpaletten	500	Bürsten	504-507
Bonleisten	419	Bürsten, Kratzer, Schwämme	504-510
Bonschienen	419	Butterdosen	368
Bonspieße	419	Butterkühlschalen	212
Boston-Shaker	445	Buttermesser	356, 368
Bouillonkellen	156	Butterpfännchen	368
Bouillontassen	334	Butterroller	356
Bowlekübel	424-425	Butterschalen	368
Braisièren	16, 22		
Bratengabeln	173	C	
Bratenplatten	316	Caipi-Cap® Rührkappe	448
Bratensaftspritzen	133	Caipirinha-Stößel	448
Bratenschnüre	134	Cappuccinotassen	387
Bratenspachteln	180-181	Cassata-Eisformen	286
Bratenthermometer	420	Chafing Dish-Brennpasten	291
Bratentöpfe	3, 7, 10-11	Chafing Dishes	288-289
Bratenwender	176-180, 219	Chafing Dish-Heizungen	292
Bratenzubereitung	133	Chafing Dish-Zubehör	290

Chafing-Dish-Löffel	296
Champagnerkühler	424-425
Chilischäler	144
Cobbler	445
Cocktail-Utensilien	445-456
Cocottes	329
Confiserie-Paletten	257
Cornetformen	261
Couvertüregeräte	270
Crème brûlée-Brenner	262
Crèmerollenformen	261
Crêpes-Pfannen	27
Croissant-Schneider	269
Currywurstschalen	329
Currywurstschneider	107

D

Dach-Aufsteller	471
Dämpfeinsätze	13
Dampfgarkörbe	14-15
Dampfkochaufsätze	14
Dariol- und Puddingformen	247-248
Deckelablagen, Chafing-Dish	290
Deckelhalter	495
Deckelöffner	206-207
Degustationsbehälter	431
Dekantierständer	430
Dekorierlöffel	272
Dekoriermesser	139
Dekorierschneider	144
Dessertschalen	282
Dichtemesser	263
Digitales Thermometer	422
Dip-Schalen-Bretter	326
Dispenser	70-75
Dönermesser	109
Dönerschaufeln	162
Donut-Ausstecher	269
Donutformen	222
Doppelmaße, Cocktail-	450
Dosen	62-69
Dosenlocher	207
Dosenöffner	206-207
Dosierflaschen	72
Dosierschaufeln	90
Dosierspender	73-74
Drahtbürsten	507
Drahtkörbe, Gastronorm	42
Drahtpinsel	258
Dreieck-Garnierschneider	138
Dressiernadeln	133
Dressiersäcke	259
Dressingbehälter	66

Dressinglöffel	156, 167
Dressingschöpfer	156
Dressingspender	73-74
Drucksprühgeräte	503
Dünster	14-15
Durchschläge	81-82

E

Eier- und Tomatenschneider	147-148
Eierbecher	369
Eiereinsätze, Chafing Dish-	290
Eierköpfer	148
Eierkörbe	403
Eierlagerung	67-68
Eierlöffel	356, 365
Eierringe	148
Eierschneider	147
Eierstecher	148
Eierstückler	148
Eiertrenner	148
Eimer	58-60, 517
Eimer, zylindrische	56
Einkochgläser	371
Einmachtrichter	96
Einsätze für Teigwaren	14
Einsätze, Bain-Marie-	62-63
Einschubleche	41
Einstech-Thermometer	422
Einwegkapseln	262
Eisbearbeitung	91, 443-444
Eisbecher	281-282
Eisbombenformen	286
Eiscafé	281-284
Eischneebesen	152-153
Eiscremeformen	286
Eisdipper	285
Eiseimer	441-442
Eishämmer	443
Eishörnchenständer	284, 315
Eiskelche	281
Eislöffel	282-283
Eismühlen	443
Eispickel	443
Eisportionierer	285
Eisschalen	282
Eisschaufeln	91, 444
Eisskulpturformen	214
Eisspateln	282, 285
Eistütenhalter	284, 315
Eiswürfelbehälter	441-442
Eiswürfelformen	443
Eiszangen	444
Eiszerkleinerung	443

Entkerner	144	Fleischmulden	50-51, 241
Entkorkmaschinen	432	Fleischspieße	131-132
Entschupper	209	Fleischtöpfe	3, 7, 10
Entsteiner	107	Fleischwölfe	126
EPP-Thermoboxen	484-485	Flossenscheren	137
Escargot-Pfannen	213	Flötenkessel	14
Espressotassen	387	Folienschneider	431
Essenträger, Bain-Marie-	62-63	Fondantgeräte	272-273
Essenträger, Etagen-	63	Fondantglätter	256
Etagen-Tortenständer	275	Fondanttrichter	273
Etageren	310-311	Förtchenpfannen	30
Etikettenspender	69	Foyerascher	511
Euterspender	70-71	Frikadellenpressen	126-127
F		Frischhaltedosen	65-66
Fadenhobeln	104	Fritteusenthermometer	420
Fadenschneider	203, 447	Frittierkörbe	324
Falafel-Portionierer	132	Frittierschaufeln	160
Fassbierböcke	440	Fruchtdekorierermesser	138
Fasstrichter	95	Früchtekörbe	406
Fettschaufeln	161-162	Frühstücksmenagen	378
Fettseier	81	G	
Fett-Trennkannen	94	Gabeln	170-173, 213
Fischbackschaufeln	174	Gänsebräter	19, 22, 30
Fischbearbeitung	209	Garniermesser	110, 140
Fischantschupper	209	Garnierschneider	145
Fischfiliermesser	108	Gärschalen	404
Fischgrätenpinzetten	209	Gasbrenner	262, 291
Fischkochkessel	16	Gastronorm	35-49
Fischpfannen, ovale	22-23, 29	Gastronorm-Behälter, Edelstahl-	35-40
Fischplatten	208	Gastronorm-Behälter, Melamin-	47
Fischschaufeln	158	Gastronorm-Behälter, Polycarbonat- ..	48-49
Fischscheren	137	Gastronorm-Behälter, Polypropylen- ...	45-47
Fischwender	177	Gastronorm-Drahtkörbe	42
Fischzangen	188	Gastronorm-Einlegeböden	39, 49
Flair-Bottles	446	Gastronorm-Einschübe	42
Flambierpfannen	18	Gastronorm-Gitterroste	42
Flammkuchenbretter	313	Gastronorm-Halterungen	43-44, 495
Flaschenanhänger	472	Gastronorm-Konvektomatenbleche ...	41
Flaschenausgießer, undosiert	451-452	Gastronorm-Rahmen	42, 304
Flaschenausgießerbürsten	505	Gastronorm-Tablets	321
Flaschenhalterungen	455	Gastronorm-Zubehör	42-44, 304, 495
Flaschenkühler	305, 427	Gastronorm-Zwischenstege	43
Flaschenöffner	434-435	Gazesiebe	83
Flaschenregale	430	Gebäckpressen	262
Flaschenverschlüsse	435	Gebäckzangen	193
Fleischbearbeitung	126-137	Gedeckter Tisch	309, 324-380
Fleischbecken	50-51, 241	Geflügelscheren	136
Fleischerbeil	128, 201	Gefrierdosen	65-66
Fleischgabeln	171, 295	Geldkassetten	418
Fleischhaken	128	Gemüsedämpfeinsätze	13
Fleischklopfer	130	Gemüsehobeln	104
Fleischmesser	109, 113	Gemüselöffel	166

Gemüsemesser	110, 113
Gemüseschäler	142
Gemüseschneider	143-145
Gepäckablagen	459
Gepäckkarren	459
Geschirrhalter	495-498
Geschirrkörbe	490-492
Geschirrspülbrausen	501
Geschirrspülkörbe	122, 490-492
Geschirrtücher	505
Geschirrwannen	500
Getränke & Bar	424-456
Getränkebehälter	57
Getränkebuffet	305
Getränkekannen	305
Gewürzdosen	96
Gewürzkästen	64, 449
Gewürzkugeln	15
Gewürzreiben	101-103
Gewürzstreuer	96-97
Gießlöffel	159, 166
Gitterschneider	251
Gitterteigstanzen	251
Gläserabtropfmatten	456
Gläsereinsätze	499
Gläserkästen	499
Gläserregale	439
Gläserspülgeräte	504
Gläsertücher	505
Glaskaraffen	305
Glasschalen	308-309
Glasträger	436
Granitsplit	290
Grapefruitmesser	202, 447
Gratinbackformen	50, 337
Grillbürsten	507
Grillgabeln	135, 173
Grillpfannen	28-30
Grillreiniger	507
Grillroste	42
Grillwender	176
Grillzangen	135, 186-187
Grillzubehör	134-135, 186
Grissini-Körbe	406
Großküchensiebe	85
Grubentücher	505
Gugelhupfformen	226, 230
Gurkenhobeln	104
Gurkenschneider	139
Gurkenzangen	188
Gusseiserne Pfannen	28-30
Gyrosmesser	109
Gyrosschaufeln	162

H

Hackbeile	128, 201
Hackblockbürsten	129
Hackblöcke	129, 312
Hackfleischbedarf	126-127, 132
Hahnreinigungspumpen	440
Halbkugelschalen	242
Halter, Schneidbrett-	125
Hamburgerpressen	126-127
Hammerschlag-Kochgeschirre	19
Handschaufeln	88-90
Handschuhe, Gemüseputz-	103
Handschuhe, mechanischer Schutz ...	520
Handschuhe, thermischer Schutz	520-521
Handschuhstraffer	519
Handwaschbecken	502
Hängeleisten	173, 195-196
Hauben, Frischhalte-	321-322
Hebelkorkenzieher	433
Heber und Wender	174-183
Heizplatten	292
Heringszangen	188
Herzbackformen	223
Hinweisschilder	463, 469
Hobel, Gemüse-	104
Holzhämmer	440
Holzkästen	312
Holzschneidbretter	312-313, 326
Holzunterteller	31
Honigspender	370
Honigstäbe	370
Hörnchenschneider	269
Hot-Dog-Ablagen	410
Hotelbedarf	458-463
Hotelschlüsselanhänger	463
Hummerbedarf	210
Hummerplatten	208

I

Infrarot-Thermometer	422
Ingwerreibe	103
Irish-Coffee-Tassen	387
Isolierkannen	385
Isolierkannenschwämme	506
Isolierte Transportbehälter	482-483

J

Jigger	450
Jugendschutzgesetz	469
Juicer	146, 307
Julienneschneider	139

K

Kaffeekännchen, isolierte	384	Kellen, Schaum-	158
Kaffeekannen	380-383	Kellnerbedarf	417-419
Kaffeemaße	386-387	Kellnermesser	432-433
Kaffeportionierer	386	Kerzenhalter	415-416
Kaffeersatz-Laden	386	Kerzenlöscher	416
Kaffeetassen, doppelwandige	386-387	Kessel, Schneeschlag-	78
Kaffezubehör	386-387	Kessel, Wasser-	14
Kaisersemmeldrucker	252	Kesselbesen	152
Kältehandschuhe	520	Kesselgabeln	173
Kammschaber	256	Kesselschaber	256
Kandelaber	415-416	Kesselschaufeln	161
Kandiergitter	227	Ketchupspender	71-72
Kandisdosen	372	Kettenhandschuhe	519
Kannen	380-385	Kinderbesteck ME!First	347
Kannen Serie 100	381	Kippbratpfannenschaufeln	175
Kannen Serie 3000	380	Klappboxen	499
Kannen Serie 301	382	Kleidertransportwagen	458
Kannen Serie 501	383	Kleinmesser	114
Kannen, isolierte	384	Klemmbretter	480
Kannen, Mess-	92-94	Klemmleiste	419
Kannen, Transport-	55	Knoblauchbearbeitung	143
Kannenkennzeichnung	384	Knoblauchpressen	143
Kantinentablets	390-393	Knochensägen	128
Kapselheber	434-435	Knöpflehobeln	149
Karaffenbürsten	506	Köcher, Besteck-	493
Karaffenstände	430	Kochgeschirre	2-33
Karamellisierer	262	Kochlöffel	253
Kartenhalter	476-479	Kochlöffel und Teigspatel	253-256
Kartenhalterröhre	478	Kochmesser	108, 111-112
Kartoffelformlöffel	140	Kochpinzetten	185
Kartoffelkochkessel	12	Kochtöpfe, Aluminium-	13
Kartoffelpressen	149-150	Kochtöpfe, Edelstahl-	2, 5-11, 19
Kartoffelreiben	101	Kochtopfserie 2000	9-11
Kartoffelspiralen	144	Kochtopfserie 2100	2-5
Kartoffelstampfer	150	Kochtopfserie 2200	6-8
Käseglocken	303	Kofferablagen	459
Käsehobeln	118, 141, 202, 303	Konditorei	274-280
Käsekuchenformen	223	Konditormesser	279
Käsemesser	115-116, 356	Konditorpaletten	257
Käseplatten	303	Konferenzflaschenkühler	305
Käsepräsentation	303	Konfiserie	270-273
Käsereiben	101	Konservendosen	329
Käseschneidegeräte	118	Konservenöffner	206-207
Käseschneidemesser	115-118, 202	Konvektomatenbleche	41
Kassenbonspieße	419	Körbe	402-409
Kassenschlüsselketten	418	Körbe, Edelstahl-	405-406
Kasserollen	3, 7, 10, 18-19	Körbe, Natur-	402-404
Kästen, Gewürz-	64, 449	Körbe, Papier-	514
Kastenformen	231, 240-241	Körbe, Polypropylen-	408-409, 493
Kaviarkühler	212	Korb-Etagere	403
Kehrschaufeln	510	Korkenzieher	432-433
		Korkuntersetzer	31
		Kotelettklopfer	130

Krautgabeln	204
Krauthobeln	104
Kreidemarker	473
Kronkorken-Auffangbehälter	435
Kronkorkenheber	434-435
Krückengabeln	171, 295
Kuchenbleche	228-229
Kuchenformen	230
Kuchengitter	227
Küchenhandschuhe	520-521
Kuchenheber	277-278
Küchenmaße	92-94
Kuchenschere	279
Küchenmesser	108-119, 140-141
Kuchenrahmen	244-245
Küchenschaukeln	88-90
Küchenscheren	137
Küchenschüsseln	76-78
Küchenwaagen	94
Küchenzangen	184
Kugelausstecher	139, 145, 203
Kugeln, Gewürz-	15
Kugelschneebesen	153
Kühlakkus	305, 483, 485
Kühlbeutel	483
Kühlboxen	483
Kühlschrankthermometer	421
Kühlsysteme	304-305
Kundenstopper	464
Kupferkochgeschirr	18-19
Kutterwagen	61

L

Lachsmesser	109
Lagerbecken	499
Lasagneformen	224
Latte-Macciato-Löffel	387
Leberkäsformen	241
Lederhandschuhe	520
LED-Tafeln	467
Légumieren	337-338, 341
Likörtrichter	273
Limettenpressen	448
Limolöffel-Halter	449
Litermaße	92-94
Locher, Dosen-	207
Lockenschneider	104
Löffelablagen	290
Lyoner-Pfannen	20, 23-27

M

Macaronformen	222
Magnet-Messerhalter	122

Maiskolbengabeln	134
Malerpaletten	315
Mandolinen	104
Markierstifte	473
Marmeladendosen	359-363
Marmeladengläser	309, 371
Marzipan-Modellierer	264
Maße, Küchen-	92-94
Meeresfruchtschalen	212
Meerestierbearbeitung	208-213
Mehlbürsten	506
Mehlschaukeln	88-90
Menagen	358-363, 378
Menagen 122	362
Menagen 1411	361
Menagen 2727	358
Menagen 444	360
Menagen 888	359
Mengmulden	60
Mensuren	92-94
Menübestecke	342-357
Messbecher	92-94
Messer, geschmiedete	111
Messerabstreichbehälter	280
Messerblöcke	121
Messerkörbe	122
Messermagnetleisten	122
Messerrolltaschen	122
Messerschärfer	121
Messerserie MEGOL	112-113
Messerwetzstähle	120
Messerszubehör	121-122
Messkannen	92-94
Messlöffelsatz	90
Milchhaufschäumer	387
Milchkannen	380-383
Milchkochtöpfe	5
Milchschaum-Thermometer	420
Milchtransportkannen	55
Mini-Cocotten	329
Mini-Einkaufskörbe	327
Mini-Holzpaletten	327
Minikochgeschirr, Edelstahl-	332-333
Minikochgeschirr, Eisenguss-	329
Minikochgeschirr, Kupfer-	330-331
Mini-Körbe und -becher	327-328
Mini-Saucentöpfe	328
Mini-Seiher	327
Mini-Serviergeschirr, Holz-	327
Mini-Spiralbesen	446
Mischmulden	60
Mixerschüsseln	77-78
Mixflaschen	72

Mönchkopfkäsehobel	303	Parmesanmühlen	367
Mörser	103	Parmesanreiben	101
Moscow-Mule-Becher	437	Partybestecke	357
Moulins	87	Passetout	87
Mousse-Ringe	246	Passevite	87
Mozzarellaschneider	105	Passiergeräte	87
Muffinformen	222	Passierhölzer	84-85
Muffinzangen	193	Passiersiebe	83-86
Mulden, Meng-	60	Passiertücher	84
Mülleimer	488, 515-517	Pastaeinsätze	14
Multiply-Kochgeschirr	11, 17-19	Pastakochtöpfe	13
Muschelbedarf	212	Pastazubehör	221
Muschelserviertöpfe	212	Pasteteneisen	263
Muskatnussreiben	101-103	Pastetenformen	239-240
Müslispender	306	Pâtisserie-Formen	243, 286
N		Pellkartoffelgabeln	170
Nestbacklöffel	161	Pellkartoffelschneider	147
Netzschaumlöffel	160	Pendelschäler	140-142
Netzstreuer	96-97	Personenleitsysteme	460-461
Nichtraucherschilder	468-469, 476	Petits-Fours	225
Nudelkochtöpfe	13	Petits-Fours-Etagere	310
Nudelmaschinen	221	Pfannen, Aluguss-	20-22
Nudelrollhölzer	249	Pfannen, Aluminium-	23-24
Nudeltopfeinsätze	14	Pfannen, Blinis-	24, 27-29
Nussknacker	264	Pfannen, Eisen-	27
Nussreiben	101-103	Pfannen, Eisenguss-	28-30
O		Pfannen, geschmiedete	25-26
Obsttortenformen	224	Pfannen, Lyoneser-	20, 23-27
Ofenbürsten	219	Pfannen, Servier-	338
Officemesser	110-113	Pfannenschaukeln	174-176
Ölfilterschaukeln	161	Pfannenspachteln	181
Olivenbestecke	357	Pfannenuntersetzer	31, 397
Olivenentsteiner	145	Pfannenwender	176-178, 299
Olivenlöffel	357	Pfeffermühlen	366-367
Ölkannen	221	Pfefferstreuer	96-97
Omelettepfannen	24, 27-30	Pflaumentsteiner	107
Omeletteringe	148	Pförtchenpfannen	30
Orangensaftpressen	146, 307	Pilzschneider	145
Orangenschäler	139	Pinzel	258
Orderleisten	419	Pinzetten	185
Ordnen und Hygiene	482-517	Pizzaballenbehälter	220
P		Pizzabedarf	216-220
Paellapfannen	5, 27	Pizzableche	216-217
Paella-Schieber	175	Pizzablechhalter	217
Paletten	257	Pizzabretter	313
Pampelmusenmesser	202, 447	Pizzaheber	219
Papierkörbe	514	Pizza-Igel	252
Parisiene-Ausstecher	140	Pizzamesser	355
Parmesandosens	359-363	Pizzaofenbürsten	219
Parmesanmesser	117	Pizzaschaukeln	218
		Pizzascheren	220
		Pizzaschneider	219-220
		Pizzascreens	217

Pizzazangen	218
Platten	314-322
Plattiereisen	130
Platzteller	397
Poffertjes-Pfannen	30
Polker	109-113
Pommes frites-Schalen	329
Pommes frites-Schaufeln	162
Pommes frites-Schneider	106
Pommes frites-Seiher	81
Pommes frites-Ständer	325
Portionierer	285
Portionsmilchspender	377
Portionsvorleger	166
Porzellanreiniger	503
Pralinenformen	271
Pralinengitter	270
Pralinentungkabeln	271
Präsentkörbe	403
Preistafeln	466
Pressen, Knoblauch-	143
Pressen, Zitrus-	146, 307
Puddingförmchen	247
Puddingformen	242
Pumpen	75
Pyramidenformen	242

Q

Quetschflaschen	71-72
Quiche- und Parfaitformen	238
Quirle	153, 446

R

Racettespachteln	181
Ragoutschälchen	247
Rahmen, Gastronorm	42, 304
Rahmkännchen	375-377, 380
Ramequin-Förmchen	247-248
Raucherutensilien	511-513
Ravioliausstecher	221
Rechauds	292
Rechauds, Butter-	368
Rechnungsmappen	418
Reduierpateln	175
Regalwagen	486
Rehrückenformen	224
Reiben	100-103
Reinigungscremes	503
Reinigungsgeräte und -mittel	75, 503
Reinigungsschaber	506-507
Reinigungsschwämme	506-507
Reinigungstücher	505
Reisränder	243

Reserviert-Aufsteller	475
Rettichschneider	144
Rettichspiralschneider	143
Revolvertaschen	417
Rezeption	461-463
Rezeptionsglocken	462
Rezeptionsklingeln	462
Riesenpfannen, Eisenguss-	32
Rindenbretter	313
Ringständer	78
Rodonformen	224
Rohkostreiben	100-102
Rollbecken	61
Rollbehälter	61
Rollbratenfaden	134
Rollgestell	489
Rollhölzer	249
Rolltaschen, Messer-	122
Roll-Top Chafing Dishes	288-289
Rolluntersätze	489, 492
Rollwagen	483
Rollwalzen	250
Rosettenbackformen	223
Roste, Gastronorm	42
Rouladenklammern	133
Rouladenringe	133
Rückstellprobenzubehör	69
Rührbesen	151-153
Rührkappen	448
Rührlöffel	253
Rührschüsseln	78-79
Rundsiebe	86
Rundtonnen	517
Russische Tassen	334

S

Sackschaufeln	89
Saftdispenser	306
Saftflaschen	305
Saftpressen	146, 307
Sägen	128
Sahne, Zucker, Honigspender	309, 370-377, 380
Sahnebereiter	262
Sahnegießer	375-377, 380
Salatbestecke	167-169, 294
Salatschalen	50, 340
Salatschleudern	80
Salatschneidegeräte	106
Salatzangen	191-192
Salz-/Pfeffermühlen	366-367
Salz-/Pfefferstreuer	363-365
Salz-/Zuckerumränder	449
Salzlöffel	356

Salzstreuer	96-97	Schöpfkellen	154-156, 294
Sammelbehälter	488	Schraubdeckelöffner	206-207
Sandkranzformen	224	Schreibtäfelchen	471
Santokumesser	108	Schreibtäfelblätter	472
Saucendispenser	73-74	Schuhlöffel	461
Sauceneinsätze	290	Schürzen	417, 519
Saucengießlöffel	159, 166	Schüsseln	76-78
Saucenkellen	159, 294	Schüsselständer	78
Saucenkuh®	70-71	Schüttgutschaufeln	90
Saucenpumpen	75	Schwenkkasserollen	5, 8, 11, 18
Saucentöpfe	5, 8, 11, 18	Sechseckreiben	100-102
Saucieren	339	Seiher	81-82
Sauteusen	5, 8, 11, 18	Seihlöffel	158
Sautoirs	3, 7, 10, 18-19	Sektflöten, Kunststoff	438
Savarinförmchen	243	Sektglasbürsten	506
Schalen, Brot-	407	Sektkühler	425-427
Schalen, rechteckige	50-51, 241	Sektkühlerständer	428-429
Schalenständer	308-309	Senflöfel	365
Schäler	142	Serie 188	195
Schälmesser	110-111	Serie BUFFET Noir	293-295
Schaschlikspieße	131-132	Serie BUFFET One	296-299
Schaufeln	88-90, 161-162	Serie CHEF TOOLS	138-141
Schaumkellen	158	Serie ERGONOM	300-302
Schaumlöffel	157-158, 161	Serie POLARIS	196-205
Schaumschläger	153	Serviceartikel	380-422
Schaumspeisenformen	246	Servier-Becher	328
Scheibenschneider	141	Servierbretter	303, 312-313, 326
Scheren	136-137	Servier-Eimer	328
Schiffchenformen	225	Servier-Eisenpfannen	25-26
Schillerlockenformen	261	Servier-Frittierkörbe	324
Schinkenhalter	114	Serviergeschirr, klassisch	334-341
Schinkenmesser	108, 112	Serviergeschirr, modern	324-333
Schirmständer	461	Servierkellen	156
Schlachthofwagen	61	Servierkörbe	404
Schlagmaschinenkessel	78	Servierlöffel	163-167, 198, 293
Schlauchbürsten	505	Servierpfannen	338
Schlüsselanhänger	463	Servierschalen, moderne	327-329
Schneckenbedarf	213	Servierschüsseln	77
Schneebesen	152-153, 446	Serviertablets, ovale	396
Schnees Schlagkessel	78	Serviertablets, runde	394-395
Schneidbretter	123-125	Servierwagen	487
Schneidbretthalter	125	Servierzangen	189-192, 295, 298
Schneidbretthobeln	125	Serviettenhalter	411-413
Schneidegeräte	105-107, 447	Serviettenringe	413
Schneidgitter, Gastronorm	43	Siebe und Seiher	81-87
Schnellkochtöpfe	12	Siebschaufeln	158
Schnittkuchenblech	229	Silikonbackmatten	231-234
Schnittschutzhandschuhe	518	Simmertöpfe	13
Schnitzmesser	141	Skirtingklammern	414
Schnüre	134	Snackablagen	410
Schokoladenhobeln	272	Snackschalen	341
Schokoladenspachtel	270	Solinger Messer, geschmiedete	108-110
Schöpfer	91	Sonderbestecke	356-357, 365

Soßenkuh	70-71	Steakpfannen	28-30
Soßenlöffel	159, 166	Stechschutzhandschuhe	519
Soßentöpfe	5, 8, 11, 18	Stechschutzhürzen	519
Sous-Vide-Trichter	95	Stellringe	78
Spachtel und Schaber	181	Stielkasserollen	3, 7, 10, 18-19
Spaghettiespressen	149-150	Stielsiebe	82
Spaghettiheber	182-183	Stikkenwagen	486
Spaghettitöpfe	13	Stipproller	252
Spaghettizangen	183	Store-and-Pour-Behälter	72
Spalter	128, 201	Stößel	84-85
Spargelkochtöpfe	7	Stövchen	292
Spargelschäler	140-142	Streuer	96-97
Spargelzangen	192-193	Strohalmbecher	389, 493
Sparschäler	140-142	Sülzkotelettformen	241
Spatel, Reduier-	175	Suppenkellen	154-156, 294
Spätzlepressen	149	Suppentassen	334
Speedbottles	450	Suppenteller	334
Speed-Flaschenöffner	434	Suppenterrine, elektrische	289
Speiseeis-Behälter	286	Suppenterrinen	335-337
Speisekartenmappen	479-480	Sushimatten	213
Speisekartenstöcke	480		
Speisenablagen	410	T	
Speisenbearbeitung	100-213	Tablettablagen	459
Speisentransportbehälter	54-61	Tablets	390-396, 436
Spender, Saucen-	73-74	Tafelbestecke	342-357, 368
Spezialformen	242	Tafeln	464-467, 472
Spezialtöpfe	5-7, 12-14	Tafelreiniger	473
Spickmesser	113	Tafelschwämme	473
Spicknadeln	133	Tarteletteformen	225-226
Spieße, Kassenbon-	419	Taschenhalter	414
Spiralbesen	153, 446	Tassen und Becher	437-438
Spiralschneider	143	Tassenhalter	496-498
Spirituosen-Dosierer	455	Teebeutelklammern	388
Spirituosenlineale	449	Teegläser	388
Spitzsiebe	83	Teekannen	381-383
Spitzsiebständer	273	Teesiebe	388
Springformen	223	Teesiebkugeln	15
Spritzausgießer	452	Teezubereitung	388
Spritzbeutel	259	Teig- und Pizzaschneider	219-220
Spritzbeutel und Zubehör	259-261	Teigbearbeitung	249-252
Spritzschutz	31	Teigkeifer	264
Spritztüllen	260-261	Teigmischer	251-252
Sprühgeräte	503	Teigräder	220
Sprühgeräte, lebensmittelgeeignet	75	Teigrollen	249-250
Spülkörbe	122, 490-492	Teigschaber	255-256
Spüllatzschürzen	519	Teigspateln	253-255
Staffeleien	466	Teigwareneinsätze	14
Standaschenbecher	511	Tellerclips	438
Ständer, Sektkühler-	428-429	Telleretageren	311
Standrohre	500	Tellerglocken	398-401
Standtafeln	466-467	Tellerschneebeesen	153
Stapelgestelle	309	Tellerwärmer	340
Steakbesteck	354-355	Terrinen, Suppen-	335-337

Terrinenformen	238, 241	Traubenscheren	137
Tête-de-Moine-Hobeln	303	Tretabfallbehälter	515-516
Thekenaufsteller	479	Trichter	95-96
Thermoboxen	482-483	Trinkbecher	437
Thermometer	420-422	Trinkhalmöffel	453
Thermometer-Clips	421	Trinkhalmständer	389, 449, 493
Thermosaucieren	339	Tropfbleche	439
Thermo-Transportbehälter	57	Tropfenfänger	431
Tiffin-Lunch-Boxen	63	Trüffelgitter	270
Timbalen	247-248	Trüffelhobeln	140, 143
Tischabfallbehälter	508-509	Tüllen	260-261
Tischaccessoires	411-416	Tüllenbürsten	505
Tischaufsteller	470-478	Tungkabeln	271
Tischbeschilderung	474-479	Türschilder	463, 468
Tischbestecke	342-357	Türsymbole	463, 468
Tischbürsten	509		
Tischglocken	462	U	
Tisch-Kreidetafeln	470	Universalbehälter	54
Tischnummern	474	Universalmesser	110
Tischschilder	474	Untersetzer	31, 397, 427
Tischstaffeleien	470	Unterziehhandschuhe	519
Tischtafeln	470-472		
Tischtuchklammern	414	V	
Toastständer	407	Vasen	415
Toastzangen	193	Verkaufschütten	410
Tomatenentstieler	139	Verschlussklammern	68
Tomatenmesser	110, 355	Vielzweckbecken	61
Tomatenschneider	105, 147	Vielzweckreiben	100-102
Topfeinsätze	14	Viertel-Einsätze	14
Topfkratzer	507	Vorlegelöffel	163-167, 198, 293
Topflappen	521	Vorlegezangen	189
Tortenhauben	276	Vorratsdosen	65-66
Tortenheber	277-278	Vorratskästen	67, 220
Tortenkämme	256	Vorratsstonnen	517
Tortenmesser	277-279		
Tortenmesserbehälter	280	W	
Tortenplatten	274-276	Waagen	94
Tortenrahmen	244-245	Wachspapiere	325
Tortenreliefmatten	245	Wagen	486-489, 492
Tortenringe	244-245	Wandaschenbecher	511
Tortenringpaletten	245	Wandkreidetafeln	471
Tortenscheiben	245	Wandtafeln	465-467, 472
Tortenteiler	278	Wannen	79
Tortenträger	276	Wannenwagen	61
Tortenunterlagen	245	Wärmesand	290
Tranchiergabeln	172	Warmhaltebehälter	482-485
Tranchiermesser	109-111, 114, 172	Warmhaltegeräte	288-292
Transportbehälter	54-61, 517	Warmhalteplatten	292
Transportbehälter, isolierte	57	Warmhaltesets	340
Transporteimer	56	Warnaufsteller	510
Transportkannen	55	Waschbecken	500-502
Transportkästen	495, 498	Wäschesammelwagen	459
Transportwagen	492	Wasserbadeinsätze	13

Wasserbadkasserollen	62-63	Zitrusfruchtmesser	202, 447
Wasserbadschüsseln	270	Zitruspressen	146, 307
Wasserkannen	380-383	Zucchiniausstecher	139
Wasserkessel	14	Zuckerblasebalge	263
Wechselfropfen	455	Zuckerdosen	372, 375-377
Wechselrahmen	467	Zuckerdosierer	373-374
Weck®-Gläser	305, 308-309, 415	Zuckerkugeln	372
Weichkäsehobeln	118	Zucker-Sahne-Sets	375-377
Wein- und Sektzubehör	424-433	Zuckerschalen	372
Weindekantierständer	430	Zuckerstreuer	96-97
Weinflaschenausgießer	431	Zuckerteller	372
Weinflaschenkühler	305, 427	Zuckerthermometer	263
Weinflaschenschalen	327	Zuckerwaagen	263
Weinflaschenständer	430	Zuckerzangen	373
Weinflaschenutensilien	431-432	Zutatenbehälter	449
Weingläser, Kunststoff	438	Zutatenbehälter, fahrbare	61
Weinkartenmappen	479-480	Zylinderbürsten	506
Weinkisten	499		
Weintafeln	466		
Weinthermometer	421		
Weintropfenfänger	431		
Wellenschneider	145		
Wender	178-180, 219		
Werben & Leiten	460-480		
Werbetafeln	464-467, 472		
Wetzstähle	120		
Wiegemesser	119		
Windaschenbecher	512		
Winkelpaletten	257		
Woklöffel	161		
Woks	17		
Wurstgarne	134		
Wurstmesser	109		
Wurstschneidegeräte	107		
Wurstzangen	186		
Y			
Y-Querschäler	142		
Z			
Zackenschaber	256		
Zahlteller	418		
Zangen	183-193, 213, 295		
Zapfhähne	440		
Zeitungsablagen	462		
Zeitungsstöcke	462		
Zesterreiben	103		
Ziegeleisformen	286		
Zigarrenbedarf	513		
Ziseliermesser	138		
Zitronenreiben	141		
Zitronenschaber	103		
Zitronenschnitzelpressen	146		



- A**
- Airpots 385
 - Aluminium Cookware 23-24
 - Aluminium Stock Pots 13
 - Analogue Thermometers 420-421
 - Apple Corers 139, 144
 - Apple Dividers 144
 - Apple Peelers 107
 - Aprons 519
 - Ashtrays 511-513
 - Asparagus Peelers 142
 - Asparagus Pots 7
 - Asparagus Tongs 192
 - Aspic Cutlet Moulds 241
- B**
- Bag Clips 68
 - Bailing Bowls 270
 - Bain Marie Containers 62-63
 - Baking Beans 263
 - Baking Dishes 50
 - Baking Mats 235
 - Baking Rulers 263
 - Baking Sheets 228-229
 - Bamboo Steamers 15
 - Bannetons 404
 - Bar Blades 434-435
 - Bar Knives 447
 - Bar Mats 456
 - Barbecue Slices 176
 - Barbecue Tongs 186-187
 - Barbecue Utensils 134-135
 - Barbeque Tongs 186-188
 - Barrier Posts 460-461
 - Basins 79
 - Baskets, polypropylene 408-409, 493
 - Basters 133
 - Basting Spoons 159
 - Beakers and Glasses 437-439
 - Beer Glass Trays 436
 - Beer Sundries 439-440
 - Bells 462
 - Beverage Buffet 305-306
 - Beverage Service 380-388
 - Bill Presenters 418
 - Bill Spikes and Rails 419
 - Birds Nest Fryers 161
 - Bistro Aprons 417
 - Black Iron Cookware 27
 - Blackboards 464-467
 - Blinis Pans 24, 27-29
 - Board Scrapers 125
 - Boiling Pots with Tap 12
 - Boning Knives 109-113
 - Bottle Coolers 305
 - Bottle Openers 434-435
 - Bowls 76-77
 - Bowls and Basins 76-79
 - Braising Pans 19
 - Bread Baskets, natural 402-404
 - Bread Knives 110-113
 - Bread Slicers 107
 - Bread Stamps 252
 - Brushes 505-507
 - Brushes and Scrapers 180-181, 505-507
 - Buckets 58-59, 517
 - Bud Vases 415
 - Buffet & Events 287-322
 - Buffet Boards 312-313
 - Buffet Display System 314-315
 - Buffet Noir 293-295
 - Buffet One 296-299
 - Buffet Pyramids 306
 - Buffet Trays 317-319
 - Burger Sundries 126-127, 132
 - Butchers Knives 112-113
 - Butchers Saws 128
 - Butcher's Trays 51
 - Butter Curlers 356
 - Butter Knives 356
 - Butter Service 356, 368
- C**
- Cake Knives 278-279
 - Cake Lifters 277-278
 - Cake Pop Moulds 235
 - Cake Slices 279
 - Cake Stands 274-276, 310-311
 - Cake Trays 229
 - Cake/Pie Lifters 277-278
 - Can Openers 206-207
 - Can Punches 207
 - Canapé Spoons, Forks 357
 - Candelabras 416
 - Candle Snuffers 416
 - Candlesticks 415-416
 - Canteen Trays 390-393
 - Carafes 305
 - Card and Menu Holders 475-480
 - Card Holders 475-478
 - Carving Forks 109, 171-172
 - Carving Knives 108-111, 114
 - Cash Boxes 418
 - Cassata Moulds 286
 - Casseroles 3, 7, 10, 19, 30

Cast Aluminium Cookware	20-22	Convection Oven Trays	41
Cast Iron Cookware	28-30	Cooks Knives	108, 111-112
Castors	489	Cookware 2000	9-11
Caviar Dishes	212	Cookware 2100	2-5
Cereal Dispensers	306	Cookware 2200	6-8
Chafing Dish Accessories	290-292	Cooling Racks	227
Chafing Dishes	288-289	Copper Cleaning Creams	503
Champagne Buckets	426-429	Copperware	18-19
Cheese Cutters	118	Cork Mats	31
Cheese Items	303	Corkscrews	432-433
Cheese Knives	115-116, 201	Cornet Stands	284, 315
Cheese Slicers	118, 141, 202	Corn-on-the-cob forks	134
Cheese Utensils	115-118, 201-202, 303	Courgette Cutters	139
Cheese Wires	118	Covers for Buffet	322
Chef's Blow Torches	262	Cranked Turners	179
Chefs Tongs	185	Cream Tube Moulds	261
Cherry Stoners	145	Cream Whippers	262
Children's Cutlery	347	Creamers	375-377
Chilli Knives	144	Crêpe Pans	27-29
Chinois	83, 273	Crêpe Tools	251
Chip Scoops	161-162	Crockery Carriers	489, 495-498
Chip Scuttles	42	Crumpers	509
Chip Sundries	325	Cucumber Slicers	139
Chocolate Equipment	270-273	Cut Resistant Gloves	518-519
Chocolate Shavers	272	Cutlery	342-357, 365
Chopping Blocks	129, 312	Cutlery, Stainless Steel 18/0	348-353
Churns	55	Cutlery, Stainless Steel 18/10	342-347
Cigar Cutters	513	Cutters, Pastry	219-220, 265-269
Citrus Presses	307	Cutting Board Racks	125
Citrus Squeezers	146	Cutting Boards	123-125
Citrus Wedgers	447		
Cleaning Devices and Substances	75, 503-504	D	
Clearing Trolleys	488	Dariol Moulds	247-248
Cleavers	128	Dariols and Pudding Basins	247-248
Cloths	505	Day of the Week Labels	69
Coasters	397	Deco Twisters	139
Cocktail Jiggers	72, 450	Decorating Combs	256
Cocktail Shakers	445-446	Decorating Knives	110, 141
Cocktail Spoons	453-454	Decorating Spoons	272
Cocktail Sundries	446-449	Deep Stock Pots	9
Coffee Accessories	386-387	Dicers	106
Coffee Portioners	386-387	Digital Thermometers	422
Colanders	81-82	Dishwasher Racks	490-492
Colanders and Strainers	80-87, 273	Display Trays	51, 319-320
Cold Buffet	304-306	Door Signs	468
Cold Crocks	74	Double Boilers	13
Cold Forged Cookware	25-26	Dough Cutters	251-252
Compression Sprays	75, 503	Dough Scrapers	255
Condiment Boxes	64, 449	Doughnut Turners	250
Condiment Dispensers	449	Drainer Plates	35-49, 495
Condiment Holder	71	Dressing Ladles	156
Condiments	358-365	Drinks & Barware	72, 124, 373, 421, 424-456, 505



Dustpans 510

E

Easels 466
 Egg Baskets 403
 Egg Boxes 67-68
 Egg Cups 369
 Egg Dividers 148
 Egg Lifters 177-178
 Egg Pans 30
 Egg Prickers 148
 Egg Rings 148
 Egg Separators 148
 Egg Slicers 147
 Egg Spoons 356, 365
 Egg Tools 147-148
 Egg Toppers 148
 EPP Insulated Boxes 484-485
 Ergonom Utensils 300-302

F

Fajita Towers 311
 Fast Food Trays 390-393
 Fat Separators 94
 Filleting Knives 108
 Fish and Seafood 164, 208-213
 Fish Kettles 16
 Fish Lifters 158
 Fish Pans 22-24, 29
 Fish Platters 208
 Fish Scalers 209
 Fish Scissors 137
 Fish Slices 176-177
 Fish Tongs 188
 Flambé Pans 18
 Flats 316
 Flats and Platters 51, 316-322
 Flexipan® Mats 236-237
 Floor Mats 500
 Flour Brushes 506
 Foil Dispensers 69
 Fondant Cutters 272
 Fondant Funnels 273
 Fondant Smoothers 256
 Food & Drink Carriers 56
 Food & Drink Handling 379-422
 Food Boxes 67-68
 Food Carriers 63
 Food Cleaning Gloves 103
 Food Preparation 99-213
 Food Storage Containers 51
 Food Warmers 292
 Freeflow Pourers 451-452

French Fries Sundries 325
 Fruit Baskets 405-406
 Fruit Decorators 138
 Frying Pans 4, 8, 11, 19-32
 Funnels 95-96

G

Garlic Presses 143
 Garlic Tools 143
 Garnishers 145
 Garnishing Cutters 144
 Garnishing Knives 110, 141
 Garnishing Tools 144-147
 Gastronorm 35-49
 Gastronorm 18/10 Stainless Steel 35-41
 Gastronorm Accessories 42-44, 495
 Gastronorm Buffet Trays 321
 Gastronorm Containers Polycarbonate 48-49
 Gastronorm Containers Polypropylene 45-47
 Gastronorm Trays 41
 Gift Baskets 403
 Glass Carriers 499
 Glass Washers 504
 Gloves 521
 GN Covers 322
 GN Holders 44, 495
 GN Portioners 43
 GN Separator Bars 43
 GN System Dividers 43
 GN Wooden Boxes 312
 Graduated Measures 92-94
 Grapefruit Knives 202
 Graters 100-103
 Gratin Pans 19
 Gravy Boats 339
 Gravy Spoons 159
 Greaseproof Paper 325
 Griddle Pans 22, 28-29
 Griddle Scrapers 181
 Griddles 26
 Grids 42
 Gugelhupf Moulds 224, 242

H

Hachoirs 119
 Ham Clamping Stands 114
 Ham Knives 112
 Hammered Cookware 19
 Hand Wash Basins 502
 Handbag Holders 414
 Handee Cheese Cutters 118
 Hanging Racks 173, 195-196
 Hemispherical Moulds 242

Honey and Sugar Sundries	370-377
Honey Sundries	370
Hot Dog Stands	410
Hotel	458-463
Hotel Luggage Trolleys	458

I

Ice Buckets	441-442
Ice Cream Moulds	286
Ice Cream Scoops	285
Ice Cream Sundries	281-286, 315, 397
Ice Crushers, Moulds	443
Ice Packs	304-305, 483
Ice Scoops	444
Ice Sculpture Moulds	214
Ice Tongs	373, 444
Insulated Beverage Servers	384-385
Insulated Boxes	482-483
Insulated Food and Drink Carriers	57

J

Jam Pots	371
Jar Openers	207
Juice Dispensers	306-307
Julienne Slicers	139

K

Kebab Catchers	162
Kebab Knives	109
Kettles	14
Kitchen and Carving Knives	114, 172
Knife Accessories	120-121
Knife Blocks	121
Knife Cleaners	280
Knife Racks	122
Knife Sharpeners	121
Knife Wallets	122
Knives	108-125, 355-356
Knock-Out Drawers	386

L

Label Dispensers	69
Ladles	154-159
Larding Needles	133
Large Iron Pans	32
Lasagne Tins	224
Latte spoons	387
Laundry Trolleys	459
LED Displays	467
Lemon Graters	141
Lettuce Cutters	106
Lifters	177-178
Lime Graters	103

Loaf Tins	240-241
Lobster Crackers	210
Luggage Racks	459

M

Mandolins	104
Marker Pens	473
Markers	252
Marzipan Tools	264
Measure Pourers	452
Measures	92-94
Measuring Spoons	90
Meat Forks	171-173, 295
Meat Hooks	128
Meat Preparation	126-137, 186
Meat Tenderisers	126, 130
Melon Ballers	139-140, 145, 203
Menu Boards	470-472
Menu Holders	476-480
Milk Frothers	387
Milk Pots	5
Mills	366-367
Mincers	126
Mini Cocottes	329
Mini Copper Pans	330-331
Mini Frying Baskets	324
Mini Presentation Pans	332-333
Mini Serving Dishes	222-224, 324-329
Mini Wooden Pallets	327
Mitts	520-521
Mixing Bowls	78-79
Mortars	103
Moulins	87
Mousse Rings and Frames	246
Mozzarella Cutters	105
Muddlers	448
Muffin Tongs	193
Multipurpose Containers	54
Multipurpose Trolleys	60-61
Mushroom Slicers	145
Mussels Pots	212
Mustard Spoons	365

N

Napkin Holders	411-413
Newspaper racks	462
No Smoking Signs	476
Non-Stick Bakeware	222-224, 229
Nut Crackers	264
Nut Graters	101-103
Nutmeg Mills	103



O	
Oil Cans	221
Omelette Pans	24
Orange Caneles	139
Other Cookware	12-13
Other Cutlery	356-357, 365
Oven Cloths	521
Oyster Dishes	211
Oyster Knives	211
P	
Paddle Boards	313
Paddles	253
Paella Pans	5, 27
Paella Slices	175
Palette Knives	257
Pan Grippers	218
Paring Knives	110, 113-114
Parmesan Cheese Mills	367
Parmesan Graters	101-103
Parmesan Knives	117
Parmesan Pots	359-363
Pasta Accessories	220-221
Pasta Baskets	14
Pasta Machines	221
Pastry & Baking	215-286
Pastry Accessories	262-264, 506
Pastry Brushes	258
Pastry Cutters	219-220, 265-269
Pastry Moulds	225-226
Pastry Rings	244-245
Pastry Servers	277
Pastry Sundries	251-252
Pastry Tongs	192-193
Pâté Moulds	240
Peelers	140-142
Peeling Knives	110-111
Perforated Scoops	158
Perforated Spoons	164, 293
Pestles	84-85
Piping Bags	259
Piping Bags and Tubes	259-261
Piping Tubes	260-261
Pizza Accessories	216-221
Pizza Dough Boxes	220
Pizza Knives	355
Pizza Pans	216-217
Pizza Peels	218-219
Plate Covers and Cloches	398-401
Plate Warmers	340
Plum and Cherry Stoners	107
Porcelain Cleaners	503
Potato Chippers	106
Potato Forks	170
Potato Mashers	150
Potato Slicers	147
Pots and Jugs	380-383
Poultry Shears	136
Pourers	451-452
Pre-Rinse Spray Units	500-501
Pressure Cookers	12
Pretzel Stands	311
Professional Cookware	2-32
Professional Garnishing Tools	138-145
Professional German Knives	108-110, 171-172
Professional Knives	111, 172
Professional Knives Megol	112-113
Protective Gloves	518-521
Pudding Basins	247
Pumps	75
Punch Bowls	424-425
Pyramid Moulds	242
Q	
Quiche Tins	238-241
R	
Radish Decorators	138
Ramekins	247
Ravioli Cutters	221
Reception	462-463
Reducing Spatulas	175
Retention Samples	69
Ring Moulds	224
Roasting Dishes	50
Roasting Pans	16, 22, 50-51
Roasting Racks	42
Roller Dockers	252
Rolling Pins	249-250
Room Key Fobs	463
Room Signs	463
Roti Rollers	250
Roulade Preparation	133
Round Steels	120
S	
Saccharometers	263
Salad Servers	168-169
Salad Spinners	80
Salad Tongs	190-192
Salmon Knives	109
Salmon Tweezers	209
Salt & Pepper Pots	364-365
Salt and Pepper Mills	366-367
Salt Spoons	356

Sandwich Knives	110, 356	Slices	174-177
Sandwich Stands	410	Slices and Lifters	174-180, 219
Santoku Knives	108	Slotted Serving Spoons	165
Sauce Boats	339	Slotted Slices	176, 179, 299
Sauce Bottles	71-72	Snack Dishes	341
Sauce Dispensers	70-72	Snail Forks	213
Sauce Dispensers with pump	73-75	Snail Pans	30
Sauce Ladles	156, 159, 294	Snail Sundries	213
Sauce Pans	3-4, 7, 10, 19	Soup Bowls	334
Sauce Warmers	13	Soup Ladles	154-156, 294, 297
Sauce/Gravy Ladles	159	Soup Tureens	335
Sausage Slicers	107	Sous Vide Funnels	95
Sauté Pans	3, 7, 10, 18	Spaghetti Lifters	182-183
Sauteuses	5, 8, 11, 18, 24	Spaghetti Servers	182-183
Savarin Moulds	243	Spaghetti Tongs	183
Scales	94	Spatulas	161, 181, 253-256
Scalloped Slicers	112	Spätzle Slicers	149
Scalloped Tongs	184	Special Moulds	242-243, 286
Scissors	137	Speed Pourer Sets	72, 450
Scoops	88-91, 444	Spiders	160
Scourers	507	Spiral Cutters	143-144
Scrapers	180-181, 506-507	Spirit Measures	455
Seafood Picks	210	Spittoons	431
Seafood Sundries	164, 212	Splatter Guards	31
Seafood Trays	212	Spoons	253
Service	380-422, 492-493	Spoons and Forks	163-173, 195-198, 204, 213, 295-296, 299
Service Plates	397	Spoons and Paddles	253-256
Service Trolleys	486-487	Steak Cutlery	354-355
Serviette Holders	411-413	Steamer Baskets	7, 14
Serving Boards	326	Steamer Inserts	14
Serving Dishes	337-338	Steamers and Infusers	15
Serving Forks	167, 170-173, 204, 213, 299	Stock Pots	2, 6
Serving Ladles	166	Storage Containers	65-66
Serving Pans	25-26	Strainers	82-85, 273
Serving Spoons	163-167, 198, 296	Straining Cloths	84
Serving Stand for Iron Pans	25	Strings	134
Serving Tongs	187-190, 295, 298	Sugar Bowls	372
Serving Trays	394-396	Sugar Bowls and Creamers	375-377
Shakers	96-97	Sugar Pourers	373-374
Shelves	42	Sugar Pumps	263
Shoe Horns	461	Sugar Thermometers	263
Sieves	86	Sugar Tongs	373
Signage	464-480	Sundae Cups	281-282, 397
Signs	469	Sundae Spoons	282-283
Silicone Bakeware	230-243	Sushi Mats	213
Silicone Moulds	230-234	Sushi Tongs	185
Sink Strainers	502		
Sinks & Wash Basins	500-502		
Skewers	131-132	T	
Skimmers	157-158, 195	Table Cloth Clips	414
Skimmers and Ladles	154-162, 195	Table Numbers & Signs	474-475
Slicers	105-107, 112	Table Top Waste Bins	508-509



Tableware	324-377
Tableware Accessories	414-416
Tasting Ladles	156, 159, 294
Tea Infusers	15
Tea Sundries	388
Tealight Holders	415
Terrine Moulds	238-239
Tête-de-Moine Cheese Slicers	303
Thermometers	420-422
Timbales	247-248
Tins	222-224, 329
Tip Trays	397, 418
Toast Racks	407
Toilet Seat Covers	463
Tomato Knives	110, 140, 355
Tomato Slicers	105, 147
Tomato Stalk Removers	139
Tongs	184-194, 295, 298
Transportation & Cleaning	75, 180-181, 389, 449, 482-521
Trivet Plates	12, 39-40
Trivets & Mats	31
Trolleys	486-489, 495
Truffle Mandolins	140, 143
Trussing Needles	133
Tubular Handled Utensils	196-207
Turners	178-180, 219
Tweezers	185

U

Umbrella Stands	461
Utility Knives	113

V

Vegetable Dishes	336
Vegetable Knives	110-113
Vegetable Sieves	87
Vegetable Slicers	104
Vertical canes	138

W

Waiters Friends	432-433
Waiters Items	417-418
Waste Bins	515-517
Wastepaper Bins	514
Water Jugs	305
Wavy Slicers	145
Weck® Glass Jars	308-309, 415
Wet Floor Signs	510
Whetstones	121
Whisks	151-153, 446
Wine Coolers	424-425
Wine List Holders	479-480

Wine Sundries	421, 430-431
Wire Baskets	42
Woks	17
Wooden Boards	31, 312-313
Wooden Spaghetti Tongs	188
Work Protection	518-521

Y

Yule Log Moulds	238
-----------------------	-----

Z

Zesters	203, 447
Zucchini Cutters	139

Kochgeschirre <i>Professional Cookware</i>	Seite Page 1
GastroNorm <i>Gastronorm</i>	Seite Page 33
Aufbewahrung <i>Food & Drink Handling</i>	Seite Page 53
Speisenbearbeitung <i>Food Preparation</i>	Seite Page 99
Bäckerei & Konditorei <i>Pastry & Baking</i>	Seite Page 215
Buffet & Events <i>Buffet & Events</i>	Seite Page 287
Gedeckter Tisch <i>Tableware</i>	Seite Page 323
Serviceartikel <i>Service</i>	Seite Page 379
Getränke & Bar <i>Drinks & Barware</i>	Seite Page 423
Hotelbedarf <i>Hotel</i>	Seite Page 457
Werben & Leiten <i>Signage</i>	Seite Page 464
Ordnen & Hygiene <i>Transportation & Cleaning</i>	Seite Page 481

All Literature, price lists or other documentation provided by the Company are protected by copyright and may not be reproduced in whole or in part without the prior written authority of the Company.

All information contained in this catalogue has been carefully checked. However we reserve the right to alter specifications without notice in line with our product improvement policy.

 **contacto**® is a registered trade mark of Contacto Limited, Birmingham

© 2022 Contacto Limited. All rights reserved.
© 2022 Contacto Bander GmbH.

www.contacto.co.uk

Edition August 2022
Catalogue price: £ 10.00 excl. VAT



Sämtliche gestalteten Farbabbildungen, die besondere Gestaltung der Verkaufsunterlagen und redaktionellen Texte sind urheberrechtlich geschützt. Die Vervielfältigung dieses Kataloges auch teilweise ohne unsere ausdrückliche schriftliche Erlaubnis ist untersagt. Alle nicht urheberrechtlich geschützten Darstellungen dürfen aus wettbewerbsrechtlichen Gründen ebenfalls nur mit unserer schriftlichen Genehmigung genutzt werden.

Die Maßangaben, Abbildungen und Materialangaben in diesem Katalog sind sorgfältig zusammengestellt und auf den aktuellen Stand gebracht worden. Wir behalten uns aber Änderungen von Produktdetails ohne vorherige ausdrückliche Bekanntmachung vor. Irrtümer vorbehalten.

Volumina sind meist als Randvoll-, nicht als Nutzmaß angegeben. Durchmesser beziehen sich meist auf den Innendurchmesser.

 **contacto**® ist ein eingetragenes Warenzeichen der Contacto Bander GmbH, Erkrath.

© 2022 Contacto Bander GmbH. Alle Rechte vorbehalten.
© 2022 Contacto Limited.

www.contacto.de

Auflage August 2022
Schutzgebühr Katalog: € 10,— zzgl. USt.



1.....	316	109.....	376	199.....	190	303.....	476	419.....	59	581.....	447	693.....	245	851.....	146
3.....	316	110.....	381	202.....	383	304.....	414	422.....	12	583.....	105	694.....	244	853.....	235
4.....	316	112.....	133	204.....	383	305.....	280	425.....	411	585.....	126	695.....	278	854.....	235
5.....	208	113.....	375	206.....	101	306.....	280	428.....	411	590.....	87	696.....	278	855.....	131
6.....	317	114.....	375	209.....	187	307.....	280	429.....	411	600.....	339	697.....	246	861.....	238
7.....	317	115.....	372	211.....	187	310.....	65	432.....	14	601.....	339	698.....	246	865.....	397
8.....	317	116.....	372	212.....	64	312.....	432	444.....	360	603.....	339	699.....	244	866.....	397
9.....	317	117.....	375	215.....	512	313.....	477	446.....	411	605.....	339	700.....	360	871.....	242
10.....	317	118.....	375	217.....	184	314.....	433	450.....	210	606.....	243	703.....	375	872.....	242
14.....	136	119.....	365	218.....	189	315.....	433	451.....	264	609.....	339	705.....	375	873.....	286
15.....	136	121.....	362	219.....	192	316.....	414	453.....	433	612.....	266	708.....	375	874.....	286
17.....	136	122.....	362	220.....	389	318.....	433	454.....	433	613.....	266	710.....	260	875.....	242
19.....	136	123.....	362	221.....	189	319.....	432	455.....	132	614.....	266	711.....	260	876.....	286
24.....	431	124.....	82	222.....	389	320.....	206	458.....	273	615.....	265	712.....	238	877.....	242
25.....	159	125.....	365	225.....	432	321.....	207	459.....	273	616.....	265	715.....	166	878.....	242
27.....	277	126.....	362	227.....	190	322.....	104	460.....	273	617.....	265	721.....	225	882.....	239
28.....	279	127.....	364	228.....	269	325.....	106	485.....	128	618.....	265	727.....	243	883.....	239
30.....	213	128.....	364	229.....	185	326.....	435	488.....	212	619.....	265	730.....	168	885.....	239
31.....	213	129.....	362	230.....	269	327.....	106	490.....	212	620.....	265	731.....	168	887.....	239
32.....	213	134.....	364	232.....	397	328.....	370	491.....	164	622.....	516	735.....	238	888.....	359
34.....	407	138.....	388	234.....	63	330.....	374	498.....	270	624.....	515	736.....	238	889.....	359
35.....	159	141.....	16	236.....	191	333.....	373	499.....	271	625.....	516	738.....	226	900.....	153
37.....	142	143.....	175	237.....	73	334.....	374	500.....	77	626.....	515	740.....	119	901.....	165
38.....	213	147.....	174	238.....	193	335.....	374	502.....	383	627.....	516	741.....	119	902.....	163
39.....	211	149.....	133	241.....	94	337.....	370	503.....	376	629.....	515	742.....	119	904.....	177
45.....	148	150.....	133	242.....	94	339.....	206	504.....	383	630.....	275	743.....	119	905.....	278
50.....	88	151.....	133	244.....	103	341.....	455	505.....	376	631.....	266	744.....	119	906.....	170
51.....	319	153.....	133	246.....	132	342.....	455	506.....	383	632.....	266	745.....	128	907.....	153
52.....	395	154.....	137	247.....	285	344.....	455	507.....	76	634.....	267	750.....	247	908.....	202
53.....	310	155.....	173	258.....	494	345.....	455	509.....	78	635.....	267	760.....	269	909.....	177
54.....	137	156.....	137	259.....	429	346.....	206	510.....	248	636.....	266	765.....	247	910.....	198
55.....	131	158.....	137	260.....	426	347.....	455	511.....	183	637.....	267	770.....	334	911.....	151
56.....	495	159.....	137	261.....	424	349.....	455	513.....	192	638.....	267	773.....	275	913.....	152
58.....	310	160.....	174	262.....	428	350.....	435	514.....	189	639.....	245	775.....	274	917.....	152
59.....	310	161.....	285	263.....	425	352.....	435	516.....	248	640.....	303	777.....	274	918.....	150
60.....	285	162.....	174	264.....	426	353.....	434	517.....	248	641.....	267	778.....	274	919.....	253
63.....	445	163.....	175	265.....	453	354.....	434	518.....	247	642.....	267	787.....	275	920.....	154
64.....	396	164.....	444	266.....	425	356.....	207	519.....	248	643.....	276	788.....	274	921.....	144
65.....	396	165.....	175	267.....	453	357.....	207	520.....	93	644.....	276	797.....	305	922.....	142
66.....	395	167.....	174	268.....	426	358.....	435	522.....	263	645.....	322	800.....	334	923.....	142
68.....	285	168.....	176	269.....	429	359.....	435	523.....	17	646.....	322	801.....	334	925.....	434
69.....	285	169.....	171	270.....	148	360.....	435	524.....	17	647.....	322	802.....	334	926.....	158
70.....	157	170.....	441	271.....	148	361.....	435	526.....	17	648.....	322	804.....	334	928.....	203
72.....	157	171.....	373	272.....	148	362.....	434	527.....	263	649.....	322	806.....	448	929.....	207
73.....	157	172.....	192	273.....	148	364.....	452	528.....	17	650.....	276	807.....	146	930.....	206
74.....	157	173.....	183	274.....	50	365.....	451	530.....	17	652.....	276	808.....	448	931.....	143
75.....	157	174.....	193	275.....	210	366.....	188	535.....	512	656.....	303	811.....	264	932.....	201
78.....	160	175.....	187	276.....	210	367.....	451	536.....	512	657.....	321	817.....	146	933.....	202
80.....	154	176.....	193	277.....	210	369.....	451	537.....	512	663.....	256	820.....	151	934.....	220
81.....	154	177.....	189	278.....	210	370.....	456	538.....	511	666.....	363	821.....	151	935.....	220
82.....	154	178.....	188	279.....	210	371.....	434	543.....	368	669.....	251	822.....	249	936.....	177
83.....	155	179.....	444	280.....	162	372.....	432	544.....	368	670.....	259	823.....	249	937.....	278
84.....	155	180.....	191	281.....	161	373.....	434	545.....	79	672.....	276	824.....	84	939.....	220
86.....	160	181.....	185	282.....	493	375.....	433	547.....	512	673.....	320	825.....	85	940.....	153
87.....	158	182.....	444	283.....	494	376.....	431	548.....	11	674.....	303	826.....	151	942.....	257
88.....	100	183.....	373	284.....	494	377.....	432	549.....	92	676.....	244	827.....	152	943.....	165
89.....	100	184.....	190	285.....	493	378.....	431	551.....	92	677.....	259	828.....	446	944.....	182
90.....	100	185.....	185	286.....	493	379.....	431	555.....	87	679.....	276	830.....	152	945.....	163
92.....	160	186.....	189	287.....	425	390.....	445	557.....	87	680.....	238	831.....	181	946.....	285
93.....	160	187.....	193	288.....	426	391.....	427	559.....	87	681.....	246	832.....	253	947.....	101
94.....	103	188.....	161	289.....	424	396.....	427	560.....	149	682.....	261	833.....	253	948.....	101
95.....	160	189.....	192	290.....	320	398.....	445	561.....	149	683.....	269	834.....	152	949.....	153
96.....	101	190.....	254	291.....	424	399.....	445	569.....	388	684.....	226	835.....	152	950.....	115
97.....	155	191.....	292	292.....	429	400.....	60	571.....	106	685.....	261	836.....	181	951.....	153
98.....	193	192.....	254	293.....	429	404.....	350	572.....	105	687.....	261	837.....	251	954.....	114
100.....	381	193.....	185	296.....	428	410.....	58	573.....	107	688.....	244	838.....	188	955.....	115
103.....	381	195.....	209	297.....	428	413.....	58	574.....	107	689.....	246	839.....	188	956.....	211
105.....	381	196.....	209	299.....	427	415.....	58	576.....	106	690.....	244	840.....	251	958.....	203
107.....	377	197.....	190	300.....	476	416.....	58	578.....	107	691.....	246	842.....	250	959.....	204
108.....	363	198.....	186	302.....	414	418.....	58	580.....	320	692.....	244	843.....	250	960.....	155

Seite
Page

961..... 142	1059..... 474	1226..... 268	1446..... 374	1707..... 259	2000..... 78	2202..... 7	2285..... 407
962..... 101	1060..... 492	1227..... 268	1447..... 373	1708..... 260	2001..... 9	2203..... 8	2288..... 414
965..... 207	1064..... 478	1228..... 268	1449..... 319	1709..... 260	2002..... 78	2204..... 6	2289..... 140
966..... 178	1066..... 476	1229..... 268	1450..... 184	1710..... 259	2003..... 11	2205..... 11	2290..... 412
968..... 163	1067..... 474	1230..... 407	1451..... 184	1711..... 260	2004..... 9	2206..... 7	2292..... 412
969..... 158	1068..... 477	1236..... 341	1453..... 184	1712..... 261	2005..... 11	2207..... 7	2293..... 413
970..... 158	1069..... 476	1250..... 83	1454..... 184	1713..... 260	2006..... 10	2208..... 7	2295..... 414
971..... 169	1070..... 477	1254..... 436	1455..... 373	1714..... 261	2007..... 10	2209..... 7	2299..... 413
972..... 169	1071..... 264	1255..... 436	1459..... 72	1715..... 258	2008..... 10	2212..... 8	2320..... 493
973..... 161	1072..... 145	1257..... 436	1460..... 71	1716..... 258	2009..... 10	2213..... 8	2352..... 431
974..... 159	1073..... 142	1259..... 436	1462..... 70	1717..... 249	2010..... 10	2215..... 209	2357..... 441
975..... 177	1075..... 130	1260..... 407	1463..... 70	1718..... 250	2012..... 63	2218..... 209	2360..... 442
976..... 254	1077..... 415	1266..... 395	1464..... 71	1719..... 249	2013..... 4	2220..... 211	2362..... 442
977..... 177	1078..... 415	1269..... 282	1465..... 72	1720..... 258	2017..... 13	2221..... 211	2364..... 442
978..... 147	1080..... 86	1270..... 387	1473..... 72	1721..... 258	2022..... 78	2222..... 211	2365..... 442
979..... 121	1084..... 147	1271..... 357	1477..... 446	1725..... 250	2050..... 77	2223..... 211	2366..... 441
980..... 150	1086..... 220	1272..... 357	1478..... 450	1726..... 250	2055..... 78	2224..... 211	2370..... 444
981..... 150	1088..... 307	1273..... 283	1502..... 312	1727..... 250	2058..... 150	2226..... 209	2377..... 427
982..... 207	1090..... 143	1277..... 387	1503..... 312	1728..... 90	2060..... 270	2227..... 209	2380..... 430
983..... 221	1091..... 149	1278..... 272	1504..... 125	1729..... 506	2061..... 11	2228..... 209	2382..... 430
984..... 172	1092..... 130	1279..... 272	1505..... 125	1730..... 220	2070..... 405	2229..... 141	2388..... 430
985..... 171	1093..... 130	1310..... 75	1506..... 124	1731..... 261	2072..... 405	2230..... 110	2400..... 61
986..... 221	1094..... 114	1311..... 75	1507..... 125	1732..... 261	2073..... 405	2231..... 140	2501..... 314
987..... 83	1095..... 149	1312..... 75	1508..... 125	1733..... 264	2074..... 405	2232..... 138	2502..... 314
991..... 101	1098..... 149	1315..... 74	1509..... 125	1734..... 263	2076..... 406	2233..... 138	2503..... 315
993..... 148	1099..... 307	1320..... 74	1510..... 123	1735..... 263	2077..... 406	2234..... 141	2504..... 314
994..... 447	1100..... 432	1323..... 74	1514..... 123	1737..... 219	2078..... 406	2235..... 140	2505..... 315
995..... 196	1110..... 81	1324..... 74	1515..... 124	1738..... 218	2079..... 406	2236..... 139	2506..... 315
996..... 277	1111..... 353	1325..... 73	1520..... 123	1740..... 216	2080..... 449	2237..... 102	2509..... 315
998..... 142	1112..... 81	1329..... 91	1523..... 123	1741..... 216	2081..... 456	2238..... 356	2510..... 220
1010..... 437	1113..... 65	1330..... 82	1524..... 124	1742..... 217	2082..... 438	2239..... 139	2511..... 496
1011..... 307	1115..... 64	1333..... 346	1525..... 76	1745..... 216	2083..... 453	2240..... 412	2512..... 492
1015..... 66	1117..... 66	1336..... 149	1528..... 76	1747..... 217	2084..... 453	2241..... 138	2513..... 490
1016..... 166	1119..... 66	1340..... 79	1551..... 77	1750..... 256	2085..... 357	2242..... 140	2514..... 493
1017..... 164	1120..... 449	1341..... 79	1565..... 450	1760..... 218	2086..... 450	2243..... 140	2515..... 67
1018..... 170	1121..... 64	1343..... 80	1566..... 90	1763..... 217	2087..... 446	2244..... 139	2516..... 498
1019..... 170	1122..... 349	1344..... 80	1590..... 124	1777..... 342	2088..... 387	2245..... 140	2517..... 491
1020..... 437	1124..... 66	1347..... 79	1600..... 460	1807..... 161	2089..... 453	2246..... 140	2518..... 491
1022..... 437	1126..... 65	1351..... 127	1601..... 460	1809..... 182	2090..... 450	2247..... 447	2519..... 492
1024..... 377	1127..... 65	1355..... 127	1603..... 460	1810..... 335	2091..... 448	2248..... 139	2521..... 490
1025..... 387	1128..... 66	1357..... 126	1605..... 459	1811..... 159	2092..... 448	2249..... 139	2522..... 490
1028..... 508	1131..... 89	1358..... 127	1606..... 459	1812..... 335	2093..... 453	2250..... 181	2523..... 496
1029..... 89	1133..... 352	1380..... 150	1608..... 460	1813..... 386	2094..... 449	2251..... 141	2524..... 496
1030..... 253	1137..... 88	1401..... 14	1609..... 461	1814..... 159	2096..... 446	2252..... 179	2526..... 497
1031..... 444	1140..... 315	1403..... 14	1610..... 461	1815..... 156	2097..... 444	2253..... 139	2527..... 497
1032..... 251	1141..... 325	1405..... 13	1611..... 514	1816..... 156	2098..... 449	2254..... 181	2529..... 491
1033..... 90	1144..... 284	1406..... 14	1612..... 514	1817..... 386	2099..... 446	2255..... 117	2533..... 499
1034..... 443	1145..... 284	1408..... 14	1613..... 514	1818..... 156	2101..... 2	2256..... 139	2534..... 499
1035..... 444	1146..... 324	1411..... 361	1614..... 511	1819..... 156	2102..... 5	2257..... 145	2535..... 499
1036..... 89	1147..... 324	1412..... 361	1616..... 130	1846..... 164	2103..... 4	2258..... 139	2538..... 491
1037..... 88	1148..... 325	1413..... 361	1618..... 515	1847..... 164	2104..... 2	2259..... 139	2551..... 61
1038..... 89	1149..... 324	1414..... 361	1619..... 515	1850..... 163	2105..... 5	2260..... 97	2552..... 61
1039..... 90	1153..... 83	1415..... 397	1620..... 514	1860..... 182	2106..... 3	2261..... 8	2555..... 67
1041..... 419	1155..... 131	1416..... 361	1621..... 511	1881..... 155	2107..... 3	2262..... 97	2556..... 495
1042..... 462	1159..... 133	1417..... 361	1622..... 511	1882..... 165	2108..... 3	2267..... 103	2557..... 499
1044..... 509	1163..... 83	1418..... 97	1623..... 511	1883..... 165	2109..... 3	2268..... 144	2559..... 489
1045..... 284	1164..... 144	1420..... 96	1625..... 511	1884..... 195	2112..... 12	2269..... 102	2603..... 86
1046..... 415	1165..... 132	1422..... 97	1630..... 514	1885..... 171	2113..... 12	2270..... 143	2604..... 86
1047..... 462	1166..... 132	1424..... 96	1634..... 461	1886..... 176	2116..... 4	2271..... 143	2620..... 92
1048..... 462	1167..... 144	1428..... 374	1649..... 458	1887..... 182	2120..... 64	2272..... 144	2625..... 92
1049..... 419	1170..... 273	1429..... 365	1650..... 458	1889..... 195	2129..... 13	2274..... 257	2626..... 77
1050..... 419	1173..... 83	1430..... 96	1652..... 458	1919..... 443	2131..... 130	2275..... 142	2635..... 77
1051..... 508	1174..... 327	1434..... 97	1653..... 459	1972..... 178	2144..... 128	2276..... 257	2660..... 83
1052..... 477	1176..... 327	1435..... 328	1655..... 459	1973..... 178	2161..... 5	2277..... 143	2670..... 95
1053..... 476	1177..... 16	1436..... 328	1658..... 459	1975..... 254	2188..... 370	2278..... 141	2703..... 309
1054..... 474	1188..... 348	1437..... 328	1666..... 277	1986..... 254	2192..... 372	2279..... 145	2704..... 415
1055..... 475	1190..... 355	1439..... 328	1701..... 252	1987..... 255	2193..... 372	2280..... 412	2705..... 371
1056..... 475	1200..... 61	1440..... 317	1702..... 252	1988..... 255	2195..... 372	2282..... 413	2706..... 308
1057..... 415	1224..... 268	1441..... 316	1704..... 259	1989..... 255	2196..... 372	2283..... 412	2707..... 308
1058..... 416	1225..... 268	1443..... 389	1705..... 259	1999..... 344	2201..... 6	2284..... 411	2708..... 305

2709.....	309	3100.....	56	3397.....	333	3690.....	116	4068.....	277	4684.....	144	5080.....	27	5503.....	20
2710.....	305	3102.....	221	3398.....	333	3692.....	118	4069.....	219	4685.....	281	5087.....	26	5504.....	22
2717.....	103	3103.....	31	3400.....	227	3694.....	105	4071.....	434	4687.....	145	5088.....	23	5505.....	21
2727.....	358	3105.....	221	3401.....	393	3698.....	118	4073.....	269	4688.....	512	5090.....	32	5507.....	21
2728.....	358	3120.....	84	3403.....	396	3699.....	118	4074.....	269	4690.....	206	5091.....	32	5508.....	20
2729.....	358	3122.....	388	3405.....	393	3719.....	279	4075.....	255	4691.....	148	5092.....	32	5509.....	21
2730.....	378	3125.....	388	3421.....	482	3722.....	279	4077.....	356	4692.....	145	5093.....	32	5510.....	22
2735.....	513	3130.....	84	3423.....	483	3725.....	257	4079.....	270	4693.....	147	5094.....	32	5511.....	45
2736.....	327	3160.....	85	3425.....	482	3726.....	178	4082.....	252	4694.....	147	5100.....	27	5515.....	22
2740.....	371	3161.....	85	3428.....	483	3732.....	118	4084.....	252	4696.....	147	5103.....	251	5525.....	46
2741.....	363	3185.....	85	3429.....	483	3737.....	143	4085.....	252	4697.....	147	5110.....	241	5527.....	46
2743.....	71	3190.....	84	3432.....	483	3770.....	395	4088.....	252	4698.....	134	5140.....	387	5541.....	46
2751.....	328	3199.....	85	3433.....	483	3773.....	392	4110.....	82	4699.....	512	5151.....	384	5551.....	262
2799.....	290	3200.....	185	3440.....	270	3775.....	394	4167.....	180	4711.....	321	5154.....	384	5555.....	355
2803.....	19	3218.....	340	3444.....	227	3787.....	117	4170.....	179	4718.....	227	5156.....	384	5558.....	262
2808.....	19	3226.....	310	3445.....	227	3800.....	208	4173.....	180	4722.....	228	5160.....	385	5573.....	21
2809.....	19	3232.....	310	3470.....	162	3801.....	208	4311.....	321	4725.....	228	5161.....	385	5575.....	21
2828.....	241	3236.....	275	3471.....	167	3811.....	49	4347.....	463	4730.....	229	5166.....	385	5577.....	355
3001.....	79	3240.....	311	3474.....	167	3835.....	316	4351.....	461	4760.....	219	5217.....	340	5578.....	20
3003.....	56	3247.....	311	3476.....	167	3845.....	208	4365.....	418	4765.....	218	5219.....	340	5579.....	21
3005.....	56	3248.....	311	3477.....	181	3857.....	326	4371.....	69	4781.....	408	5243.....	415	5600.....	218
3006.....	56	3250.....	363	3479.....	185	3859.....	418	4373.....	69	4783.....	409	5250.....	26	5601.....	158
3007.....	54	3251.....	363	3493.....	183	3863.....	313	4374.....	69	4784.....	493	5251.....	25	5604.....	176
3008.....	54	3282.....	368	3500.....	227	3864.....	313	4375.....	69	4785.....	409	5252.....	26	5605.....	176
3010.....	55	3287.....	371	3501.....	393	3865.....	313	4402.....	406	4786.....	408	5253.....	26	5606.....	166
3011.....	56	3288.....	212	3502.....	394	3866.....	313	4407.....	430	4787.....	409	5254.....	26	5608.....	166
3016.....	382	3291.....	371	3503.....	396	3867.....	313	4411.....	390	4788.....	409	5255.....	25	5609.....	290
3017.....	382	3293.....	309	3504.....	392	3868.....	311	4421.....	416	4789.....	409	5257.....	31	5610.....	162
3018.....	382	3295.....	308	3511.....	392	3869.....	312	4440.....	416	4800.....	335	5258.....	31	5611.....	321
3019.....	380	3300.....	15	3600.....	108	3870.....	326	4444.....	354	4852.....	15	5259.....	25	5621.....	78
3020.....	380	3302.....	388	3601.....	110	3871.....	326	4452.....	413	4853.....	213	5305.....	394	5625.....	187
3022.....	380	3303.....	388	3602.....	110	3872.....	326	4456.....	413	4854.....	15	5308.....	394	5627.....	193
3023.....	377	3307.....	15	3603.....	114	3874.....	326	4457.....	397	4857.....	404	5310.....	392	5630.....	192
3030.....	181	3311.....	393	3604.....	172	3880.....	134	4460.....	104	4861.....	404	5311.....	392	5631.....	189
3031.....	55	3326.....	107	3605.....	171	3881.....	134	4467.....	104	4867.....	403	5326.....	391	5632.....	190
3032.....	55	3327.....	107	3606.....	114	3882.....	134	4470.....	104	4868.....	403	5340.....	438	5633.....	183
3033.....	55	3328.....	131	3612.....	114	3883.....	134	4472.....	104	4873.....	403	5342.....	438	5635.....	183
3036.....	62	3333.....	354	3614.....	108	3884.....	134	4480.....	273	4876.....	402	5343.....	438	5636.....	190
3037.....	62	3336.....	173	3615.....	110	3891.....	313	4484.....	263	4878.....	403	5344.....	438	5656.....	187
3038.....	62	3337.....	173	3616.....	109	3893.....	312	4486.....	262	4880.....	402	5345.....	437	5659.....	191
3048.....	517	3340.....	120	3617.....	109	3898.....	327	4492.....	325	4881.....	402	5350.....	305	5660.....	186
3050.....	73	3341.....	120	3618.....	108	3910.....	416	4493.....	325	4882.....	403	5351.....	396	5661.....	176
3053.....	516	3342.....	120	3620.....	110	4001.....	502	4494.....	325	4883.....	402	5353.....	391	5662.....	173
3055.....	94	3344.....	263	3626.....	110	4002.....	502	4511.....	390	4884.....	404	5354.....	391	5664.....	192
3056.....	508	3345.....	121	3627.....	110	4003.....	502	4512.....	390	4885.....	404	5355.....	77	5665.....	186
3060.....	93	3346.....	120	3630.....	109	4006.....	502	4545.....	499	4886.....	404	5356.....	436	5666.....	186
3061.....	256	3347.....	121	3633.....	115	4007.....	500	4547.....	500	4888.....	335	5358.....	439	5667.....	189
3062.....	256	3350.....	297	3635.....	110	4009.....	500	4600.....	111	4889.....	404	5359.....	439	5668.....	191
3063.....	256	3351.....	166	3636.....	110	4010.....	502	4602.....	111	4890.....	404	5360.....	191	5669.....	135
3065.....	73	3352.....	296	3638.....	108	4012.....	63	4603.....	111	4902.....	167	5362.....	167	5670.....	410
3066.....	251	3353.....	296	3640.....	109	4020.....	247	4604.....	172	4903.....	167	5364.....	89	5671.....	410
3067.....	509	3354.....	156	3644.....	129	4021.....	248	4605.....	111	4905.....	356	5366.....	391	5674.....	218
3069.....	509	3355.....	168	3645.....	129	4022.....	247	4606.....	111	4907.....	51	5400.....	50	5675.....	219
3070.....	81	3356.....	168	3650.....	257	4023.....	247	4607.....	111	4909.....	410	5401.....	319	5677.....	188
3071.....	517	3357.....	159	3655.....	128	4024.....	248	4608.....	355	4910.....	365	5402.....	320	5678.....	188
3073.....	517	3359.....	182	3656.....	130	4030.....	329	4615.....	376	4911.....	47	5405.....	50	5683.....	219
3075.....	517	3360.....	173	3659.....	121	4031.....	329	4620.....	376	4931.....	47	5406.....	51	5685.....	186
3077.....	93	3361.....	299	3660.....	121	4053.....	278	4625.....	372	4940.....	320	5407.....	51	5686.....	186
3078.....	93	3362.....	190	3661.....	122	4054.....	245	4626.....	341	5000.....	502	5408.....	241	5688.....	162
3080.....	57	3363.....	168	3662.....	122	4056.....	178	4640.....	336	5003.....	27	5420.....	95	5690.....	175
3081.....	57	3364.....	168	3666.....	272	4057.....	257	4644.....	336	5007.....	27	5421.....	95	5692.....	177
3083.....	57	3365.....	299	3670.....	171	4058.....	179	4647.....	395	5011.....	47	5425.....	95	5698.....	162
3086.....	57	3366.....	277	3680.....	116	4060.....	180	4650.....	337	5020.....	247	5427.....	96	5699.....	175
3088.....	54	3367.....	172	3682.....	116	4061.....	219	4660.....	354	5030.....	27	5428.....	95	5700.....	218
3092.....	306	3369.....	298	3683.....	117	4062.....	179	4666.....	355	5066.....	23	5430.....	241	5731.....	329
3093.....	306	3390.....	332	3684.....	117	4063.....	257	4671.....	341	5073.....	24	5454.....	91	5733.....	329
3094.....	489	3391.....	332	3685.....	117	4064.....	179	4672.....	281	5074.....	24	5455.....	91	5751.....	29
3095.....	489	3392.....	333	3686.....	109	4065.....	180	4678.....	282	5075.....	24	5500.....	22	5756.....	29
3096.....	306	3394.....	333	3687.....	109	4066.....	180	4680.....	281	5076.....	24	5501.....	22	5757.....	30
3099.....	489	3395.....	333	3689.....	303	4067.....	255	4682.....	281	5077.....	23	5502.....	22	5758.....	30

Seite
Page

5762..... 29	5899..... 507	6370..... 226	6641..... 233	6833..... 485	7230..... 474	7679..... 470	8087..... 440
5763..... 31	6000..... 507	6371..... 226	6642..... 234	6837..... 485	7311..... 36	7680..... 465	8088..... 440
5764..... 31	6004..... 5	6372..... 225	6643..... 234	6838..... 484	7411..... 41	7682..... 465	8089..... 440
5765..... 29	6011..... 321	6373..... 225	6644..... 232	6855..... 367	7500..... 16	7683..... 465	8090..... 503
5766..... 30	6028..... 113	6374..... 226	6645..... 232	6863..... 366	7511..... 37	7684..... 465	8091..... 75
5767..... 30	6029..... 112	6375..... 248	6646..... 234	6867..... 367	7522..... 462	7685..... 471	8093..... 503
5770..... 28	6030..... 113	6376..... 243	6647..... 233	6868..... 367	7523..... 480	7687..... 466	8100..... 486
5771..... 29	6031..... 112	6377..... 228	6648..... 234	6869..... 367	7525..... 513	7688..... 466	8102..... 486
5773..... 17	6032..... 112	6378..... 225	6649..... 233	6880..... 401	7527..... 510	7689..... 470	8104..... 488
5775..... 28	6033..... 112	6379..... 225	6650..... 233	6882..... 339	7528..... 510	7690..... 467	8107..... 492
5776..... 29	6034..... 112	6390..... 235	6651..... 232	6885..... 213	7529..... 510	7691..... 466	8108..... 488
5777..... 28	6035..... 113	6392..... 235	6652..... 231	6886..... 337	7530..... 419	7692..... 464	8109..... 487
5779..... 30	6036..... 113	6411..... 36	6670..... 230	6889..... 368	7531..... 439	7695..... 464	8111..... 39
5780..... 336	6037..... 113	6435..... 399	6671..... 230	6890..... 338	7532..... 419	7696..... 464	8211..... 48
5782..... 127	6038..... 113	6440..... 398	6672..... 231	6899..... 338	7533..... 419	7701..... 473	8311..... 49
5811..... 321	6039..... 171	6441..... 398	6673..... 230	6901..... 318	7534..... 462	7702..... 473	8411..... 37
5825..... 480	6041..... 128	6442..... 398	6679..... 234	6905..... 318	7535..... 510	7703..... 473	8611..... 40
5829..... 480	6042..... 113	6443..... 399	6680..... 245	6908..... 318	7538..... 262	7711..... 38	8711..... 40
5830..... 479	6066..... 395	6446..... 398	6681..... 236	6910..... 318	7539..... 291	7744..... 51	8759..... 437
5831..... 479	6069..... 94	6448..... 399	6685..... 236	6911..... 318	7541..... 262	7755..... 50	8766..... 330
5832..... 479	6070..... 221	6449..... 399	6686..... 236	6915..... 306	7544..... 495	7760..... 228	8767..... 331
5833..... 480	6071..... 42	6450..... 401	6687..... 237	6931..... 253	7548..... 449	7777..... 169	8768..... 331
5834..... 418	6077..... 81	6480..... 400	6688..... 237	6933..... 253	7550..... 509	7780..... 164	8769..... 331
5835..... 503	6079..... 82	6481..... 400	6689..... 237	6941..... 16	7551..... 456	7781..... 172	8770..... 331
5836..... 417	6080..... 82	6487..... 127	6690..... 237	6947..... 16	7554..... 102	7782..... 114	8771..... 331
5837..... 418	6081..... 81	6490..... 400	6691..... 237	6948..... 16	7555..... 68	7783..... 279	8772..... 330
5838..... 417	6083..... 161	6497..... 399	6696..... 235	7002..... 494	7556..... 44	7784..... 355	8773..... 18
5839..... 456	6086..... 82	6498..... 399	6711..... 39	7003..... 494	7557..... 68	7785..... 155	8774..... 19
5840..... 74	6088..... 81	6511..... 41	6729..... 39	7004..... 487	7558..... 68	7786..... 169	8775..... 18
5843..... 72	6101..... 13	6526..... 518	6740..... 272	7006..... 488	7560..... 439	7787..... 169	8776..... 18
5844..... 452	6103..... 23	6527..... 518	6741..... 272	7007..... 43	7561..... 44	7788..... 164	8777..... 19
5845..... 451	6111..... 40	6530..... 521	6742..... 272	7008..... 43	7562..... 245	7790..... 159	8778..... 19
5847..... 451	6161..... 13	6531..... 520	6751..... 271	7009..... 43	7566..... 495	7791..... 182	8880..... 401
5848..... 91	6184..... 336	6532..... 520	6752..... 443	7010..... 36	7568..... 495	7792..... 279	8889..... 368
5849..... 452	6188..... 337	6533..... 520	6753..... 443	7011..... 35	7569..... 430	7793..... 277	8894..... 377
5852..... 451	6200..... 336	6534..... 521	6754..... 146	7020..... 286	7571..... 44	7795..... 176	8895..... 377
5853..... 452	6201..... 304	6536..... 520	6760..... 425	7029..... 42	7572..... 69	7811..... 38	8941..... 156
5854..... 452	6202..... 485	6537..... 103	6767..... 425	7030..... 304	7580..... 500	7850..... 422	8942..... 294
5855..... 89	6207..... 305	6539..... 519	6768..... 471	7036..... 309	7611..... 37	7853..... 422	8943..... 165
5858..... 214	6208..... 483	6540..... 519	6769..... 475	7040..... 386	7615..... 86	7855..... 422	8944..... 293
5859..... 452	6222..... 341	6541..... 519	6770..... 471	7047..... 290	7624..... 212	7860..... 422	8945..... 179
5860..... 335	6224..... 341	6543..... 521	6771..... 477	7049..... 291	7626..... 212	7868..... 420	8946..... 294
5862..... 335	6226..... 341	6544..... 521	6772..... 478	7050..... 73	7629..... 42	7870..... 421	8947..... 294
5864..... 506	6301..... 223	6550..... 519	6775..... 418	7052..... 43	7630..... 42	7871..... 421	8948..... 162
5865..... 258	6302..... 223	6551..... 417	6776..... 410	7053..... 290	7632..... 472	7874..... 420	8949..... 295
5866..... 504	6303..... 223	6552..... 417	6778..... 410	7055..... 289	7633..... 472	7875..... 421	8951..... 183
5867..... 448	6304..... 223	6553..... 417	6779..... 479	7067..... 50	7634..... 470	7876..... 420	8952..... 295
5868..... 456	6305..... 223	6556..... 519	6780..... 478	7073..... 291	7635..... 471	7877..... 421	8953..... 278
5871..... 507	6306..... 224	6560..... 505	6781..... 478	7074..... 289	7636..... 472	7879..... 420	8954..... 294
5872..... 129	6307..... 224	6561..... 505	6783..... 475	7076..... 289	7642..... 472	7910..... 37	
5873..... 507	6308..... 223	6563..... 505	6784..... 475	7081..... 290	7647..... 467	7911..... 42	
5874..... 507	6309..... 224	6580..... 84	6785..... 445	7085..... 288	7649..... 291	7981..... 122	
5875..... 507	6310..... 241	6602..... 7	6786..... 442	7087..... 289	7653..... 463	7987..... 122	
5876..... 506	6311..... 229	6610..... 340	6787..... 427	7089..... 289	7654..... 463	7988..... 122	
5877..... 507	6312..... 224	6611..... 292	6788..... 366	7093..... 288	7655..... 463	8000..... 369	
5878..... 513	6313..... 222	6616..... 340	6789..... 426	7096..... 288	7658..... 469	8002..... 49	
5879..... 513	6314..... 222	6622..... 329	6791..... 478	7098..... 292	7659..... 468	8003..... 357	
5880..... 509	6315..... 217	6623..... 329	6793..... 103	7099..... 292	7661..... 468	8005..... 356	
5881..... 506	6316..... 226	6627..... 340	6794..... 366	7110..... 41	7662..... 463	8008..... 369	
5882..... 506	6318..... 222	6630..... 234	6795..... 366	7115..... 41	7663..... 468	8020..... 369	
5883..... 506	6320..... 222	6631..... 231	6796..... 366	7132..... 286	7664..... 468	8025..... 369	
5885..... 505	6323..... 229	6632..... 231	6800..... 337	7170..... 513	7666..... 471	8028..... 369	
5886..... 505	6324..... 229	6633..... 232	6801..... 337	7172..... 513	7668..... 467	8030..... 369	
5887..... 505	6335..... 187	6634..... 231	6802..... 337	7191..... 503	7670..... 469	8033..... 67	
5888..... 504	6360..... 240	6635..... 232	6803..... 338	7198..... 473	7672..... 510	8034..... 67	
5890..... 504	6361..... 240	6636..... 232	6806..... 338	7199..... 473	7673..... 469	8035..... 68	
5891..... 504	6362..... 240	6637..... 233	6808..... 338	7211..... 38	7674..... 469	8055..... 365	
5893..... 440	6363..... 240	6638..... 233	6818..... 485	7225..... 386	7675..... 469	8070..... 500	
5895..... 440	6366..... 224	6639..... 233	6830..... 484	7226..... 386	7676..... 407	8083..... 439	
5897..... 504	6368..... 240	6640..... 231	6832..... 485	7229..... 384	7678..... 470	8084..... 440	



--	--	--	--	--	--	--	--