



# Product catalogue

Performance meets sustainability

# Performance meets sustainability.

A new chapter in professional cleaning.

Welcome to the Vileda Professional product catalogue. Full of first-class cleaning solutions that support sustainable values and are driven by innovation and responsibility. Vileda Professional products are crafted to perfection and many feature our "Love it Clean" logo, which symbolizes our commitment to sustainability for you, your customers and the planet. A clear goal drives us at Vileda Professional: To transform our customer-centric approach into cleaning solutions that give you a competitive edge and allow you to also make a commitment to sustainability.

## **Clean meets Green.**

As a global leader in cleaning solutions, we firmly believe that every product we develop must contribute to a sustainable future. That is why we created a new series of products that save resources without reducing performance or durability – made of up to 100% recycled materials. Take advantage of and rely on best-in-class cleaning performance, bacteria/virus removal, intuitive handling and ergonomics and further grow your business by contributing to a healthier planet.

## **Since we love it clean, everywhere.**

We use our "Love It Clean" label to highlight the most sustainable product choices. This label helps you recognize our goal to reduce waste and our commitment to increase recycling and safety, while delivering excellent product performance. In recent years we have steadily increased the use of recycled plastics in manufacturing, but we acknowledge our responsibility to continue to improve and take action where we can make a difference. That is why we have founded our internal and external sustainability initiative "Love It Clean".

## **Clear milestones mark our way to a sustainable future.**

We are proud to announce that we are a signatory of the Ellen MacArthur Foundation's New Plastics Economy Global Commitment. As such, we are working to eliminate non-recyclable packaging and to achieve 100% recyclable, reusable, or compostable alternatives. Furthermore, we are continuously increasing the amount of recycled material in our solid plastic products themselves.

## **Customer comes first, and second, and third**

Customer understanding is paramount: the better we understand your business, the better our products meet your complex needs. Your success is our success. That is why we have transformed our "Listen and Learn" approach to a customer-centric strategy. This customer focus is how we guarantee you get the best solutions and services to contribute to your competitive advantage. Be it in offices, hospitals, hotels or controlled environments, Vileda Professional stands ready as your partner.

**Explore all our innovations and lead your business to sustainable success. Welcome to Vileda Professional!**



Wiping

Scouring

Gloves

Floor Cleaning

Brushware

Trolleys

Waste Management

## Symbols & icons

### Sustainability



Highlights our most sustainable product choices



Products awarded by the Nordic Swan Ecolabel



Products awarded by the Plastica Seconda Vita

### Product features



Indicates product features and benefits

### Application areas



Health Care



HoReCa



General Building



Cleanroom Environment

# Index

<b>Wiping</b>	<b>5</b>	<b>Brushware</b>	<b>61</b>
A wipe for every need	6	Dustpans	66
Microfibre Cloths	10		
Coated Microfibre Cloths	14	<b>Trolleys</b>	<b>67</b>
Single Use Microfibre Cloths	14	Comodino Hotel Trolley	68
PVA Cloths	15	Equipe Hotel	69
Sponge Cloths	15	Origo 2	72
All-purpose and Semi-disposable Cloths	16	Origo Flexible	74
Above the Floor Cleaning Tools	17	Origo Line	82
Window Cleaning	18	VoleoPro	89
		Shopster	90
<b>Scouring</b>	<b>19</b>		
Scourer	20	<b>Waste Management</b>	<b>91</b>
Handpads	21		
PurActive	21	<b>Products (Overview)</b>	<b>94</b>
Inox Scourers	22		
Miraclean	22		
<b>Gloves</b>	<b>23</b>		
Nitrile Gloves	25		
Latex Gloves	26		
<b>Floor Cleaning</b>	<b>29</b>		
WetDryCleaning	30		
The New Swep Class	34		
Swep System	35		
Twixter	39		
UltraSpeed Pro	42		
CombiSpeed Pro System	44		
Vertical Mopping Systems	47		
SprayPro Inox	49		
Express Pro (Hook and Loop) Flat Mops	50		
ClickSpeed Pre-Prepared System	51		
Handles	52		
Floor Cloth	53		
Disposable Dustmopping	54		
Durable Dustmopping	55		
Floorpads	56		
Floorpads for Special Tasks	58		
Edging Tools & Pads	59		
Special Handpads	60		



Wiping

Scouring

Gloves

Floor Cleaning

Brushware

Trolleys

Waste Management

# Wiping

Which properties do you need? High absorbency for wet surfaces? Absolutely streak-free, lint-free cleaning for glossy surfaces? Removal of grease and stubborn fingerprints in a single wipe – without chemicals?







Which method suits your cleaning and hygiene tasks best? Bucket method? Spray-cleaning system or pre-preparation of cloths? Vileda Professional's comprehensive range includes cloths for every need and every system, from economical semi-disposables to advanced microfibres.











## A wipe for every need Healthcare

Vileda Professional offers the highest grade of cleanliness and maximum contamination control for highly sensitive hygienic areas. From patient rooms, operating theatres and examination rooms in hospitals – Vileda Professional can provide you with what it takes to raise the overall hygiene levels and minimize infection rates significantly at the lowest possible total costs.

### Key challenges / needs:

-  Hygienic cleaning for the benefit of patients, visitors and employees
-  Reliable, certified removal of microorganisms
-  Prevention of cross-contamination through pre-preparation method and/or single-use wipes
-  Homogeneous apply of disinfectant on a large surface
-  High resistance against daily washing
-  High stability against a wide range of disinfectants

## A wipe for every need Which is yours?

	Good performance*	Better performance	Best performance
Machine washable wipes	Pre-prepared method  MicroSorb	 r-MicronQuick	 r-NanoTech micron
	Bucket method  MicroTuff Base	 r-MicroTuff Swift	 r-MicroTuff Plus
Single-use wipes	Pre-prepared method  MicroOne		
	Bucket method  GP Plus		 MicroRoll

\*Only better and best performing wipes are recommended for Hygienic Sensitive Areas.



Wiping

Scouring

A wipe for every need

# General Cleaning Areas

Airports, public transports, malls, conference rooms, entrance areas. Numerous public spaces with large and shiny surfaces have to be cleaned quickly and effectively every day. To meet all those demands, you can always count on Vileda Professional's most efficient and high performing wipes.

Key challenges / needs:



Streak-free cleaning



Efficient particle pick-up



Suitable for a wide range of surfaces



Long product life cycle



High coverage performance in between rinsing cycles



Easy removal of fatty dirt, e.g. fingerprints

A wipe for every need

## Which is yours?

	Good performance	Better performance	Best performance
Long term wipes	Extra absorbency MicroTuff Base / WiPro	r-MicroTuff Swift / MicroTuff Universal	r-MicroTuff Plus / PVAmicro
	Streak-free cleaning PVA Perfo	PVAmicro / Softy	r-MicronQuick
Short term wipes	GP Plus	Breazy	MicroTuff Easy

Gloves

Floor Cleaning

Brushware

Trolleys

Waste Management











## A wipe for every need Food & Beverage

Keeping a high level of hygiene and food safety is paramount in areas that process food like restaurants, kitchens and bars. You can rely on Vileda Professional's comprehensive assortment of highly efficient and effective cleaning solutions for your every need.

### Key challenges / needs:

-  Streak-free cleaning
-  Fast removal of spills
-  Prevention of cross-contamination by colour coding
-  Efficient removal of stubborn fatty dirt
-  Drying and polishing at the same time
-  Cost efficiency due to excellent wear & tear-resistance

## A wipe for every need Which is yours?

	Good performance	Better performance	Best performance
General cleaning wipes	Long term  MicroTuff Base / WiPro	 r-MicroTuff Swift / MicroTuff Universal	 PVAmicro / r-MicronQuick
	Short term  GP Plus	 Breazy	 MicroTuff Easy
Dish drying & polishing towels		 r-MicronGlass	 Microfibre TeaTowel
Water handling wipes		 Quick 'n Dry	 Sponge Cloth "aqua"
Heat resistant wipes		 Breazy	 Sponge Cloth "aqua"





Wiping

Scouring

## A wipe for every need

# Hotels

Guests not only expect optically clean hotel rooms but hygienically clean rooms and hotel facilities. Vileda Professional offers innovative cleaning products to significantly improve the cleanliness and hygiene of all accommodations. The result is an optimized cost-quality ratio, ensure hygiene requirements and value preservation by the appropriate and correct use of cleaning products.

### Key challenges / needs:



Streak-free cleaning



Efficient particle pick-up



Suitable for a wide range of surfaces



Long product life cycle



High coverage performance in between rinsing cycles



Easy removal of fatty dirt, e.g. fingerprints

## A wipe for every need

### Which is yours?

		Good performance	Better performance	Best performance
General cleaning wipes	Long term	MicroTuff Base / WiPro	r-MicroTuff Swift / MicroTuff Universal	PVA micro / r-MicronQuick
	Short term	GP Plus	Breazy	MicroTuff Easy
Wipes for streak-free cleaning	Long term	PVA Perfo	PVA micro / Softy	r-MicronQuick

Gloves

Floor Cleaning

Brushware

Trolleys

Waste Management

# Microfibre Cloths

## r-NanoTech micron



The new recycled durable microfibre cloth with silver particles.

- ✓ Superior cleaning performance due to advanced microfibre technology
- ✓ \*Can be stored in damp conditions after washing for up to 72 hours
- ✓ \*Up to 99.99% bovine coronavirus removal from vinyl surfaces as tested at a 3rd party lab
- ✓ Up to 99.99% bacteria removal (P. aeruginosa & S. aureus on vinyl surfaces at a 3rd party lab)
- ✓ Made of 67% recycled fibres
- ✓ No need for tumble drying
- ✓ Ideal for the pre-prepared cleaning method

Art.no. Case TSU	Description	Size in cm	Pieces/pack	Packs/case	Art.no. Pack BCU	Application
171670	r-NanoTech micron, blue	40 x 38	5	20	171671	
171672	r-NanoTech micron, red	40 x 38	5	20	171673	
171674	r-NanoTech micron, green	40 x 38	5	20	171675	
171676	r-NanoTech micron, yellow	40 x 38	5	20	171677	

## r-MicronQuick



The new recycled durable microfibre cloth.

- ✓ Superior cleaning performance
- ✓ Streak-free and lint free cleaning
- ✓ \*Up to 99.99% bovine coronavirus removal from vinyl surfaces as tested at a 3rd party lab
- ✓ Up to 99.99% bacteria removal (P. aeruginosa & S. aureus on vinyl surfaces at a 3rd party lab)
- ✓ Made of 70% recycled fibres
- ✓ Improved wear resistance
- ✓ Ideal for the pre-prepared cleaning method

Art.no. Case TSU	Description	Size in cm	Pieces/pack	Packs/case	Art.no. Pack BCU	Application
170605	r-MicronQuick, blue	40 x 38	5	20	170635	
170632	r-MicronQuick, red	40 x 38	5	20	170636	
170634	r-MicronQuick, green	40 x 38	5	20	170638	
170633	r-MicronQuick, yellow	40 x 38	5	20	170637	

## MicronClean Plus



MicronClean Plus provides excellent cleaning and polishing performance especially on shiny surfaces.

- ✓ Made from finest microfibres for superior cleaning performance
- ✓ Very efficient removal even of fatty dirt
- ✓ Ideal for streak-free cleaning
- ✓ Endless fibres for lint-free cleaning results
- ✓ Very quick and easy to rinse, no particles or hair stay in the wipe

Art.no. Case TSU	Description	Size in cm	Pieces/pack	Packs/case	Art.no. Pack BCU	Application
152530	MicronClean Plus, blue	40 x 45	5	20	152535	
152531	MicronClean Plus, red	40 x 45	5	20	152537	
152532	MicronClean Plus, yellow	40 x 45	5	20	152538	
152533	MicronClean Plus, green	40 x 45	5	20	152539	
152534	MicronClean Plus, grey	40 x 45	5	20	152540	

## MicroSorb and MicroSorb Light



- Quick and easy microfibre cleaning
- Non-woven structure
- Easy to rinse and clean
- MicroSorb: 170 g/m<sup>2</sup>
- MicroSorb Light: 130 g/m<sup>2</sup>

Art.no. Case TSU	Description	Size in cm	Pieces/pack	Packs/case	Art.no. Pack BCU	Application
126856	MicroSorb, blue	40 x 40	5	10	126858	
126855	MicroSorb, red	40 x 40	5	10	126857	
133482	MicroSorb, green	40 x 40	5	10	133488	
133481	MicroSorb, yellow	40 x 40	5	10	133487	
133483	MicroSorb Light, blue	40 x 40	5	10	133489	
133484	MicroSorb Light, red	40 x 40	5	10	133490	
133485	MicroSorb Light, green	40 x 40	5	10	133491	
133486	MicroSorb Light, yellow	40 x 40	5	10	133492	

## MicroTuff Universal



- Robust, voluminous, knitted microfibre cloth
- With abrasive stripes for easier removal of adhering dirt
- Excellent bulky feel and volume in your hand
- Grammage: 270 g/m<sup>2</sup>



Art.no. Case TSU	Description	Size in cm	Pieces/pack	Packs/case	Art.no. Pack BCU	Application
158502	MicroTuff Universal, blue	40 x 40	10	10	158503	
158504	MicroTuff Universal, red	40 x 40	10	10	158505	
158508	MicroTuff Universal, green	40 x 40	10	10	158509	
158506	MicroTuff Universal, yellow	40 x 40	10	10	158507	

## r-MicroTuff Plus



The extra durable recycled premium knitted cleaning cloth for superior cleanliness and highest cleaning coverage

- Highest microfibre cleaning power due to extra-fine microfibers
- Superior durability up to 700 washes for an even higher sustainable impact
- Made from 89% recycled polyester fibers in the cloth produced from post-consumer plastic waste
- \*Up to 99.99% removal of bacteria and viruses from vinyl surfaces tested at a 3rd party lab
- Highest absorbency for excellent spill removal and strong particle pick-up
- Excellent removal of fatty and stubborn dirt without using chemicals
- Available in four colours for hygienic colour coding



Art.no. Case TSU	Description	Size in cm	Pieces/pack	Packs/case	Art.no. Pack BCU	Application
174191	r-MicroTuff Plus, blue	38 x 38	5	20	174192	
174200	r-MicroTuff Plus, red	38 x 38	5	20	174201	
174204	r-MicroTuff Plus, yellow	38 x 38	5	20	174205	
174202	r-MicroTuff Plus, green	38 x 38	5	20	174203	

## r-MicroTuff Swift



Cleaning cloth made from 100% recycled materials.  
100% Microfibre cleaning power.

- ✓ 100% Microfibre cleaning power
- ✓ \*Up to 99.99% bovine coronavirus removal from vinyl surfaces as tested at a 3rd party lab
- ✓ Nordic Swan Ecolabel awarded
- ✓ 2 PET Bottles are re-used in 1 cloth
- ✓ Very high particle pick-up
- ✓ Absorbent, excellent for spillage

Art.no. Case TSU	Description	Size in cm	Pieces/pack	Packs/case	Art.no. Pack BCU	Application
168755	r-MicroTuff Swift, blue	35 x 38	5	20	168756	
168761	r-MicroTuff Swift, red	35 x 38	5	20	168762	
168759	r-MicroTuff Swift, yellow	35 x 38	5	20	168760	
168757	r-MicroTuff Swift, green	35 x 38	5	20	168758	

## MicroTuff Base



Knitted multi-purpose cleaning cloth. Microfibre cleaning power for general application and everyday use.

- ✓ Microfibre cleaning power made from 100% Polyester
- ✓ Nordic Swan Ecolabel awarded
- ✓ High particle pick-up
- ✓ Good absorbency and spill pick-up

Art.no. Case TSU	Description	Size in cm	Pieces/pack	Packs/case	Art.no. Pack BCU	Application
169906	MicroTuff Base, blue	36 x 36	5	20	169907	
169914	MicroTuff Base, red	36 x 36	5	20	169915	
169912	MicroTuff Base, yellow	36 x 36	5	20	169913	
169910	MicroTuff Base, green	36 x 36	5	20	169911	

## Softy



Soft Touch. Strong Clean. Its flatknitted microfibre power gives perfect grip and maximum cleaning control. Use it for dry, wet or damp cleaning and always get a streak-free result.

- ✓ Ideal for slightly damp cleaning tasks
- ✓ Good cleaning performance and gliding properties
- ✓ Powerful cleaning thanks to microfibre mix
- ✓ Streak-free cleaning without separate drying on any smooth surface such as acrylic, plexiglass, painted or polished floors and even glass and mirrors

Art.no. Case TSU	Description	Size in cm	Pieces/pack	Packs/case	Art.no. Pack BCU	Application
175030	Softy, blue	40 x 40	5	20	175030	
175040	Softy, red	40 x 40	5	20	175040	
175041	Softy, green	40 x 40	5	20	175041	
175042	Softy, yellow	40 x 40	5	20	175042	
175043	Softy, grey	40 x 40	5	20	175043	

## Microfibre TeaTowel

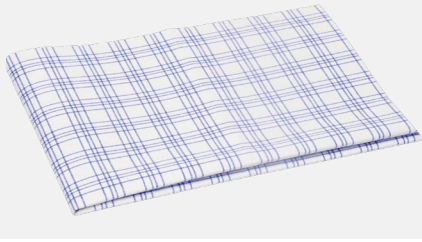

Microfibre TeaTowel is characterised by its high drying and polishing performance on glass, dishes and cutlery for greater time-efficiency.

- ✓ Excellent drying results without any streaks
- ✓ Extra high absorbency for increased efficiency
- ✓ No linting due to endless fibres
- ✓ One-step drying and polishing
- ✓ Quick-drying material for faster re-use compared to traditional tea towels



Art.no. Case TSU	Description	Size in cm	Pieces/pack	Packs/case	Art.no. Pack BCU	Application
128424	Microfibre TeaTowel	40 x 60	3	30	128425	

Wiping

Scouring

## MicroWindow



MicroWindow consists of extra-fine microfibres for the effective cleaning of large, shiny surfaces with streak-free results.

- ✓ Very efficient removal of any fatty dirt even on shiny surfaces
- ✓ Endless fibres for lint-free cleaning results
- ✓ Very quick and easy to rinse, no particles or hair stay in the wipe
- ✓ Ideal for window cleaning



Art.no. Case TSU	Description	Size in cm	Pieces/pack	Packs/case	Art.no. Pack BCU	Application
152701	MicroWindow, yellow	35 x 39	10	10	152702	

Gloves

Floor Cleaning

## r-MicronGlass



The new recycled durable microfibre cloth.

- ✓ Superior cleaning performance due to advanced microfibre technology
- ✓ High absorbency
- ✓ Streak-free and lint free cleaning
- ✓ \*Up to 99.99% bovine coronavirus removal from vinyl surfaces as tested at a 3rd party lab
- ✓ Up to 99.99% bacteria removal (P. aeruginosa & S. aureus on vinyl surfaces at a 3rd party lab)
- ✓ Made of 70% recycled fibres



Art.no. Case TSU	Description	Size in cm	Pieces/pack	Packs/case	Art.no. Pack BCU	Application
170700	r-MicronGlass, blue	40 x 50	5	20	170701	

Brushware

Trolleys

Waste Management

# Coated Microfibre Cloths



## PVAmicro



Our most successful microfibre wipe PVAmicro achieves streak-free cleaning results with only one-step through a unique coating technology.

- ✓ Made from extra-fine microfibres for very high cleaning performance
- ✓ \*Up to 99.99% bovine coronavirus removal from vinyl surfaces as tested at a 3rd party lab
- ✓ Advanced efficiency in the removal of fatty dirt for brilliant results
- ✓ Maximum absorbency for time-efficient cleaning of large areas
- ✓ Very quick and easy to rinse, no particles or hair stay in the wipe
- ✓ High coverage performance due to homogenous water release

Art.no. Case TSU	Description	Size in cm	Pieces/pack	Packs/case	Art.no. Pack BCU	Application
143585	PVAmicro, blue	35 x 38	5	20	143590	
143586	PVAmicro, red	35 x 38	5	20	143591	
143587	PVAmicro, yellow	35 x 38	5	20	143592	
143588	PVAmicro, green	35 x 38	5	20	143593	

## PURmicro Active



- ✓ Streak-free and lint-free cleaning of shiny surfaces
- ✓ With extra-fine microfibres for very high cleaning performance
- ✓ The additional PUR (polyurethane) coating increases the rinsability and makes this new cloth a perfect allrounder
- ✓ High liquid absorbency and high dirt release when rinsing
- ✓ Ideal for bucket method
- ✓ The 5 color system offers simple differentiation of cloths and individual adaptation to hygiene system

Art.no. Case TSU	Description	Size in cm	Pieces/pack	Packs/case	Art.no. Pack BCU	Application
174045	PURmicro Active, blue	38 x 35	5	20	174046	
174047	PURmicro Active, red	38 x 35	5	20	174048	
174071	PURmicro Active, yellow	38 x 35	5	20	174072	
174049	PURmicro Active, green	38 x 35	5	20	174070	

# Single Use Microfibre Wipe



## MicroOne



The single-use MicroOne wipes are designed for safe and easy pre-preparation and hygienic handling.

- ✓ Made from extra-fine microfibres for very high cleaning performance
- ✓ Efficient removal even of fatty dirt
- ✓ \*Up to 99.99% bacteria removal (P. aeruginosa & S. aureus on vinyl surfaces at a 3rd party lab)

Art.no. Case TSU	Description	Size in cm	Pieces/pack	Packs/case	Art.no. Pack BCU	Application
148759	MicroOne, red	27 x 34	50	10	148763	
148758	MicroOne, blue	27 x 34	50	10	148762	

## MicroRoll



The single-use MicroRoll wipe provides lint-free cleaning results through our endless microfibre technology.

- ✓ Made from extra-fine microfibres for very high cleaning performance
- ✓ Efficient removal even of fatty dirt
- ✓ \*Up to 99.99% bovine coronavirus removal from vinyl surfaces as tested at a 3rd party lab
- ✓ Up to 99.99% bacteria removal (P. aeruginosa & S. aureus on vinyl surfaces at a 3rd party lab)

Art.no. Case TSU	Description	Size in cm	Pieces/pack	Packs/case	Art.no. Pack BCU	Application
149041	MicroRoll, white	25 x 35	1 roll (200 wipes)	4	149042	

## PVA Cloths

### PVA Perfo

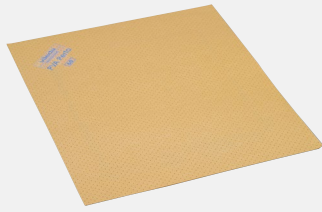

Our PVA Perfo wipe is made from a unique material providing efficient absorbency and streak-free cleaning results.

- ✓ Suitable for streak-free cleaning
- ✓ Good particle pick-up due to perforation structure
- ✓ Easy to rinse out particles or hair
- ✓ Long product life cycle

Art.no. Case TSU	Description	Size in cm	Pieces/pack	Packs/case	Art.no. Pack BCU	Application
100183	PVA Perfo	35 x 40	10	10	100774	

## Sponge Cloths

### Sponge cloth "aqua"



The sponge cloth aqua cleans surfaces effortlessly without streaks and is extremely absorbent.

- ✓ Made from natural materials – 100% biodegradable
- ✓ High absorbency for efficient spill removal
- ✓ Absorbs up to 10 times its own weight
- ✓ Pleasantly soft and bulky feel
- ✓ Gentle washing and wiping of all surfaces
- ✓ Can be used for cleaning of hot surfaces up to temperatures of 200° C

Art.no. Case TSU	Description	Size in m	Pieces/pack	Packs/case	Art.no. Pack BCU	Application
142267	Sponge cloth "aqua"	18 x 20	5	14	142290	

### Quick 'n Dry



The Quick 'n Dry Roll is our fine sponge cloth featuring a nice touch and flexibility combined with high absorbency.

- ✓ Made from natural materials – 100% biodegradable
- ✓ High absorbency for efficient spill removal
- ✓ Lint-free cleaning results
- ✓ Economical – cloth length can be individually cut

Art.no. Case TSU	Description	Size in m	Pieces/pack	Packs/case	Art.no. Pack BCU	Application
100745	Quick 'n Dry Roll, blue	0.25 x 10	1	4	100746	

Wiping

Scouring

Gloves

Floor Cleaning

Brushware

Trolleys

Waste Management

# All-purpose and Semi-disposable Cloths



## WiPro (antibacterial)

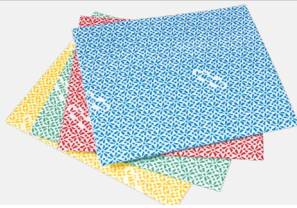

WiPro is our all-purpose wipe with antibacterial properties for maintaining good material condition.

- High absorbency for extensive spill removal
- Easy to rinse out particles
- Durable in use

Art.no. Case TSU	Description	Size in cm	Pieces/pack	Packs/case	Art.no. Pack BCU	Application
137000	WiPro (antibacterial), yellow	36 x 42	20	10	137004	
137001	WiPro (antibacterial), blue	36 x 42	20	10	137005	
137002	WiPro (antibacterial), green	36 x 42	20	10	137006	
137003	WiPro (antibacterial), red	36 x 42	20	10	137007	

## MicroTuff Easy



MicroTuff Easy is our semi-disposable microfibre wipe that comes in a handy dispenser box and highly fits all cleaning purposes.

- Made from extra-fine microfibres for very high cleaning performance
- Efficient removal even of fatty dirt
- Good absorbency for everyday use
- Good volume touch



Art.no. Case TSU	Description	Size in cm	Pieces/pack	Packs/case	Art.no. Pack BCU	Application
162710	MicroTuff Easy, blue	30 x 30	4	50	162711	
162712	MicroTuff Easy, red	30 x 30	4	50	162713	
162714	MicroTuff Easy, yellow	30 x 30	4	50	162715	
162716	MicroTuff Easy, green	30 x 30	4	50	162717	

## Breazy



Breazy is our semi-disposable wipe with a unique wave structure for excellent particle pick-up capabilities.

- Contains microfibres for good cleaning performance
- \*Up to 99.72% bacteria removal (P. aeruginosa & S. aureus) on vinyl surfaces at a 3rd party lab)
- Good and efficient absorbency for everyday use
- Very high volume touch
- Superior dirt storage capacity due to patented 3D structure



Art.no. Case TSU	Description	Size in cm	Pieces/pack	Packs/case	Art.no. Pack BCU	Application
161610	Breazy, blue	35 x 36	25	12	161616	
161611	Breazy, red	35 x 36	25	12	161617	
161613	Breazy, green	35 x 36	25	12	161619	
161612	Breazy, yellow	35 x 36	25	12	161618	

## GP Plus Cloth



GP Plus is our semi-disposable wipe with an increased volume touch for a hygienic and economical solution.

- Good and efficient absorbency for everyday use
- Easy to rinse out particles
- Good volume touch
- Fast drying for improved hygiene

Art.no. Case TSU	Description	Size in cm	Pieces/pack	Packs/case	Art.no. Pack BCU	Application
160720	GP Plus, green	35 x 35	25	6	160721	
160708	GP Plus, yellow	35 x 35	25	6	160709	
160706	GP Plus, red	35 x 35	25	6	160707	
160704	GP Plus, blue	35 x 35	25	6	160705	



# Above the Floor Cleaning Tools



## MultiDuster

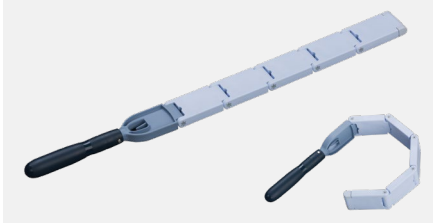

- Easy to wipe clean
- Doesn't harbour bacteria
- Slim design for narrow spaces
- Fits telescopic handles
- Can clean up to 5 m above floor

Art.no. Case TSU	Description	Size in cm	Pieces/pack	Pieces/case	Art.no. Pack BCU	Application
151612	MultiDuster Maxi Handle	66 (incl. handle)	1	10	151614	

## MultiDuster Maxi r-MicroPlus Pro Sleeve



- Hygienic cleaning of high or hard-to-reach areas
- Double-sided dusting sleeve to be used with the MultiDuster Maxi Handle
- Slim design for cleaning in tight spaces
- Unique 3-D honeycomb pile construction integrated with brush fibres for higher dirt pick-up capacity
- Up to 99.99% bacteria removal
- Made from up to 70% recycled material
- Awarded the Nordic Swan Ecolabel

Art.no. Case TSU	Description	Size in cm	Pieces/pack	Pieces/case	Art.no. Pack BCU	Application
171661	MultiDuster Maxi MicroPlus Sleeve (CC)	50	1	20	171662	

## Interior Cleaning Set



- Fast and efficient cleaning of interior surfaces such as glass walls, mirrors, stainless steel, blackboards, tables, etc.
- Pad Interior Auqapad:** Microfibre high-performance pad removes light soiling, e. g. fingerprints, quickly and easily, streak-free finish
- MicroSafety Handpad:** Microfibre pad with integrated all-over scrubbing zones for intensive wet-scrubbing of structured safety and slip resistant floors, even with micro-porous-surfaces such as un-glazed tiles to take away dirt out of the porous surface

Art.no. Case TSU	Description	Size in cm	Pieces/pack	Pieces/case	Art.no. Pack BCU	Application
175466	Pad Interior Aquapad	28 x 11	1	100		
150772	MicroSafety Handpad, grey	12 x 26	5	5	150775	
120542	Padboy Hand Tool	10.4 x 24.6	1	10	512992	
120544	Padmaster Edging Tool	24.6 x 10.4	1	10	512993	
111384	Telescopic Handle short	50 – 90	1	10	111389	



Wiping

Scouring

Gloves

Floor Cleaning

Brushware

Trolleys

Waste Management

# Evolution Window Cleaning

## Evolution Washer



- 180° handle fits 2 separate bars
- Adjustable position allows greater reach and easier access to difficult areas
- Microfibre washer features an agitation strip to help remove stubborn dirt

Art.no Case TSU	Description	Size in cm	Pieces/pack	Packs/case	Art.no. Pack BCU	Application
100235	Washer Complete	35	1	10	100812	
100236	Washer Complete	45	1	10	100813	
100241	Strip Sleeve	35	10	10	500207	
100242	Strip Sleeve	45	10	10	500208	

## Evolution Window Wiper



- 4 in 1 handle for all applications
- 30° standard inclination
- 180° swivel/straight for use with poles

Art.no Case TSU	Description	Size in cm	Pieces/pack	Packs/case	Art.no. Pack BCU	Application
100243	Window Wiper Complete	35	1	10	500209	
100244	Window Wiper Complete	45	1	10	500210	
100146	Rubber Hard	35	1	50	500113	
100147	Rubber Hard	45	1	50	500114	

## Evolution Telescopic Handle

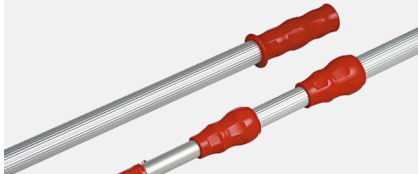

- Robust aluminum lightweight telescopic handle
- Ergonomic hand grip at the top
- Power grip collars for easy opening/closing even with wet hands
- O-Rings on cone provide extra stability

Art.no Case TSU	Description	Size in m	Pieces/pack	Packs/case	Art.no. Pack BCU	Application
100148	Telescopic Handle	2 x 1.25	1	10	500115	
100149	Telescopic Handle	2 x 2	1	10	500116	
100150	Telescopic Handle	3 x 2	1	10	500117	

## Evolution Safety Scraper



- Reduces the risk of cut hands
- Easy to use slide-out mechanism, retracts when not in use
- Hand-held or can be used with Evolution squeegees

Art.no Case TSU	Description	Size in cm	Pieces/pack	Packs/case	Art.no. Pack BCU	Application
100247	Evolution Safety Scraper	-	1	25	500213	
100248	Evolution Blades	-	25	10	100814	

## Evolution bucket



- 22 l capacity
- Manufactured from strong, durable plastic
- Ergonomic grip handle

Art.no. Case TSU	Description	Size	Pieces/pack	Packs/case	Art.no. Pack BCU	Application
100151	Evolution bucket (22 l)	22 l	1	10	500118	



# Scouring

Many scourers look alike on the outside, but if you choose one from Vileda Professional you will quickly notice the difference in terms of both quality and the end result. Poor quality scourers wear quickly once the top layer of abrasive fibres wears down, you are left with a scourer that demands more time and effort to get things clean. In a Vileda Professional scourer, every fibre is coated with grit and resin, his penetration of abrasive throughout the structure ensures superb cleaning action throughout the lifetime of the scourer. The strong resin-to-fibre bond ensures even wear of both fibres and abrasives, resulting in consistently excellent cleaning performance. Additionally Vileda Professional scourers are manufactured from nylon which does not rust, splinter, clog with debris and are easy to rinse clean.

# Scourers

## Vileda "Heavy Duty" (Black Abrasive)



- High performance, black abrasive scourer with easy grip foam backing
- Suitable for the heaviest duty applications
- Foam backing protects fingers and keeps the scourer flat for maximum contact with the cleaning surface

Art.no. Case TSU	Description	Size in cm	Pieces/pack	Packs/case	Art.no. Pack BCU	Application
101885	Vileda "Heavy Duty"	7 x 15	10	10	102565	

## Vileda "Strong" (Green Abrasive)



- High performance, high quality abrasive scourer with easy grip foam backing
- Ideal for general washing-up and mark removal
- Foam backing protects fingers and keeps the scourer flat for maximum contact with the cleaning surface

Art.no. Case TSU	Description	Size in cm	Pieces/pack	Packs/case	Art.no. Pack BCU	Application
101404	Vileda "Strong"	7 x 15	10	10	101397	

## Vileda Bathcleaner "Soft"



- Soft, blue structure, more effective at removing marks than white scourers, but still gentle to surfaces
- Ideal for use in sanitary applications
- Foam backing protects fingers and keeps the scourer flat for maximum contact with the cleaning surface
- Available in two formats

Art.no. Case TSU	Description	Size in cm	Pieces/pack	Packs/case	Art.no. Pack BCU	Application
100082	Vileda Bathcleaner	7 x 15	10	10	100729	
161371	Vileda Bathcleaner	13 x 16.5	1	44	535895	

## Vileda "Non-Scratch"



- Open soft white scourer surface does not contain abrasive, making it suitable for non-scratch cleaning on all surfaces
- Ideal for use in bathrooms, kitchen, etc.
- Foam backing protects fingers
- Colour coded R/B/G/Y to help prevent cross contamination
- Universally applicable, also on chrome

Art.no. Case TSU	Description	Size in cm	Pieces/pack	Packs/case	Art.no. Pack BCU	Application
101882	Vileda "Non-Scratch", blue	7 x 15	10	10	102562	
101883	Vileda "Non-Scratch", red	7 x 15	10	10	102563	
101884	Vileda "Non-Scratch", yellow	7 x 15	10	10	102564	
101881	Vileda "Non-Scratch", green	7 x 15	10	10	102561	

# Handpads

## Handpads & Handpads Standard Light



- Scouring fleece with high level cleaning performance
- Hygienic
- Available in three grades
- Usable with or without padholder
- Pad thickness 7 mm

Art.no. Case TSU	Description	Size in cm	Pieces/pack	Packs/case	Art.no. Pack BCU	Application
163158	Handpad black "Heavy Duty"	15 x 22	10	10	163172	
108817	Handpad green "Strong"	15 x 22	10	10	106442	
163171	Handpad green "Strong" for padholder	12 x 26	10	5	163175	
106049	Handpad white "Non-Scratch"	15 x 22	10	10	108727	
106048	Handpads Standard Light, green	16 x 21	10	10	108726	

## Abrasive Roll



- High performance, high quality abrasive scourer
- Ideal for general washing-up and mark removal
- Roll of 6 m without perforation

Art.no. Case TSU	Description	Size in cm	Pieces/pack	Packs/case	Art.no. Pack BCU	Application
100232	Abrasive Roll	600 x 14	1	6	100810	

# PurActive

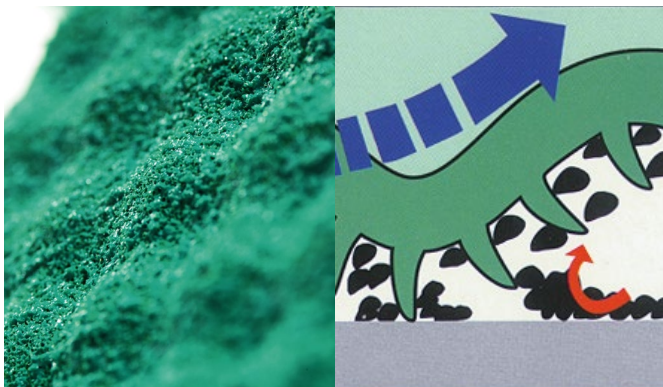

### Effect of PurActive wave-shape

PurActives special coating easily lifts stubborn grime whilst being gentle on all hard surfaces. It cleans three times more effectively than traditional non-scratch scourers and is more gentle on surfaces than a traditional abrasive scourer.

Instead of scratching the dirt away like a traditional scourer, the special wave shaped surface structure lifts the dirt from the surface without scratching resulting in time savings through faster more powerful cleaning.

## PurActive



- Easily lifts grease and grime
- Gentle on all hard surfaces
- Fits comfortably in your hand
- Colour coded to help prevent cross contamination

Art.no. Case TSU	Description	Size in cm	Pieces/pack	Packs/case	Art.no. Pack BCU	Application
123114	PurActive, blue	6,3 x 14	10	10	123118	
123112	PurActive, red	6,3 x 14	10	10	123116	
123113	PurActive, yellow	6,3 x 14	10	10	123117	
123111	PurActive, green	6,3 x 14	10	10	123115	



# Inox Scourers

Stainless steel scourers from Vileda Professional are perfect for intensive scouring and removal of stubborn dirt.

## Inox Metallic Scourer



- Manufactured from stainless steel
- Very resistant and durable
- For intensive scouring and removal of stubborn dirt
- Easy to rinse

Art.no. Case TSU	Description	Size in cm	Pieces/pack	Packs/case	Art.no. Pack BCU	Application
142352	Inox Metallic Scourer 20 g	-	3	10	122595	
100200	Inox Metallic Scourer 40 g	-	1	50	100787	
100201	Inox Metallic Scourer 60 g	-	1	50	100788	

## PowerInox



- Scouring pad for intensive removal of the most stubborn dirt and grease in pots and pans
- Non-rusting, stainless steel wire is embedded in knitted Polyester fabric
- Absorbent and easy to rinse out
- Long lasting, keeps its shape
- Reduced particle loss up to the minimum

Art.no. Case TSU	Description	Size in cm	Pieces/pack	Packs/case	Art.no. Pack BCU	Application
163101	PowerInox Pack4	10 x 10.5	4	12	163102	

# Miraclean

Tired of pen-marked table tops, scuff-marked floors, limy washbasins, dirty white-boards, greasy sinks, finger printed walls, and ground-in dirt in general?

Miraclean is the solution to all these problem areas. With a minimum of effort and using only water it will instantly take away marks that used to be a problem. No need for aggressive chemicals, no need to struggle and sweat over annoying marks anymore, just dampen Miraclean in water and rub the mark away.



## Miraclean (Stain Eraser)

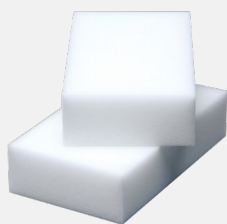

- Strong cleaning performance with a minimum of effort
- Works with water only, no chemicals needed
- About 26 times more effective than other methods or products, saves time and money



Art.no. Case TSU	Description	Size in cm	Pieces/pack	Packs/case	Art.no. Pack BCU	Application
102750	Miraclean	10 x 6 x 2,8	12	12	102751	
113034	Miraclean	12 x 7.5 x 3.8	8	12	113035	



# Gloves

Chemical or mechanical hazards, heavy-duty cleaning, microbiological hazards, and foodstuff handling – the directives for Personal Protective Equipment (PPE) are clear: employees have to provide their staff with appropriate protection against hazards.

Vileda Professional gloves are the answer to the various needs to meet the different professional cleaning needs as well as the legal requirements. Vileda Professional offers a complete range of protective and comfortable gloves, each suitable for its respective professional task.

Wiping

Scouring

Gloves

Floor Cleaning







Brushware

Trolleys

Waste Management

To optimize glove economy – as a part of your total cleaning costs – be sure to select the right glove for the job. As each glove has its top protection focus it's easy to select the most suitable one, and thereby investing in exactly the right performance you expect from the glove.

## Labeling Symbols

Symbol	Pictogram meaning	Information
 <small>A B C D E EN 388:2016</small>	<b>Mechanical Protection</b> The glove has a mechanical protection tested acc. to EN 388 Test result is a 5 digit code A B C D E with values from 0 to 4 or 5 and from A to F (0 or A = low, 4/5 or F = high, X = not performed or not applicable)	A: Abrasion resistance (performance levels 0 to 4) B: Blade cut resistance (performance levels 0 to 5) C: Tear resistance (performance levels 0 to 4) D: Puncture resistance (performance levels 0 to 4) E : TDM ISO EN 13997 cut resistance (performance levels A to F)
 <small>A B C D E F G H I J K L M N O P S T EN ISO 374-1:2016 / Type A, B or C</small>	<b>Chemical Protection</b> The glove has a chemical protection tested acc. to EN ISO 374 Test is performed against a chemical list of 18 standard chemicals	Type A = chemical breakthrough time > 30 minutes against at least 6 chemicals from the list Type B = chemical breakthrough time > 30 minutes against at least 3 chemicals from the list Type C = chemical breakthrough time > 10 minutes against at least one test chemical from the list (no code underneath the pictogram) Please check table "Chemical Recommendation" in catalogue or ask for technical support! Vileda Professional gloves are sufficient to and protect against diluted common cleaning agents. Water/Air-leak tested (AQL ≤ 1,5)
 <small>EN ISO 374-5: 2016</small>	<b>Protection from Microorganisms</b> The glove has a bacteria and fungi protection tested acc. to EN ISO 374	Protection against bacteria and fungi, not tested against virus
 <small>VIRUS EN ISO 374-5: 2016</small>	<b>Protection from Microorganisms</b> The glove has a bacteria, fungi and virus protection tested acc. to EN ISO 374	Protection against bacteria, fungi and virus
	<b>Glass &amp; fork symbol</b> The glove is suitable for food contact	
	<b>Info booklet</b> For further information, please contact Vileda Professional	







## Nitrile Gloves

- Highly protective gloves against chemicals and detergents up to high chemical risk
- Best in class resistance against oily, fatty components and hydrocarbons
- Latex-free gloves for users with latex allergy
- Protection against bacteria and viruses

### Universal



Latex-free nitrile glove suitable for cleaning tasks with intense chemical use. Ideal also for food handling.

- Strong chemical resistance against a wide range of chemicals, oils and solvents combined with high mechanical resistance
- High dexterity and finger sensibility
- Pure cotton flock lined for comfort in use
- Latex-free, no risk of latex allergies
- Applicable for food contact
- Protection against bacteria and viruses

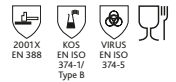

Art.no. Case TSU	Description	Size	Pair/pack	Packs/case	Art.no. Pack BCU	Application
174378	Universal	S, 6 – 6½	1	50	174379	
174380	Universal	M, 7 – 7½	1	50	174381	
174382	Universal	L, 8 – 8½	1	50	174383	
174384	Universal	XL, 9 – 9½	1	50	174385	

### LiteTuff – Disposable glove



Disposable latex-free, low dermatitis potential and powder-free nitrile glove. Ideal for applications requiring an often glove change. Best for food handling.

- Sensitive tactile feel, flexibility and comfort
- Low dermatitis potential, latex-free and powder-free nitrile glove
- Suitable for latex sensitive wearers or persons with sensitive skin (contact dermatitis)
- Packed in practical dispenser box
- Protection against bacteria and viruses

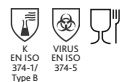

Art.no. Case TSU	Description	Size	Pieces/pack	Packs/case	Art.no. Pack BCU	Application
137964	LiteTuff	S, 6½ – 7	100	10	137975	
137966	LiteTuff	M, 7½ – 8	100	10	137976	
137967	LiteTuff	L, 8½ – 9	100	10	137977	
137968	LiteTuff	XL, 9½ – 10	100	10	137978	

Wiping

Scouring

Gloves

Floor Cleaning

Brushware

Trolleys

Waste Management



## Latex Gloves

- ✓ Highly elastic and flexible gloves
- ✓ High sensitivity and tactility in use
- ✓ Good protective gloves against chemicals and detergents from low to high risk
- ✓ Protection against bacteria and viruses









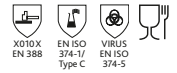



### Contract



Extra thin, entry level natural latex glove for everyday cleaning and general cleaning tasks.

- ✓ High dexterity and finger sensibility
- ✓ Convenient natural latex glove
- ✓ Pure cotton flock lining for comfort in use



Art.no.	Case TSU	Description	Size	Pair/pack	Packs/case	Art.no. Pack BCU	Application
174320		Contract	S, 6 – 6½	1	50	174321	  
174322		Contract	M, 7 – 7½	1	50	174323	  
174324		Contract	L, 8 – 8½	1	50	174325	  
174326		Contract	XL, 9 – 9½	1	50	174327	  









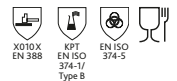



### LightWeight



Unlined natural latex glove for cleaning tasks requiring control and feel of items.

- ✓ Offering strong dexterity and sensibility
- ✓ High tactility and flexibility in use
- ✓ High tear resistance
- ✓ Smooth inside coating for easy donning



Art.no.	Case TSU	Description	Size	Pair/pack	Packs/case	Art.no. Pack BCU	Application
174310		LightWeight	S, 6 – 6½	1	50	174311	  
174312		LightWeight	M, 7 – 7½	1	50	174313	  
174314		LightWeight	L, 8 – 8½	1	50	174315	  
174316		LightWeight	XL, 9 – 9½	1	50	174317	  



## MultiPurpose

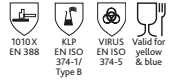

Natural latex glove suitable for allround cleaning tasks. Available in 4 colours.

- High durability natural latex glove offering excellent cost efficiency and high anatomical comfort in use
- Good chemical resistance against detergents and cleaning chemicals
- Pur cotton flock lining for comfort in use
- Colour-coded for maximum safety in fulfilling hygiene requirements
- Protection against bacteria and viruses

Art.no. Case TSU	Description	Size	Pair/pack	Packs/case	Art.no. Pack BCU	Application
174340	MultiPurpose, red	S, 6 – 6½	1	50	174341	
174342	MultiPurpose, red	M, 7 – 7½	1	50	174343	
174344	MultiPurpose, red	L, 8 – 8½	1	50	174345	
174346	MultiPurpose, red	XL, 9 – 9½	1	50	174348	
174349	MultiPurpose, blue	S, 6 – 6½	1	50	174350	
174352	MultiPurpose, blue	M, 7 – 7½	1	50	174353	
174354	MultiPurpose, blue	L, 8 – 8½	1	50	174355	
174356	MultiPurpose, blue	XL, 9 – 9½	1	50	174357	
174360	MultiPurpose, green	S, 6 – 6½	1	50	174361	
174362	MultiPurpose, green	M, 7 – 7½	1	50	174363	
174364	MultiPurpose, green	L, 8 – 8½	1	50	174365	
174366	MultiPurpose, green	XL, 9 – 9½	1	50	174367	
174368	MultiPurpose, yellow	S, 6 – 6½	1	50	174369	
174371	MultiPurpose, yellow	M, 7 – 7½	1	50	174372	
174373	MultiPurpose, yellow	L, 8 – 8½	1	50	174375	
174376	MultiPurpose, yellow	XL, 9 – 9½	1	50	174377	

## SafeGrip

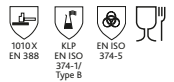

Natural latex glove with raised grip pattern. Suitable for wet cleaning tasks requiring increased grip.

- Natural latex glove offering outstanding grip under wet and dry conditions due to special grip pattern and wax treatment
- Good chemical resistance against detergents and cleaning chemicals
- Pure cotton flock lining for comfort in use

Art.no. Case TSU	Description	Size	Pair/pack	Packs/case	Art.no. Pack BCU	Application
174330	SafeGrip	S, 6 – 6½	1	50	174333	
174334	SafeGrip	M, 8 – 8½	1	50	174335	
174336	SafeGrip	L, 9 – 9½	1	50	174337	
174338	SafeGrip	XL, 9½– 10	1	50	174339	

## HeavyWeight

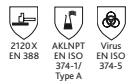

3 layer extra resistant Latex-Neoprene blended glove. Ideal for tough cleaning tasks with strong chemicals in use.

- Durable glove, perfect for in depth cleaning and special cleaning tasks
- Excellent wear and tear resistance combined with perfect grip
- Pure cotton flock lining for wearing comfort
- Protection against bacteria and viruses

Art.no. Case TSU	Description	Size	Pair/pack	Packs/case	Art.no. Pack BCU	Application
174302	HeavyWeight	S, 6 – 6½	1	50	174303	
174304	HeavyWeight	M, 7 – 7½	1	50	174305	
174306	HeavyWeight	L, 8 – 8½	1	50	174307	
174308	HeavyWeight	XL, 9 – 9½	1	50	174309	

Wiping

Scouring

Gloves

Floor Cleaning

Brushware

Trolleys

Waste Management

Chemical recommendation			Nitrile			Latex				
Chemicals	Conc. in %	CAS-No.	Comfort	Universal	Protect	Contract	MultiPurpose	SafeGrip	LightWeight	HeavyWeight
Acetic acid	50	64-19-7	3	4	5	4	5	5	5	6
Acetone	100	67-64-1	0	0	0	0	0	0	0	0
Alcohol (C12-C16) ethoxylates	15	68213-23-0	6	6	6	6	6	6	6	6
2-Butoxyethanol	20	111-76-2	5	6	6	2	0	1	1	3
Citric acid aqueous solution	50	77-92-9	6	6	6	6	6	6	6	6
Diethylamine	25	109-89-7	0	1	1	0	0	0	0	0
Ethanol	20	64-17-5	6	6	6	5	5	6	6	6
Alcohol (C12-C14) ethoxylates	15	68439-50-9	6	6	6	6	6	6	6	6
Formaldehyde	25	50-00-0	6	6	6	6	6	6	6	6
Formic acid	85	64-18-6	1	2	3	2	3	3	3	4
Glutaraldehyde, aqueous solution	25	111-30-8	6	6	6	6	6	6	6	6
Hydrochloric acid	37	7647-01-0	4	6	6	4	3	5	5	6
Hydrogen peroxide	30	7722-84-1	4	6	6	5	6	6	6	6
Isopropanol	70	67-63-0	3	4	6	3	1	1	1	4
Phosphoric acid	30	7664-38-2	6	6	6	6	6	6	6	6
Potassium hydroxide	30	1310-58-3	6	6	6	6	6	6	6	6
Quaternary ammonium compounds	15	106233-03-8	6	6	6	6	6	6	6	6
Sodium dodecylsulfate, sat. solution	15	151-21-3	6	6	6	6	6	6	6	6
Sulfamic acid, sat. solution	20	5329-14-6	6	6	6	5	6	6	6	6
Turpentine (oil)	100	8006-64-2	4	6	6	0	0	0	0	0

Any recommendations given in the table enclosed are based on results of laboratory tests or are based on extrapolations from the results of laboratory tests. These tests were run using standard test methods that may not adequately replicate any specific conditions of end use. Any of these data must be advisory only.

Permeation breakthrough times according to EN ISO 374 (minutes)

0	1	2	3	4	5	6
<10'	10-30'	30-60'	60-120'	120-240'	240-480'	>480'
Not recommended	Splash protection		Medium protection		High protection	

## How to use gloves



### 1. Before putting on gloves

Clean and dry your hands thoroughly before putting on gloves.

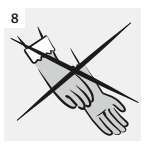

### 2. Do not reuse damaged gloves

Please use only gloves which do not have any damages like holes or tears.

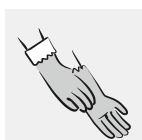

### 3. How to put on gloves

Please turn the cuffs in order to prevent liquids to flow into the glove.



### 4. Usage duration

Do not use one pair of gloves for too long: please check the chemical recommendation, alternate between 2-3 pairs if long time use is required.



### 5. Clean gloves after usage

Please clean the gloves before taking them off: after contact with acid or alkaline chemicals please wash off with water and dry afterwards.



### 6. How to take off gloves

Please do not touch the outer side of the gloves while taking them off: avoid contact to chemicals / bacteria.

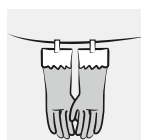

### 7. How to store used gloves

Take care that the used gloves dry properly until next use by e.g.: putting the gloves on a gloves rack, hanging the gloves on a (clothes) line.

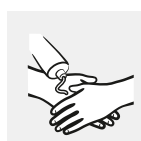

### 8. Hand care after usage

After taking off the gloves, please wash your hands and use a suitable hand cream.



Wiping

Scouring

Gloves

Floor Cleaning

Brushware

Trolleys

Waste Management

# Floor Cleaning

As all sites differ in terms of size, floor coverings, traffic volume, hygiene and health and safety requirements, a single floor cleaning system is not enough to fulfil all requirements. That's why Vileda Professional offers a comprehensive range of sustainable and durable single-use solutions that are customised to your exact requirements. From the 1-step pre-cleaned Swep system and the 2-step Twixterclass cleaning system to the UltraSpeed Pro, UltraSpeed Mini or UltraSpin Mini bucket and pressure systems and SuperMop. By choosing the right system for your needs, you can achieve better performance and ergonomics, reduce your total cost of ownership and improve your sustainability goals.



## WetDryCleaning

All in one twist with Twixter! The leading floor cleaning system for 2-step cleaning, invented to clean all floors wet and dry in one operation. Based on its double-sided mops it works up to 30% faster, compared to a single sided mop.

40m<sup>2</sup>

### Double the floor coverage

Cover up to 40m<sup>2</sup> per mop before changing in 1-step cleaning mode. Double the distance of single sided systems.



### Highest Hygiene

Never touch a used mop. Release the mop safely and hygienically at the push of a button.



### Faster Cleaning

Double sided mopping means more time cleaning and less time changing mops or wringing.



### All areas and methods

Use with Des Tub for 2-step cleaning, or with a press in large areas respective pre-prepared in hygiene sensitive areas.

# One Twixter Different Methods

Whatever your method of choice do it with Twixter

## DES TUB SYSTEM

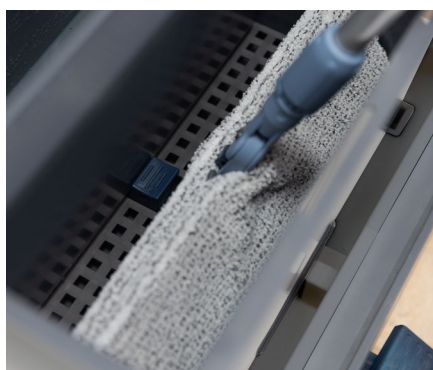

### 2-Step Wet & Dry Cleaning

#### Easy to train

Simple, intuitive and fast handling

#### Perfectly soaked

Mop moistening of one or both mop sides

#### Hygienic

No contamination of cleaning solution and spreading of germs

## BUCKET & PRESS / PRE-PREPARED SYSTEM



### 1-Step Wet Cleaning

#### Double the floor coverage

Cover up to 40 m<sup>2</sup> per mop before changing in 1-step cleaning method. Double the distance of single sided systems.

#### Faster Cleaning

Double sided mopping means more time cleaning and less time changing mops or wringing.



### Sweep Pre-Prepared Flat Mop System

The original Sweep pre-prepared system was launched over 40 years ago. During this period the system has continually developed to stay ahead of the changing trends and demands from the marketplace. The new Sweep class is the latest upgrade focusing on sustainability, ergonomics and cleaning performance. A new range of handles, frames and mops made from recycled materials, backed up by external ergonomics certificates and with proven bacteria and virus removal.



### Twixter

Twixter – the innovative solution for hands-free, hygienic cleaning. The Twixter’s unique double mop design allows for both wet and dry mopping with a single mop, offering versatility and efficiency. Available in various mop qualities to suit every cleaning need, the 40 cm wide Twixter is perfect for tackling large surface areas. Its ergonomic design enables all cleaning tasks to be performed in an upright position, ensuring maximum comfort and ease of use. The Twixter sets a new standard in efficient and hygienic floor cleaning.

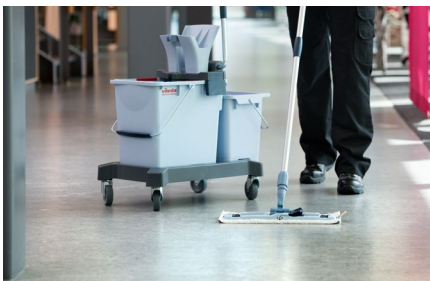

### UltraSpeed Pro Flat Mop System

Ultra Speed Pro is the most up to date, best performing flat Mop Bucket and press system on the market. It is so easy to use, needs no training and is adaptable to suit all sites. Start with the single Bucketsystem for general floor cleaning or add a second Bucket onto the chassis and you have a double Bucketsystem for mopping larger areas. If you want to fulfil more cleaning tasks, you can use the second Bucket to carry chemicals, cloths, paper etc. Whatever the cleaning requirements, UltraSpeed Pro will dramatically raise your standards in speed, performance/costs, versatility and ergonomics.



### CombiSpeed Pro System

The CombiSpeed Pro system includes a wide assortment of pocket and strip Mops for use in a variety of applications. From the high performance of Trio and MicroSpeed Plus to the economy of Contract and MicroLite we have a Mop that meets your requirements in terms of application, performance or budgets. Each Mop type is available in 40 cm and 50 cm sizes in both pocket and pocket/strip attachments and fit all commercially frames. Additional features also include barcode labels and colour coding tags as standard.



### Express (Hook and Loop) Flat Mops

Comprehensive range of hook and loop Mops for use with a variety of systems and methods including pre-prepared, spray and dust control.



### ClickSpeed Pre-Prepared System

ClickSpeed is a cost effective pre-prepared damp flat mopping system featuring a unique, patented mop frame that is very easy to handle and use. Simply drop the mop on the floor, slide in the frame and then click-close the magnetic mop holder. ClickSpeed can be used with either microfiber durable mops or with microfiber based single use mops.





### SprayPro Inox Spray Mopping System

SprayPro Inox is the professional, ready-to-use floor cleaning system containing all you need for Bucketfree mopping. Just fill the handle with water and you have everything you need to clean hard flooring and staircases in one easy-to-use unit. Designed to work with all Vileda Professional mopping systems it easily adapts to your needs, whatever the cleaning task or on-site conditions.



### Vertical mopping systems

A traditional system in the wet mopping is still the vertical Mop assortment. Vileda Professional offers a range which fits all needs, from the innovative UltraSpin Mini to a small and flexible system with several Mop materials in the SuperMop range to a traditional Kentucky Mop system up to a Twist Mop which could be used without any press.

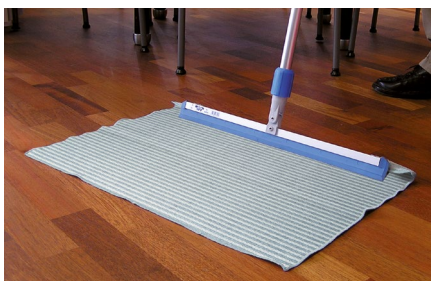

### Floor Cloths

High performance durable and single use floor cloths featuring the quality and performance you expect from Vileda Professional. For use with your choice of squeegees or scrubbers on all hard floors.



### Dustmopping

The disposable dustmop range comprises a range of viscose and polypropylene non-woven Mops that contain a special permanent oil impregnation treatment that retains its effectiveness even after storing for long periods. The durable dustMops are designed for fast removal of loose dust and dirt as part of daily maintenance or preliminary cleaning. When used as part of a maintenance system dustmopping acts as an intermediate cleaning step to reduce the frequency of wet or damp mopping.



### Floorpads

Superpads are designed to last longer, do the job faster, prolong the life of floor coatings and protect your investment in floorcare machinery. Available in a range of grades and sizes for all motor speeds. Edging Tools & Pads are designed to simplify cleaning, maintenance, restoring and manual spot-cleaning processes. For use in areas inaccessible to machines including corners, walls, floor edges and staircases.

Wiping

Scouring

Gloves

Floor Cleaning

Brushware

Trolleys

Waste Management

# The New Sweep Class

Synchronized cleaning, ultimate success.  
For offices, public buildings and healthcare facilities.

Meet the most efficient, high-performing floor cleaning system to date from Vileda Professional.  
Highest efficiency synchronized with superior cleaning results at a minimized impact on the environment.  
For ultimate success.

## Sweep to ultimate hygiene.

Clean deeper. With better results.

Up to 99.9% of virus and bacteria removal –  
synchronized with a decreased use of water and chemicals.



## Sweep to superior ergonomics.

Clean faster. With better ergonomics.

Versatility in size and use, symmetrical frame and mop design –  
synchronized as a certified ergonomic system.



## Sweep to sustainability.

Clean easier. With a greener impact.

Recycled materials in high-performance mops –  
synchronized with second life plastic in handles and frames.



## Sweep to a lower cost-in-use.

Clean smarter. With lower overall costs.

Durable, pre-prepared, double-sided mops designed with high-tech  
fibres to clean more square meters with fewer mops.



# Swep System

The original Swep pre-prepared system was launched over 40 years ago. During this period the system has continually developed to stay ahead of the changing trends and demands from the marketplace. The new Swep class is the latest upgrade focusing on sustainability, ergonomics and cleaning performance. A new range of handles, frames and mops made from recycled materials, backed up by external ergonomics certificates and with proven bacteria and virus removal.



## The Core Range – Swep Duo

By being double sided Swep Duo Mops let you clean twice the area by just flipping the frame and keep mopping. Plus you only need to purchase and to launder half the number of Mops – meaning lower investments and lower usage of water, chemicals and electricity.



### Swep r-Frame



#### Symmetrical, Ergonomic Design

- ✓ Two frame sizes for floors, walls, open areas and all surface types
- ✓ Symmetrical, hygienic design with hand grips and peelers for easy mop on / off
- ✓ Flat construction for even, consistent contact with cleaning surface
- ✓ Compatible with all Swep mops
- ✓ Plastica Seconda Vita Certified due to recycled plastic construction
- ✓ ErgoCert certified for superior ergonomics when used with Swep Pro mops and with the Ergonomic or Telescopic Handle

Art.no. Case TSU	Description	Size in cm	Pieces/pack	Packs/case	Art.no. Pack BCU	Application
171332	Swep r-Frame	35	1	10	171336	
171333	Swep r-Frame	50	1	10	171337	
111384	Telescopic Handle, blue	50 – 90	1	10	111389	
171340	Swep Ergo Handle, blue	100 – 180	1	10	171342	
111380	Universal Telescopic Handle, blue	100 – 180	1	10	111385	
111529	Aluminum Handle, Clip blue	150	1	10	506267	

### Swep Ergo Handle



#### Ergonomic Design for Efficient Floor Cleaning

- ✓ Rotating ball-grip and grip stop ensure ergonomic usage
- ✓ 3-Star ErgoCert certified when used with Swep Pro mops and Swep r-Frames
- ✓ Compatible with all Swep mops
- ✓ Plastica Seconda Vita certified due to recycled plastic construction
- ✓ ErgoCert certified for superior ergonomics when used with Swep Pro mops and Swep handles

Art.no. Case TSU	Description	Colour	Pieces/pack	Packs/case	Art.no. Pack BCU	Application
171340	Swep Ergo Handle	Blue	1	10	171342	

Wiping

Scouring

Gloves

Floor Cleaning

Brushware

Trolleys

Waste Management

## r-MicroTech Swep Duo



### Fast Cleaning of Smooth Floors

- Microfibre technology for optimum durability and cleaning performance without aggressive chemicals
- Up to 99.99% virus\* and bacteria removal (\*Tested with bovine coronavirus on vinyl surfaces at a 3<sup>rd</sup> party lab)
- Highly durable
- Mop is made from up to 30% recycled materials – recycled polyester (postconsumer)
- Nordic Swan Ecolabel (pending)

Art.no. Case TSU	Description	Size in cm	Pieces/pack	Packs/case	Art.no. Pack BCU	Application
169375	r-MicroTech Swep	50	1	25	169376	

## Swep Duo r-MicroPlus Pro



### Thorough Cleaning of Structured Floors

- Unique, reinforced 3D-structured pile that adapts to different levels in structured floors for superior floor cleaning without aggressive chemicals
- Up to 99.9% virus\* and bacteria removal (\*external lab certificate pending)
- Highly durable
- Made with up to 50% recycled materials in the complete mop
- New symmetrical design with numbered finger loops for guided cleaning
- Nordic Swan Ecolabel (pending)

Art.no. Case TSU	Description	Size in cm	Pieces/pack	Packs/case	Art.no. Pack BCU	Application
171374	Swep Duo r-MicroPlus Pro	50	1	30	171375	

## Swep Duo r-MicroCombi Pro



### All in one: Excellent Cleaning of All Floor Types

- Unique combination of reinforced 3D-structured pile that adapts to different levels in all floors with a fringe for large particle pick-up for superior floor cleaning without aggressive chemicals
- Up to 99.9% virus\* and bacteria removal (\*external lab certificate pending)
- Highly durable
- Made with up to 50% recycled materials in the complete mop
- New symmetrical design with numbered finger loops for guided cleaning
- Nordic Swan Ecolabel (pending)

Art.no. Case TSU	Description	Size in cm	Pieces/pack	Packs/case	Art.no. Pack BCU	Application
171411	Swep Duo r-MicroCombi Pro	50	1	30	171412	

## Swep Duo r-SafetyPlus Mop



- Double-sided mop with one scrubbing side for loosening dirt and one microfibre side for dirt collection
- Made from up to 35% recycled material on the microfibre pile side
- Up to 99.99% bacteria removal tested with P.aeruginosa & S.aureus on vinyl surfaces at a 3<sup>rd</sup> party lab
- High durability
- Made from up to 35% recycled material on the microfibre pile side
- New symmetrical design with numbered finger loops for guided cleaning
- Awarded the Nordic Swan Ecolabel

Art.no. Case TSU	Description	Size in cm	Pieces/pack	Packs/case	Art.no. Pack BCU	Application
171609	Swep Duo r-SafetyPlus Mop	50	1	30	171650	



## Swept Duo HygienePlus Pro



No Need to Tumble Dry

- Unique, reinforced 3D-structured pile that adapts to different levels in all floors
- \*Can be stored in damp conditions after washing for up to 72 hours
- No need to tumble dry after laundering
- Microfibres with embedded preservative silver phosphate glass in the cut pile material
- Available in Single- and Duo-sided formats



Art.no. Case TSU	Description	Size in cm	Pieces/pack	Pieces/case	Art.no. Pack BCU	Application
171427	Swept Duo HygienePlus Pro	50	1	30	171428	 

## Swept Wall and Interior Mop



- Hygienic cleaning of whiteboards, walls and interiors
- Double-sided mop effectively cleans all hard above the floor surfaces
- Distributes moisture evenly and leaves behind only minimal water particles
- For use with the mop holder 35 cm
- Removes up to 99.99% of bacteria from surfaces (tested at a 3<sup>rd</sup> party lab)
- Made from recycled microfibers



Art.no. Case TSU	Description	Size in cm	Pieces/pack	Pieces/case	Art.no. Pack BCU	Application
173108	Swept Wall and Interior Mop	35	1	10	173109	 

# Swept Single System

Areas with less than 20 m<sup>2</sup>. Duo Mops offer the best cost in use through laundry, dosing and preparation time. But there are some areas that are too small to benefit from the second side. E.g. patient rooms often measure around 20 m<sup>2</sup>. To fulfil these requirements the Mops in the core range are available as 50 cm Single sided Mops.

## r-MicroTech Swept Single



Fast Cleaning of Smooth Floors

- Microfibre technology for optimum durability and cleaning performance without aggressive chemicals
- Up to 99.99% virus\* and bacteria removal (\*Tested with bovine coronavirus on vinyl surfaces at a 3<sup>rd</sup> party lab)
- Highly durable
- Mop is made from up to 30% recycled materials – recycled polyester (post-consumer)
- Nordic Swan Ecolabel (pending)



Art.no. Case TSU	Description	Size in cm	Pieces/pack	Packs/case	Art.no. Pack BCU	Application
169361	r-MicroTech Swept Single	50	1	10	169362	 



## Swept Single r-MicroCombi Pro



All in one: Excellent Cleaning of All Floor Types

- Unique combination of reinforced 3D-structured pile that adapts to different levels in all floors with a fringe for large particle pick-up for superior floor cleaning without aggressive chemicals
- Up to 99.9% virus\* and bacteria removal (\*external lab certificate pending)
- Highly durable
- Made with up to 35% recycled materials in the complete mop
- New symmetrical design with finger loops for guided cleaning
- Nordic Swan Ecolabel (pending)



Art.no. Case TSU	Description	Size in cm	Pieces/pack	Packs/case	Art.no. Pack BCU	Application
171413	Swept Single r-MicroCombi Pro	50	1	30	171414	 

Wiping

Scouring

Gloves

Floor Cleaning

Brushware

Trolleys



Waste Management

## Swept Single r-MicroPlus Pro



### Thorough Cleaning of Structured Floors

- Unique, reinforced 3D-structured pile that adapts to different levels in structured floors for superior floor cleaning without aggressive chemicals
- Up to 99.9% virus\* and bacteria removal (\*external lab certificate pending)
- Highly durable
- Made with up to 35% recycled materials in the complete mop
- New symmetrical design with finger loops for guided cleaning
- Nordic Swan Ecolabel (pending)



Art.no. Case TSU	Description	Size in cm	Pieces/pack	Packs/case	Art.no. Pack BCU	Application
171376	Swept Single r-MicroPlus Pro	50	1	30	171377	 

## Swept Single HygienePlus Pro



### No Need to Tumble Dry

- Unique, reinforced 3D-structured pile that adapts to different levels in all floors
- \*Can be stored in damp conditions after washing for up to 72 hours
- No need to tumble dry after laundering
- Microfibres with embedded preservative silver phosphate glass in the cut pile material
- Available in Single- and Duo-sided formats





Art.no. Case TSU	Description	Size in cm	Pieces/pack	Pieces/case	Art.no. Pack BCU	Application
171429	Swept Single HygienePlus Pro	50	1	30	171430	 

## MicroControl Mop



- 100 % microfibre Mop offering cleaning performance
- The patented edge cleaning lip design allows for effective cleaning of corners, skirt boards etc.
- Straight and clean design with no dirt traps
- Multilayer design with sealed edges for high absorbency, low particle shedding and top stability
- Ergonomic performance and high efficiency due to the Vileda pre-prepared method
- One cleaning tool for floors, walls and ceilings





Art.no. Case TSU	Description	Size in cm	Pieces/pack	Packs/case	Art.no. Pack BCU	Application
149000	MicroControl Mop	35	1	10	528740	 
140708	MicroControl Mop	50	1	30	523471	 

## Swept Single Micromop



- The strong mop for cleaning hard floors
- Micro sling mop made of a microfibre-polyester blend
- Due to reduced particle emission especially suitable for special applications, such as clean room cleaning
- Strong mechanical cleaning effect and fine dirt absorption



Art.no. Case TSU	Description	Size in cm	Pieces/pack	Packs/case	Art.no. Pack BCU	Application
114450	Swept Single Micromop	35	1	30	508436	
114451	Swept Single Micromop	50	1	30	508437	



# Twixter

Two steps feel like one!

With Twixter! The leading floor cleaning system for 2-step cleaning, invented to clean all floors wet and dry in one operation. Based on its double-sided mops it works up to 30% faster, compared to a single sided mop. Use with Des Tub for 2-step cleaning, or 1-step cleaning with a press in large areas respective pre-prepared in hygiene sensitive areas.

## Twixter Frame



- ✓ Designed for two-sided mopping, frame can be flipped to the other side
- ✓ 2-step approach with the DesTub 35 l: Efficient wet and dry cleaning in one operation
- ✓ For pre-prepared cleaning in hygiene sensitive areas (e.g. patient rooms) for reduced chemical and water consumption
- ✓ Use with the Twixter Flat press in high traffic areas (e.g. canteens) for heavy dirt removal
- ✓ Ergonomic working without bending down and push button for hands free mop release
- ✓ For floor and side wall cleaning

Art.no. Case TSU	Description	Size in cm	Pieces/pack	Packs/case	Art.no. Pack BCU	Application
175276	Twixter frame	40	1	10	175276	  

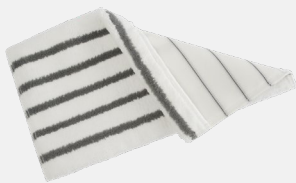

## Brush Progressive



3D structured mop for outstanding dirt loosening and removal

- ✓ High cleaning performance and good gliding properties
- ✓ Bristle strips also clean grouting thoroughly
- ✓ Low friction on safety tiles and perfect hair removal
- ✓ Wet cleaning of heavily structured floors
- ✓ Up to 300 washes durability





Art.no. Case TSU	Description	Size in cm	Pieces/pack	Packs/case	Art.no. Pack BCU	Application
175195	Twixter frame	40	1	10	175195	  

## Tronic Light



- ✓ Very good dirt and liquid absorption
- ✓ High durability
- ✓ Good gliding performance
- ✓ Ideal for smooth as well as structured floors, like Rubber, Lino, Vinyl floors
- ✓ For maintenance cleaning in wet and damp mopping processes
- ✓ Up to 300 washes durability



Art.no. Case TSU	Description	Size in cm	Pieces/pack	Packs/case	Art.no. Pack BCU	Application
175247	Tronic Light	40	1	25	175247	  

Wiping

Scouring

Gloves

Floor Cleaning

Brushware

Trolleys

Waste Management

## r-Tronic



All-rounder for a wide range of applications

- ✓ Ideal for heavily soiled areas where strong dirt dissolution and absorption of dirty liquid is required
- ✓ Excellent water absorption combined with good gliding properties
- ✓ Collect easily hair and loose dirt.
- ✓ Mop is made from up to 29% recycled materials
- ✓ High durability – up to 700 washes



Art.no. Case TSU	Description	Size in cm	Pieces/pack	Packs/case	Art.no. Pack BCU	Application
175248	r-Tronic	40	1	25	175248	  

## r-Basic



High Absorber



- ✓ Good water absorption combined with good gliding properties
- ✓ High level of dirt removal
- ✓ High durability
- ✓ For damp and wet cleaning on all hard floors
- ✓ Mop is made from up to 25% recycled materials
- ✓ Up to 300 washes durability

Art.no. Case TSU	Description	Size in cm	Pieces/pack	Packs/case	Art.no. Pack BCU	Application
175216	r-Basic	40	1	25	175216	  

## Flat Press





- ✓ Allows the mop to be easily pressed out at the frame, thanks to its press lever
- ✓ Due to the double-sided mop, it is ideal for cleaning floors in large areas
- ✓ Twixter press for effortless squeezing of the Twixter mop without hand contact
- ✓ At the maximum pressure point (soft point), the mop on the frame is automatically pressed out by the press without exerting pressure on the press lever
- ✓ Additional press support is needed to mount the press on a trolley

Art.no. Case TSU	Description	Size in cm	Pieces/pack	Packs/case	Art.no. Pack BCU	Application
175274	Flat Press	20 x 55 x 56	1	1	175274	  

## Press Support Kit



- ✓ Designed for the Origo 2 trolley system
- ✓ Fits on Origo 2 B platform
- ✓ Perfect for double sided cleaning
- ✓ To be used with Twixter Press (175274) plus 2 x 22 l long buckets (131662)

Art.no. Case TSU	Description	Size in cm	Pieces/pack	Packs/case	Art.no. Pack BCU	Application
168283	Press Support Kit	56 x 48 x 43	1	1	168283	  



## Bucket 22 l



- High quality polypropylene buckets
- Colour coding clips available
- With scale on the inside
- 2 buckets 22 l long can be hooked into each other

Art.no. Case TSU	Description	Size in cm	Pieces/pack	Packs/case	Art.no. Pack BCU	Application
131662	Bucket 22 l long with 8 colour coding clips	-	1	10	131663	

## DesTub Set 35 l



- Dosing unit for use with the Twixter floor cleaning system in the 2-stage wet/dry process
- 16 l maximum fill capacity in use
- With liter scale to see remaining liquids
- Including box 35 l, Dosing Insert 35 l incl. Sieve and Cover for Dosing Insert 35 l

Art.no. Case TSU	Description	Size in cm	Pieces/pack	Packs/case	Art.no. Pack BCU	Application
175380	DesTub Set 35 l	49 x 51	1	1	175380	



## CONTACTLESS MOP DROP

Release the mop safely and hygienically at the push of a button



## UltraSpeed Pro

Ultra Speed Pro is the most up to date, best performing flat mop bucket and press system on the market. It is so easy to use it needs no training and is adaptable to suit all sites. Start with the single bucket system for general floor cleaning or add a second bucket onto the chassis and you have a double bucket system for mopping larger areas. If you want to fulfil more cleaning tasks you can use the second bucket to carry chemicals, cloths, paper etc. Whatever the cleaning requirements, UltraSpeed Pro will dramatically raise your standards in speed, performance/costs, versatility and ergonomics.

### UltraSpeed Pro Single Bucket



- ✓ US Pro Single Bucket System 25l: chassis, 25l bucket, press
- ✓ US Pro Double Bucket System Push: chassis, 25l bucket, 10l bucket, press, push bar

Art.no. Case TSU	Description	Size in cm	Pieces/pack	Packs/case	Art.no. Pack BCU	Application
147180	UltraSpeed Pro Single Bucket System (25 l bucket)	56 × 38 × 86	1	1	147191	
147200	UltraSpeed Pro Double Bucket System Push	59 × 38 × 86	1	1	147209	

### UltraSpeed Pro Ready-to-Go Sets



- ✓ US Pro Single Bucket Ready to Go Kit: chassis, 25l bucket, press, US Pro frame 40cm, mop, telescopic handle 100–180cm
- ✓ US Pro Double Bucket Ready to Go Kit: chassis, 25l bucket, 10l bucket, press, push bar, US Pro frame 40cm, mop, telescopic handle 100–180cm
- ✓ Possible mops are: r-Trio Max Mop, r-MicroSpeed Max Mop, r-Microlite Max Mop

Art.no. Case TSU	Description	Size in cm	Pieces/pack	Packs/case	Art.no. Pack BCU	Application
173914	Ultra Speed Pro Single Bucket Ready to Go Kit (r-MicroSpeed Max Mop)	56 × 38 × 86	1	1	173915	
173904	US Pro Double Bucket Ready to Go Kit Push (r-MicroSpeed Max Mop)	59 × 38 × 86	1	1	173905	
174034	Ultra Speed Pro Double Bucket Ready to Go Kit (r-Trio Max Mop)	56 × 38 × 86	1	1	174035	
173906	Ultra Speed Pro Double Bucket Ready to Go Kit Push (r-Microlite Max Mop)	59 × 38 × 86	1	1	173907	

### UltraSpeed and CombiSpeed Accessories

Art.no. Case TSU	Description	Size in cm	Pieces/pack	Packs/case	Art.no. Pack BCU	Application
146964	UltraSpeed Pro Press	31 × 22.8 × 25.1	1	8	147595	
146963	UltraSpeed Pro Frame	40	1	10	147593	
114001	UltraSpeed Bucket 15l, blue	36.5 × 28 × 27	1	10	508242	
114002	UltraSpeed Bucket 25l, blue	37.2 × 28.3 × 36.5	1	10	508243	
526330	Bucket 10l for the Chassis	30 × 23.4 × 28.2	1	1	526330	
147252	Chassis, 55 × 37 × 6	-	1	6	147956	
147251	Wheels for the Chassis	-	1	12	147597	
147412	UltraSpeed Pro Push Bar Kit	-	1	1	147427	
114003	Clips red, yellow, green for US buckets	-	20	3	114012	
120942	Bucket 6l with 8 colour coding clips	27.8 × 17.6 × 21.6	1	10	120943	
125948	Lid for 6l bucket	27.6 × 17.7 × 2.3	1	12	125949	

## UltraSpeed Pro Frame

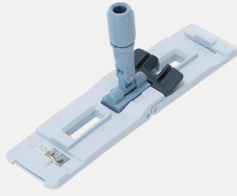

- 40 cm wide flat Mopframe
- For use with all UltraSpeed Pro flat mopping systems
- Large foot pedal – easy to step on
- Mop frame stays open when pressed

Art.no. Case TSU	Description	Size in cm	Pieces/pack	Packs/case	Art.no. Pack BCU	Application
146963	UltraSpeed Pro Frame	40	1	10	147593	
111380	Telescopic Handle, blue	100 – 180	1	10	111385	
506267	Universal Aluminum Handle, blue	150	1	10	506267	
116720	Universal Aluminum Handle Contract		1	10	510400	

## UltraSpeed r-MicroSpeed Max Mop



4D-High Performer for all types of dirt

- Extra dense 4D-cleaning structure for effective cleaning even on structured floors:
  - Premium microfibre based cut pile combined with outer loops
  - Fine microfibre for intensive and deep cleaning
  - Diagonal oriented scrub-zones to loosen sticky dirt
  - Water channels for perfect liquid transport
  - Asymmetric outer loops for reliable particle and hair collection and for deep cleaning in corners and edges
- Mono-material, 100% recyclable
- Up to 99.99% of virus removal (tested with Bovine corona virus on vinyl surfaces at 3<sup>rd</sup> party lab)

Art.no. Case TSU	Description	Size in cm	Pieces/pack	Packs/case	Art.no. Pack BCU	Application
173476	r-MicroSpeed Max	40	1	20	173477	

## UltraSpeed r-MicroLite Max



XL-performance and hygiene specialist

- For general cleaning of sealed or smooth surfaces and specialist on structured vinyl floors
- Highly effective XL mop construction to clean farther:
  - Symmetric cleaning lips for fast and efficient corner and skirting board cleaning
  - Easy gliding microfibre mop with all-over scrubbing islands to loosen sticky dirt
- Mono-material, 100% recyclable
- Up to 99.99% of virus removal (tested with Bovine corona virus on vinyl surfaces at 3<sup>rd</sup> party lab)

Art.no. Case TSU	Description	Size in cm	Pieces/pack	Packs/case	Art.no. Pack BCU	Application
173420	r-MicroLite Max	40	1	20	173421	

## UltraSpeed r-Trio Max



All-rounder with maximized dirt removal

- For use on heavily soiled floors
- Easy gliding loop construction adjusts to any hard floor surface
- Perfected 4-line cleaning zones:
  - Strong scrubbing zones to loosen trapped dirt
  - Microfibre zones for deep cleaning
  - Highly absorbant outer zones for excellent pick up of spills, loose dirt and hairs
  - Low friction center zone for easy mop gliding
- Up to 99.9% of virus removal (tested with Bovine corona virus on vinyl surfaces at 3<sup>rd</sup> party lab)

Art.no. Case TSU	Description	Size in cm	Pieces/pack	Packs/case	Art.no. Pack BCU	Application
173431	r-Trio Max	40	1	20	173432	

Wiping

Scouring

Gloves

Floor Cleaning

Brushware

Trolleys

Waste Management

# CombiSpeed Pro System

The CombiSpeed Pro system includes a wide assortment of pocket and strip Mops for use in a variety of applications. From the high performance of Trio and MicroSpeed Plus to the economy of Contract and MicroLite we have a Mop that meets your requirements in terms of application, performance or budgets. Each Mop type is available in 40 cm and 50 cm sizes in both pocket and pocket/strip attachments and fit all commercially frames. Additional features also include barcode labels and colour coding tags as standard.

With the CombiSpeed Pro cleaning system you choose the Mop that suits your requirements, not the Mop that suits your system.

## Single & Double Bucket System



- Compact single and double Bucketvertical press solution
- Small footprint allows easy storage in the smallest of cleaning cupboards
- No water drips between buckets
- Covers all double Bucketcleaning styles

Art.no. Case TSU	Description	Size in cm	Pieces/pack	Packs/case	Art.no. Pack BCU	Application
149091	Vertical Press Single Bucket Systems 25l	56 x 38 x 86	1	1	149098	
149092	Vertical Press Double System Push 25l + 10l	59 x 38 x 86	1	1	149099	

## CombiSpeed Pro Frame



- Versatile Mopframe available in two sizes (40 cm and 50 cm) that can be used with all pocket and strip Mopsystems
- Innovative patent pending strip clamps allows easy fixation of strip mops
- Durable, lightweight, low profile design reduces stresses on operators shoulders and backs
- Cleaning under tables, radiators etc. simple and ergonomically correct

Art.no. Case TSU	Description	Size in cm	Pieces/pack	Packs/case	Art.no. Pack BCU	Application
143572	CombiSpeed Pro Frame	40	1	10	143573	
143580	CombiSpeed Pro Frame	50	1	10	143581	
111380	Telescopic Handle, blue	100 – 180	1	10	111385	
111529	Universal Aluminum Handle, blue	150	1	10	506267	
116720	Universal Aluminum Handle Contract		1	10	510400	

## r-Trio Max



All-rounder with maximized dirt removal

- For use on heavily soiled floors
- Easy gliding loop construction adjusts to any hard floor surface
- Perfected 4-line cleaning zones:
  - Strong scrubbing zones to loosen trapped dirt
  - Microfibre zones for deep cleaning
  - Highly absorbant outer zones for excellent pick up of spills, loose dirt and hairs
  - Low friction center zone for easy mop gliding
- Up to 99.9% of virus removal (tested with Bovine corona virus on vinyl surfaces at 3<sup>rd</sup> party lab)



Art.no. Case TSU	Description	Size in cm	Pieces/pack	Packs/case	Art.no. Pack BCU	Application
173456	r-Trio Max (Pocket/Strip CC)	40	1	20	173457	
173464	r-Trio Max (Pocket/Strip CC)	50	1	20	173465	

## Tuft Mop



- ✓ Tufted Moppad with high cleaning performance
- ✓ High water- and dirt pick-up
- ✓ Mop pad only with pockets
- ✓ With pockets and colour coding tag

Art.no. Case TSU	Description	Size in cm	Pieces/pack	Packs/case	Art.no. Pack BCU	Application
143192	Tuft Mop (Pocket/Strip CC)	40	1	20	143226	
143193	Tuft Mop (Pocket/Strip CC)	50	1	20	143227	

## r-MicroSpeed Max



4D-High Performer for all types of dirt

- ✓ Extra dense 4D-cleaning structure for effective cleaning even on structured floors:
  - Premium microfibre based cut pile combined with outer loops
  - Fine microfibre for intensive and deep cleaning
  - Diagonal oriented scrub-zones to loosen sticky dirt
  - Water channels for perfect liquid transport
  - Asymmetric outer loops for reliable particle and hair collection and for deep cleaning in corners and edges
- ✓ Mono-material, 100% recyclable
- ✓ Up to 99.99% of virus removal (tested with Bovine corona virus on vinyl surfaces at 3<sup>rd</sup> party lab)

Art.no. Case TSU	Description	Size in cm	Pieces/pack	Packs/case	Art.no. Pack BCU	Application
173470	r-MicroSpeed Max (Pocket)	40	1	20	173471	

## r-Microlite Max



XL-performance and hygiene specialist

- ✓ For general cleaning of sealed or smooth surfaces and specialist on structured vinyl floors
- ✓ Highly effective XL mop construction to clean farther:
  - Symmetric cleaning lips for fast and efficient corner and skirting board cleaning
  - Easy gliding microfibre mop with all-over scrubbing islands to loosen sticky dirt
- ✓ Mono-material, 100% recyclable
- ✓ Up to 99.99% of virus removal (tested with Bovine corona virus on vinyl surfaces at 3<sup>rd</sup> party lab)

Art.no. Case TSU	Description	Size in cm	Pieces/pack	Packs/case	Art.no. Pack BCU	Application
173407	r-Microlite Max (Pocket)	40	1	20	173408	
173414	r-Microlite Max (Pocket)	50	1	20	173415	

## Base Loop Mop



- ✓ Good cleaning performance, absorbancy & durability
- ✓ Smooth, even water release
- ✓ Easy gliding
- ✓ Lowest weight, reduces laundry costs
- ✓ Machine washable over 150 times at 70°C
- ✓ Suitable for Bucketpress cleaning



Art.no. Case TSU	Description	Size in cm	Pieces/pack	Packs/case	Art.no. Pack BCU	Application
151060	Base Loop Mop (Pocket CC)	40	1	100	151069	
151061	Base Loop Mop (Pocket CC)	50	1	100	151070	

Wiping

Scouring

Gloves

Floor Cleaning

Brushware

Trolleys

Waste Management



## Base Micro Mop



- ✓ Cut pile Microfibre cleaning surface
- ✓ Very low weight, reduces laundry costs
- ✓ Machine washable over 150 times at 70°C
- ✓ Suitable for Bucketpress and pre-prepared cleaning

Art.no. Case TSU	Description	Size in cm	Pieces/pack	Packs/case	Art.no. Pack BCU	Application
173357	Base Micro Mop (Pocket CC)	40	1	100	173358	
173363	Base Micro Mop (Pocket CC)	50	1	20	173364	

## CombiSpeed r-MicroTech



- ✓ Microfibre cleaning performance to clean all flooring types
- ✓ \* Up to 99.99% Bovine coronavirus removal from vinyl surfaces tested at a 3<sup>rd</sup> party lab
- ✓ Up to 99.99% bacteria removal tested with P. aeruginosa & S. aureus on vinyl surfaces at a 3<sup>rd</sup> party lab
- ✓ Made from up to 30% post-consumer recycled materials
- ✓ Reduced chemical and water consumption

Art.no. Case TSU	Description	Size in cm	Pieces/pack	Packs/case	Art.no. Pack BCU	Application
169383	CombiSpeed r-MicroTech	40	1	20	169384	

## MicroCombi Mop



- ✓ Combination of the microfibre cut pile material of MicroPlus and the microfibre fringes of MicroTech
- ✓ Excellent cleaning performance on all floor types
- ✓ Nordic swan certified
- ✓ Made from up to 15% recycled materials
- ✓ \* Up to 99.99% Bovine coronavirus removal from vinyl surfaces tested at a 3<sup>rd</sup> party lab

Art.no. Case TSU	Description	Size in cm	Pieces/pack	Packs/case	Art.no. Pack BCU	Application
144267	CombiSpeed MicroCombi Mop (Pocket CC)	40	1	20	525160	

## MicroPlus Mop



- ✓ Highest cleaning performance due to microfibre cut pile construction
- ✓ Especially effective on safety and rubber floors as well as on structured, open-pored floors
- ✓ Cleaning strips for easier removal of dried dirt
- ✓ Low washing costs, reduced use of chemicals
- ✓ Pocket Mopsystem
- ✓ \* Up to 99.99% Bovine coronavirus removal from vinyl surfaces tested at a 3<sup>rd</sup> party lab

Art.no. Case TSU	Description	Size in cm	Pieces/pack	Packs/case	Art.no. Pack BCU	Application
144269	CombiSpeed MicroPlus Mop (Pocket CC)	40	1	20	525162	

## SafeMop



For daily and periodic cleaning of all non slip floors.

- 100 % Polyester: High chemical resistance against Chlorine, bleach etc.
- Scrubs and releases dirt trapped in the floor structure and then picks it up and removes it
- Microfibre: Increases absorbancy and dirt pick up
- Low friction

Art.no. Case TSU	Description	Size in cm	Pieces/pack	Packs/case	Art.no. Pack BCU	Application
147476	SafeMop (Pocket CC)	40	1	20	147484	

## r-MicroOne Premium CombiSpeed Pro

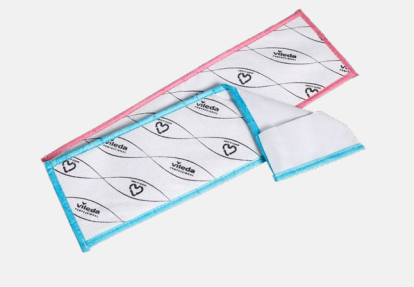

The new sustainable single-use microfibre pocket mop

- Very good cleaning performance due to microfibre technology
- \*Up to 99.99% bovine coronavirus removal from vinyl surfaces as tested at a 3<sup>rd</sup> party lab
- Up to 99.99% bacteria removal (P. aeruginosa & S. aureus on vinyl surfaces at a 3<sup>rd</sup> party lab)
- Made of 88% recycled fibres
- 100% recyclable
- Optimum floor coverage due to an up to 30% extra floor coverage
- Suitable for Pre-prepared and Bucket method

Art.no. Case TSU	Description	Size in cm	Pieces/pack	Packs/case	Art.no. Pack BCU	Application
170306	r-MicroOne Premium CombiSpeed Pro, blue	40	40	6	170307	
170308	r-MicroOne Premium CombiSpeed Pro, red	40	40	6	170309	

## Vertical Mopping Systems

A traditional system in the wet mopping is still the vertical Mopassortment. Vileda Professional offers a range which fits to all needs, from the innovative UltraSpin Mini to a small and flexible system with several Mopmaterials in the SuperMoprange to a traditional Kentucky Mopsystem up to a Twist Mop which could be used without any press.

### UltraSpeed Mini Starter Kit



- Starter Kit contains one bucket and bionic press wringer, one mop frame and one microfibre MicroMop pad

Art.no. Case TSU	Description	Size in cm	Pieces/pack	Packs/case	Art.no. Pack BCU	Application
133414	UltraSpeed Mini Starter Kit	–	1	2	133416	
129619	UltraSpeed Mini Mop Frame	34	1	10	517277	
129618	UltraSpeed Mini Telescopic handle	80–140	1	10	517304	
132558	UltraSpeed Mini MicroLite Mop	34	1	10	517278	

Wiping

Scouring

Gloves

Floor Cleaning

Brushware

Trolleys

Waste Management

## SuperMop AG



- Low friction, lightweight non-woven material
- Independently tested to kill bacteria in direct contact
- Improved cleaning results due to zig-zag edges
- Light metallic handle with "Monoclick" holder
- Bucket & wringer: lightweight Bucket and wringer with integrated handle holder is highly portable and easy to store

Art.no. Case TSU	Description	Size in cm	Pieces/pack	Packs/case	Art.no. Pack BCU	Application
162136	SuperMop Bucket 10l with wringer	-	1	12	162137	
167842	SuperMop AG, blue	-	1	24	167850	
100273	SuperMop handle	138	1	36	100838	

## UltraSpin Mini Starter Kit



- 1 x Bucket & Spin Wringer (blue funnel)
- 1 x Mop Frame (blue)
- 1 x MicroFibre Mop Head (neutral white)
- Kit does not include a handle

Art.no. Case TSU	Description	Size in cm	Pieces/pack	Packs/case	Art.no. Pack BCU	Application
152910	UltraSpin Mini Starter Kit, blue	48.6 x 29.6 x 29.3	1	1	143573	
129618	UltraSpeed Mini Telescopic handle	80 - 140	1	10	517304	

## UltraSpin Mini Microfibre Mop



- 100 % Microfibre
- Neutral white strands with black recycled plastic housing
- Colour coding is on mop frame
- Machine washable >10x

Art.no. Case TSU	Description	Size in cm	Pieces/pack	Packs/case	Art.no. Pack BCU	Application
152901	UltraSpin Mini Microfibre Mop	20 x 20 x 5	1	10	531141	

## UltraSpin Mini Frame



- Replacement Mop Frames
- Available in blue

Art.no. Case TSU	Description	Size in cm	Pieces/pack	Packs/case	Art.no. Pack BCU	Application
152902	UltraSpin Mini Frame, blue	15.7 x 15.9 mm	1	20	531175	

## Kentucky Mop



- Kentucky Mopframe: very strong locking ring to fix the handle self-locking to ensure Mopis safely fixed
- Kentucky Mopfor wet wiping of floors
- Kentucky Cotton mop: Made of cotton fringes, therefore high absorbancy and good water release. Ideal for mopping medium and big areas

Art.no. Case TSU	Description	Pieces/pack	Packs/case	Art.no. Pack BCU	Application
100321	Kentucky Mop frame	5	10	100864	
118083	Kentucky Mop cotton with band	1	50	118084	
111529	Universal Aluminum Handle, blue	1	10	506267	
116720	Universal Aluminum Handle Contract	1	10	510400	



# SprayPro Inox

SprayPro is the professional, ready-to-use floor cleaning system containing all you need for Bucketfree mopping. Just fill the handle with water and you have everything you need to clean hard flooring and staircases in one easy-to-use unit. Designed to work with all Vileda Professional mopping systems it easily adapts to your needs, whatever the cleaning task or on-site conditions.



## SprayPro INOX



- ✔ Compatible with all Vileda Professional floor cleaning systems to meet all cleaning tasks and on-site conditions
- ✔ Easy to use, requires no training
- ✔ Ideal for professional and semi-professional cleaners, wherever speed, ease of use and lack of storage are issue
- ✔ SprayPro handle comes with colour codes stickers and dosing jug

Art.no. Case TSU	Description	Size in cm	Pieces/pack	Packs/case	Art.no. Pack BCU	Application
151514	SprayPro INOX Handle and Dosing Jug	145	1	6	151515	
148721	SprayPro INOX Express Set 40 cm (incl. Express frame and 2 x Express BaseLoop)	155	1	1	152801	



UltraSpeed Pro



Swep



Express Pro



Wiping

Scouring

Gloves

Floor Cleaning

Brushware

Trolleys

Waste Management

# Express (Hook and Loop) Flat Mops

Comprehensive range of hook and loop Mops for use with a variety of systems and methods including pre-prepared, spray and dust control.



## Express Pro Mop Frame



- ✓ Ergonomic trapezoid shape
- ✓ Works with all hook and loop systems
- ✓ Replacement blades for increased hygiene

Art.no. Case TSU	Description	Size in cm	Pieces/pack	Packs/case	Art.no. Pack BCU	Application
151209	Express Pro Mop Frame	40	1	10	151233	
151231	Express Pro Frame	60	1	10	151235	
151238	Express Pro Replacement Blades	40	2	10	151242	
111380	Telescopic Handle, blue	100 – 180	1	10	111385	
111529	Universal Aluminum Handle, blue	150	1	10	506267	
116720	Universal Aluminum Handle Contract		1	10	510400	

## Express Pro r-MicroSpeed Max



4D-High Performer for all types of dirt

- ✓ Extra dense 4D-cleaning structure for effective cleaning even on structured floors:
  - Premium microfibre based cut pile combined with outer loops
  - Fine microfibre for intensive and deep cleaning
  - Diagonal oriented scrub-zones to loosen sticky dirt
  - Water channels for perfect liquid transport
  - Asymmetric outer loops for reliable particle and hair collection and for deep cleaning in corners and edges
- ✓ Mono-material, 100% recyclable
- ✓ Up to 99.99% of virus removal (tested with Bovine corona virus on vinyl surfaces at 3<sup>rd</sup> party lab)



Art.no. Case TSU	Description	Size in cm	Pieces/pack	Packs/case	Art.no. Pack BCU	Application
173478	Express Pro r-MicroSpeed Max	40	1	20	173479	
173481	Express Pro r-MicroSpeed Max	60	1	20	173482	

## Express Pro r-MicroLite Max



XL-performance and hygiene specialist

- ✓ For general cleaning of sealed or smooth surfaces and specialist on structured vinyl floors
- ✓ Highly effective XL mop construction to clean farther:
  - Symmetric cleaning lips for fast and efficient corner and skirting board cleaning
  - Easy gliding microfibre mop with all-over scrubbing islands to loosen sticky dirt
- ✓ Mono-material, 100% recyclable
- ✓ Up to 99.99% of virus removal (tested with Bovine corona virus on vinyl surfaces at 3<sup>rd</sup> party lab)



Art.no. Case TSU	Description	Size in cm	Pieces/pack	Packs/case	Art.no. Pack BCU	Application
173425	Express Pro r-MicroLite Max	40	1	20	173394	
173395	Express Pro r-MicroLite Max	60	1	20	173396	



## Express Pro r-Trio Max



All-rounder with maximized dirt removal

- ✓ For use on heavily soiled floors
- ✓ Easy gliding loop construction adjusts to any hard floor surface
- ✓ Perfected 4-line cleaning zones:
  - Strong scrubbing zones to loosen trapped dirt
  - Microfibre zones for deep cleaning
  - Highly absorbant outer zones for excellent pick up of spills, loose dirt and hairs
  - Low friction center zone for easy mop gliding
- ✓ Up to 99.9% of virus removal (tested with Bovine corona virus on vinyl surfaces at 3<sup>rd</sup> party lab)

Art.no. Case TSU	Description	Size in cm	Pieces/pack	Packs/case	Art.no. Pack BCU	Application
173433	Express Pro r-Trio Max	40	1	20	173434	

Wiping

## Express BaseLoop Mop



- ✓ Good cleaning performance, absorbancy & durability
- ✓ Smooth, even water release
- ✓ Easy gliding
- ✓ Lowest weight, reduces laundry costs
- ✓ Suitable for Bucketpress cleaning



Art.no. Case TSU	Description	Size in cm	Pieces/pack	Packs/case	Art.no. Pack BCU	Application
151062	Express BaseLoop Mop (CC)	40	1	100	151071	

Scouring

Gloves



## ClickSpeed Pre-Prepared System

ClickSpeed is a cost effective pre-prepared damp flat mopping system featuring a unique, patented mop frame that is very easy to handle and use. Simply drop the mop on the floor, slide in the frame and then click-close the magnetic mop holder. ClickSpeed can be used with either microfibre durable mops or with microfibre based single use mops.

Floor Cleaning

Brushware

Trolleys

## ClickSpeed



- ✓ Unique magnetic frame, plus durable mops
- ✓ Lightweight and simple to operate and use
- ✓ Mops without pockets or fixings to trap dirt or bacteria
- ✓ Hands-free mop attaching and removing



Art.no. Case TSU	Description	Size in cm	Pieces/pack	Packs/case	Art.no. Pack BCU	Application
138621	ClickSpeed Frame	40	1	10	138622	
138695	ClickSpeed Microfibre MopCloth	44 x 22	5	10	138696	

Waste Management

# Handles

Fixed length and telescopic handles for use across all Vileda Professional floor cleaning systems.



## Sweep Ergo Handle



Ergonomic Design for Efficient Floor Cleaning

- ✓ Rotating ball-grip and grip stop ensure ergonomic usage
- ✓ 3-Star ErgoCert certified when used with Sweep Pro mops and Sweep r-Frames
- ✓ Compatible with all Sweep mops
- ✓ Plastica Seconda Vita certified due to recycled plastic construction
- ✓ ErgoCert certified for superior ergonomics when used with Sweep Pro mops and Sweep handles

Art.no. Case TSU	Description	Colour	Pieces/pack	Packs/case	Art.no. Pack BCU	Application
171340	Sweep Ergo Handle	Blue	1	10	171342	

## Telescopic Handle



- ✓ Robust aluminum telescopic lightweight design
- ✓ Adjustable length of 100–180 cm or 50–90 cm (short version)
- ✓ Ergonomic rounded soft grip for reducing hand tiredness
- ✓ Ergonomic mid grip for easy handling
- ✓ Anti-slip top grip design
- ✓ Colour coded clips available
- ✓ Universal Vileda Professional Fitting

Art.no. Case TSU	Description	Size in cm	Pieces/pack	Packs/case	Art.no. Pack BCU	Application
111380	Telescopic Handle, blue	100 – 180	1	10	111385	
111384	Telescopic Handle short	50 – 90	1	10	111389	

## Universal Aluminum Handle



- ✓ Robust aluminum lightweight design
- ✓ Ergonomic rounded hand grip
- ✓ Colour coded clips for Universal Aluminum Handle available

Art.no. Case TSU	Description	Size in cm	Pieces/pack	Packs/case	Art.no. Pack BCU	Application
111529	Universal Aluminum Handle, blue	150	1	10	506267	

## Aluminum Broom Handle



- ✓ Robust aluminum lightweight design
- ✓ German screw thread fitting
- ✓ Ergonomic rounded hand grip
- ✓ Colour coded clips for Universal Aluminum Handle available

Art.no. Case TSU	Description	Size in cm	Pieces/pack	Packs/case	Art.no. Pack BCU	Application
111533	Aluminum Broom Handle	150	1	10	506271	

## Aluminum Handle Contract

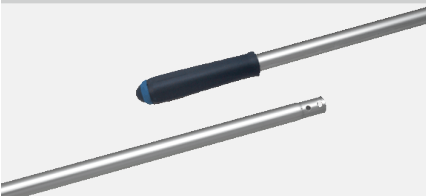

- ✓ The long handle is comfortable to use and easy to clean
- ✓ Rounded grip for nice touch
- ✓ Cost-effective version of Universal Aluminium Handle

Art.no. Case TSU	Description	Size in cm	Pieces/pack	Packs/case	Art.no. Pack BCU	Application
116720	Universal Aluminum Handle Contract		1	10	510400	

## Steel SuperMop Handle



- Unique Monoclick fitting for SuperMop use
- Ergonomic rounded hand grip
- Colour coded clips for Universal Aluminium Handle available

Art.no. Case TSU	Description	Size in cm	Pieces/pack	Packs/case	Art.no. Pack BCU	Application
100273	Steel SuperMop Handle	138	1	36	100838	

## Floor Cloths

Durable and insensible floor cloths with established Vileda Professional quality. Useable with squeegees or scrubbers on all hard floors.

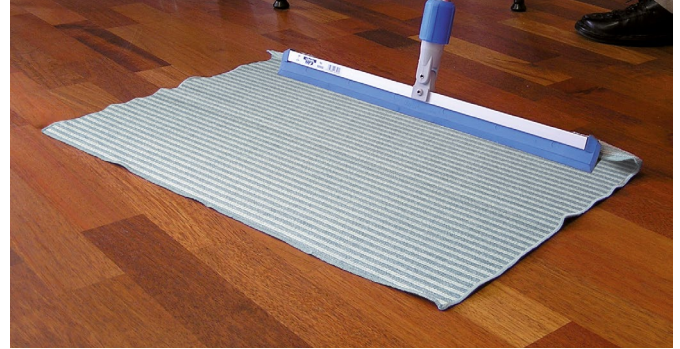

## MultiSqueegee Swivel



For easy, complete removal of dirt and liquids.

- Flexible mono blade easily follows uneven surfaces ensuring easy removal of loose dirt and liquid
- Hard wearing, durable, replaceable blade
- Contoured blade edges protect walls and furniture from damage
- Part of Mop'n Dry System
- Can be used as Mop'n Dry System by adding 2 floorcloth clips (116996)

Art.no. Case TSU	Description	Size in cm	Pieces/pack	Packs/case	Art.no. Pack BCU	Application
114472	MultiSqueegee Swivel	50	1	10	114474	
114468	MultiSqueegee replacement blade, blue	50	1	10	508450	
116996	Floorcloth clips		5	20	116997	
111380	Telescopic Handle, blue	100-180	1	10	111385	
111529	Universal Aluminium Handle, blue	150	1	10	506267	

## Original Floor Cloth



- High quality non-woven material, high absorbancy, high dirt pick-up
- Tearproof, hard-wearing and durable
- Lint-free

Art.no. Case TSU	Description	Size in cm	Pieces/pack	Packs/case	Art.no. Pack BCU	Application
167830	Original Floor Cloth	59 x 50	5	12	167831	

## Vlieser



- Nice bond on scrubber
- Absorbent

Art.no. Case TSU	Description	Size in cm	Pieces/pack	Packs/case	Art.no. Pack BCU	Application
109918	Vlieser size 1	50 x 70	10	10	110038	











## Disposable Dustmopping

The disposable dustmop range comprises a range of viscose and polypropylene non-woven mops that contain a special permanent oil impregnation treatment that retains its effectiveness even after storing for long periods.

### Dustmop Frame Rubber





- Developed for use with all disposable dustmops
- Long-lasting, durable rubber blades ensure maximum surface contact
- Universal connector fits all handles

Art.no. Case TSU	Description	Size in cm	Pieces/pack	Packs/case	Art.no. Pack BCU	Application
122783	Dustmop Frame Rubber	60	1	10	122784	  
111380	Telescopic Handle, blue	100 – 180	1	10	111385	  
111529	Universal Aluminum Handle, blue	150	1	10	506267	  

### ProfiRoll



- Mop cloth pre-impregnated with glue
- Ideal for dry cleaning of hard floor surfaces
- The pre-impregnated surface collects dust like a magnet

Art.no. Case TSU	Description	Size in cm	Pieces/pack	Packs/case	Art.no. Pack BCU	Application
112650	ProfiRoll (50 sheets per roll)	18 × 60	1	6	112388	  

### Dust Cloth High Performance











#### Dustmop High Performance (101)

- For dry cleaning of hospitals, offices and computer rooms
- The pre-impregnated surface collects dust like a magnet
- Reduces the number of airborne particles

#### Dustmop Standard (pink)







- Ideal for dry cleaning of hard floor surfaces
- The pre-impregnated surface collects dust like a magnet
- Easy, quick, high dust capacity

Art.no. Case TSU	Description	Size in cm	Pieces/pack	Packs/case	Art.no. Pack BCU	Application
133909	Dustmop High Performance (101)	60 × 24	50	10	133920	  
133922	Dustmop High Performance (101)	60 × 64	25	10	133923	  
100553	Dustmop Standard, pink	24 × 60	50	20	101028	  

### Mop Cloth



- Durable cloth, economic in use
- Continuous filament, easy to rinse, lint-free
- Ideal for glossy floors

Art.no. Case TSU	Description	Size in cm	Pieces/pack	Packs/case	Art.no. Pack BCU	Application
143121	Mop Cloth	60 × 60	1	100	524790	  
508494	Mop Cloth-Roll 60 m <sup>2</sup>	60 × 100	1	1	508494	  

## Biodegradable dustmop



- 100% bamboo, biodegradable
- No use of chemicals and water required
- Ideal for spot cleaning
- Anti-static
- Ideal for hospitals, nursing homes, offices and computer areas, general building cleaning

Art.no. Case TSU	Description	Size in cm	Pieces/pack	Packs/case	Art.no. Pack BCU	Application
134998	Biodegradable dustmop	60 x 20	1	200	135338	



## Durable Dustmopping

Durable dustmop for fast removal of loose dust and dirt as part of daily maintenance or preliminary cleaning.

When used as part of a maintenance system dustmopping acts as an intermediate cleaning step to reduce the frequency of wet or damp mopping.

Dustmopping can also be used as the preliminary cleaning step of a two step floor cleaning process to remove fine dust particles and solid elements before damp or wet mopping.

## Dustmop Frame Metal

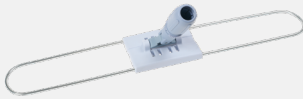

- Break frame for use with Vileda durable dustmops (with pockets)
- Universal connector with Euro-clip

Art.no. Case TSU	Description	Size in cm	Pieces/pack	Packs/case	Art.no. Pack BCU	Application
118085	Dustmop Frame Metal	60	1	12	511274	
111529	Universal Aluminum Handle, blue	150	1	10	506267	

## Durable Yarn Dustmop

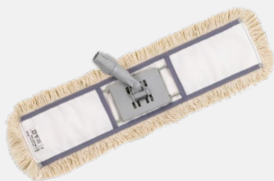

- For use pre-impregnated by the spray method or wrapped in disposable cloths
- Manufactured from absorbent and economical cotton
- Polyester fibre backing and pockets for use with break frames

Art.no. Case TSU	Description	Size in cm	Pieces/pack	Packs/case	Art.no. Pack BCU	Application
118100	Durable Yarn Dustmop	60	1	12	118102	

## Durable Synthetic Dustmop



- Manufactured from acrylic fibers for additional electrostatic attraction
- For use on all floor types
- Ideal for maintenance or spot cleaning processes

Art.no. Case TSU	Description	Size in cm	Pieces/pack	Packs/case	Art.no. Pack BCU	Application
101266	Durable Synthetic Dustmop	60	1	12	500642	

Wiping

Scouring

Gloves

Floor Cleaning

Brushware

Trolleys

Waste Management

# Floorpads





















Superpads are designed to last longer, do the job faster, prolong the life of floor coatings and protect your investment in floorcare machinery. Available in a range of grades and sizes for all motor speeds.

- ✔ Improved machine stability means less stress on machine motors and easier handling for operators
- ✔ Even wear across pad surface without “roll-back” of fibres
- ✔ Abrasive penetrates through the whole thickness of the pad for a longer effective life
- ✔ Floorpads inner diameter 85 mm

## Superpad black























- ✔ Highly abrasive stripping pad
- ✔ For wet stripping and removing of coating and sealing
- ✔ Pad to be used on non-delicate floors
- ✔ Durable by high chemical resistance

Art.no. Case TSU	Description	Size in cm	Pieces/pack	Packs/case	Art.no. Pack BCU	Application
114070	Superpad, black	33	1	5	507964	  
114103	Superpad, black	36	1	5	507965	  
114077	Superpad, black	38	1	5	507966	  
114094	Superpad, black	41	1	5	507967	  
114096	Superpad, black	43	1	5	507968	  
114098	Superpad, black	46	1	5	507969	  
114099	Superpad, black	50	1	5	507970	  

## Superpad green





- ✔ Scrubbing and stripping pad
- ✔ For wet stripping of floor coatings and scrubbing off stubborn dirt
- ✔ Pad to be used on more delicate floors

Art.no. Case TSU	Description	Size in cm	Pieces/pack	Packs/case	Art.no. Pack BCU	Application
114072	Superpad, green	33	1	5	507943	  
114105	Superpad, green	36	1	5	507945	  
114078	Superpad, green	38	1	5	507946	  
114106	Superpad, green	41	1	5	507947	  
114107	Superpad, green	43	1	5	507948	  
115248	Superpad, green	46	1	5	507950	  
114088	Superpad, green	50	1	5	507952	  

## Superpad brown



- ✔ Very abrasive stripping pad
- ✔ For wet and dry stripping and removing of coating and polish
- ✔ Pad to be used on non-delicate floors
- ✔ Durable by high chemical resistance

Art.no. Case TSU	Description	Size in cm	Pieces/pack	Packs/case	Art.no. Pack BCU	Application
114048	Superpad, brown	43	1	5	507901	  



## Superpad blue























- ✓ Pad for spray cleaning
- ✓ Quick removal of marks
- ✓ Wet scrubbing of non-delicate floors
- ✓ Stripping of more delicate floors

Art.no. Case TSU	Description	Size in cm	Pieces/pack	Packs/case	Art.no. Pack BCU	Application
114083	Superpad, blue	43	1	5	508026	  

## Superpad red









- ✓ Universal maintenance pad
- ✓ For mild spray cleaning and dry polishing
- ✓ Builds a fast gloss when spray burnishing

Art.no. Case TSU	Description	Size in cm	Pieces/pack	Packs/case	Art.no. Pack BCU	Application
114073	Superpad, red	33	1	5	508006	  
114104	Superpad, red	36	1	5	508013	  
114079	Superpad, red	38	1	5	508007	  
114095	Superpad, red	41	1	5	508008	  
114097	Superpad, red	43	1	5	508016	  
114108	Superpad, red	46	1	5	508009	  
114100	Superpad, red	50	1	5	508011	  

## Superpad tan











- ✓ Polishing pad
- ✓ For wet cleaning and polishing
- ✓ Pad to be used on delicate floors

Art.no. Case TSU	Description	Size in cm	Pieces/pack	Packs/case	Art.no. Pack BCU	Application
114081	Superpad, tan	41	1	5	507926	  
114084	Superpad, tan	43	1	5	507927	  

## Superpad white



- ✓ Polishing and light cleaning pad
- ✓ Builds up high gloss

Art.no. Case TSU	Description	Size in cm	Pieces/pack	Packs/case	Art.no. Pack BCU	Application
114045	Superpad, white	41	1	5	507981	  
114046	Superpad, white	43	1	5	507982	  
114047	Superpad, white	50	1	5	507985	  

Wiping

Scouring

Gloves

Floor Cleaning

Brushware

Trolleys









Waste Management

# Floorpads for Special Tasks

## Superpad grey









- Perfect for dry or wet top-stripping and for partially taking-off coatings on hard floors
- Pad designed for structured hard floor types and slip resistant surfaces offering a perfectly balanced abrasiveness level
- Highly time and cost saving in dry top-stripping applications
- Also for wet cleaning of hard floors

Art.no. Case TSU	Description	Size in cm	Pieces/pack	Packs/case	Art.no. Pack BCU	Application
114144	Superpad, grey	41	1	5	507895	  
114082	Superpad, grey	43	1	5	507896	  
114145	Superpad, grey	46	1	5	507897	  

## MicroSafety Pad









- Scrubbing pad for use on safety and slip resistant floors, such as structured rubber floors and vinyl-floors or even micro-porous floor-surfaces
- Combination of strong scrubbing fibres and highly absorbent micro fibres offers a deep cleaning effect and strong liquid pick up. Pad collects perfectly released dirt and left over residues trapped in the floor structure
- Tough scrubbing effect and gentle to the surface

Art.no. Case TSU	Description	Size in cm	Pieces/pack	Packs/case	Art.no. Pack BCU	Application
150773	MicroSafety Pad	41	1	5	150776	  
150774	MicroSafety Pad	43	1	5	150777	  

## MicroActive Pad



- Perfect for efficient but gentle cleaning of carpets for maintenance cleaning as well as for interim and spot cleaning. Also applicable for delicate floors such as glazed tiles
- Optimised combination of dense cut-pile microfibre and grey power-brush stripes for a deep cleaning effect
- Highly absorbent pad offering a high m<sup>2</sup>-performance

Art.no. Case TSU	Description	Size in cm	Pieces/pack	Packs/case	Art.no. Pack BCU	Application
118037	MicroActive Pad	41	1	5	512074	  
118038	MicroActive Pad	43	1	5	512075	  

## Care instructions for Vileda Professional floor pads

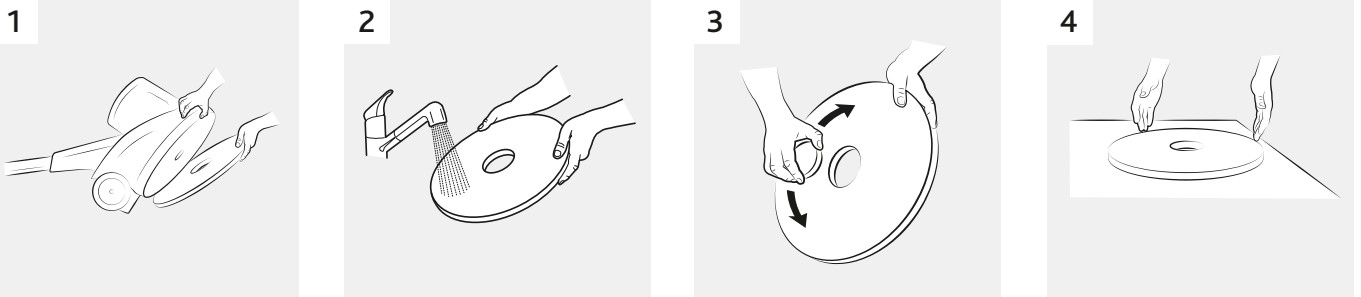

## Floorpads – Compass

Application	Normal runner 150–275 U/min				Fast runner 275–1000 U/min		Ultra High Speed 1000–3000 U/min
	Basic cleaning (only if not coated)	Care film renovation	Wet scrubbing	Care	Spray- Cleanern	Dry polishing	Polishing
<b>Flooring</b>							
PVC	●●●	●	●●●	●●●	●●	●●●	●
Linoleum	●●	●	●●	●●●	●●	●●●	●
Rubber	●●	●	●●●	●●●	●●	●●●	
Polyolefin	●●	●	●●●	●●●	●●	●●●	
PU-Vinyl (structured)			⊗/⊗				
Polished stone, e.g. marble, terrazzo	●		●/⊗	●●●/⊗	●	●●●	●
Rough stone			●●●	●			
Sealed wood				●●●/⊗	●	●●●	
Safety floors			⊗/●/⊗				
Carpet			⊗				

● Black ● Brown ● Green ● Red ● Tan ● Blue ○ White

Special floor pads: ● Grey ● UHS Pad ⊗ MicroActive Pad ⊗ MicroSafety Pad

All floors must be cleaned according to the cleaning instructions of the floor supplier

Wiping

Scouring

Gloves

Floor Cleaning

Brushware

Trolleys

Waste Management



## Edging Tools & Pads

Designed to simplify cleaning, maintenance, restoring and manual spot-cleaning processes. For use in areas inaccessible to machines including corners, walls, floor edges and staircases.

## Padboy & Padmaster















- ✓ Economic cleaning, no bending
- ✓ Makes wall and ceiling cleaning simple
- ✓ Features a locking pin to prevent the handle from turning in use
- ✓ Durable adhesive fixing plate on the bottom of the frame
- ✓ For use with the Aluminum handle

Art.no. Case TSU	Description	Size in cm	Pieces/pack	Packs/case	Art.no. Pack BCU	Application
120544	Padmaster	10.4 × 24.6	1	10	512993	🏠🏢🏠
120542	Padboy	24.6 × 10.4	1	10	512992	🏠🏢🏠
111380	Telescopic Handle, blue	100 – 180	1	10	111385	🏠🏢🏠
111384	Telescopic Handle short	50 – 90	1	10	111389	🏠🏢🏠
111529	Universal Aluminum Handle Contract	150	1	10	506267	🏠🏢🏠

## Handpads Super



- For use with pad holder
- Particularly durable and economical
- White for gentle cleaning
- Green for powerful cleaning and scrubbing
- Grey for the cleaning of safety floor coverings or the renovation of care films
- Black for stripping



Art.no. Case TSU	Description	Size in cm	Pieces/pack	Packs/case	Art.no. Pack BCU	Application
114898	Handpad Super, black	12 x 26	5	5	114909	  
114894	Handpad Super, grey	12 x 26	5	5	114905	  
114897	Handpad Super, green	12 x 26	5	5	114908	  
114900	Handpad Super, white	12 x 26	5	5	114911	  

## Special Handpads

### Handpad MicroActive



- For use with Padboy / Padmaster
- Microfibre pad with power stripes for soft and efficient maintenance cleaning without scratching the surface
- Especially for spot and interim cleaning of carpets
- Also for gentle damp and wet cleaning of delicate stoneware, such as polished tiles

Art.no. Case TSU	Description	Size in cm	Pieces/pack	Packs/case	Art.no. Pack BCU	Application
118039	MicroActive Handpad, white/grey	12 x 26	5	5	119454	  

### MicroSafety Handpad



- Microfibre pad with integrated all-over scrubbing zones for outstanding scrubbing performance
- For intensive wet-scrubbing of structured safety and slip resistant floors, even with micro-porous-surfaces such as un-glazed tiles to take away dirt out of the porous surface
- Especially for maintenance cleaning and initial cleaning

Art.no. Case TSU	Description	Size in cm	Pieces/pack	Packs/case	Art.no. Pack BCU	Application
150772	MicroSafety Handpad, grey	12 x 26	5	5	150775	  





# Brushware

Constructed from easy-to-clean high grade plastic and synthetic filaments, Vileda's hygienic brooms are designed to outlast and outperform ordinary brooms. The Superior brushware range offers best in class hygiene in use. The abrasion resistant bristles consist of Polyester PBT-filaments with excellent bend recovery and sweeping performance as well as a high resistance to a wide range of chemicals, oils, organic solvents and detergents. The strong Polypropylene plastic material withstands heavy use. Its smooth finish helps to prevent soil clinging to the surface. Stainless-steel staples fix the tufts and ensure longlasting rust-free hygiene. The Superior broom- and brushware range is heat resistant and can be autoclaved up to 134 °C for optimal hygiene.

Wiping

Scouring

Gloves

Floor Cleaning

Brushware













Trolleys

Waste Management

## Superior Broom soft/hard



- ✓ Effective floor sweeping with high quality Polyester PBT-filaments. Soft and hard bristles available
- ✓ PBT-bristles offering excellent bend recovery and high resistance against a wide range of chemicals
- ✓ Durable Polypropylene material with easy to clean surface and pin hole
- ✓ Stainless steel staples ensure long-lasting, rust-free hygiene
- ✓ Autoclavable up to 134 °C
- ✓ Universal screw-thread for German and Italian thread. Recommended handle TSU 111533

Art.no. Case TSU	Description	Size in cm	Pieces/pack	Packs/case	Art.no. Pack BCU	Application
145875	Superior Broom soft, PBT Ø 0.25 mm, blue	30	1	6	145876	  
145877	Superior Broom soft, PBT Ø 0.25 mm, blue	50	1	6	145878	  
145879	Superior Broom hard, PBT Ø 0.50 mm, blue	30	1	6	145880	  
145881	Superior Broom hard, PBT Ø 0.50 mm, blue	50	1	6	145882	  

## Eco Broom









Completely made of recycling materials. Housing 100 % PP recycled and fibers from recycled PET.

### Eco broom soft 2-1 fibers

- ✓ Interior usage. Picks up loose small particles, for smooth floors
- ✓ Unsplitted fibers for collecting hair and thinner fibers
- ✓ Splitted fibers for collecting dust and tiny dirt

### Eco broom hard



- ✓ Exterior usage, for rough floors
- ✓ Sweeps carpets, collecting thicker dirt particles from the floor

Art.no. Case TSU	Description	Size in cm	Pieces/pack	Packs/case	Art.no. Pack BCU	Application
131924	Eco Broom soft	30	1	12	517855	  
133785	Eco Broom hard	30	1	12	519227	  

## Superior Deck Scrubber



- ✓ Fast and efficient wet scrubbing of floors and walls
- ✓ Strong PBT-tufts fixed with stainless steel staples in the durable Polypropylene scrubber-body with pin hole
- ✓ Autoclavable up to 134 °C
- ✓ Universal screw-thread for German and Italian thread. Recommended handle TSU 111533

Art.no. Case TSU	Description	Size in cm	Pieces/pack	Packs/case	Art.no. Pack BCU	Application
145883	Superior Deck Scrubber, PBT Ø 0.50 mm, blue	30	1	6	145884	  

## Eco Toilet Set





- Eco toilet set with standard PP-filaments

Art.no. Case TSU	Description	Pieces/pack	Packs/case	Art.no. Pack BCU	Application
100272	Eco Toilet Set white	1	1	100837	  

## Superior Hand Brush





- Short handle general purpose brush
- Strong Polypropylene brush-body combined with abrasion resistant high quality PBT-bristles for efficient and hygienic cleaning
- Stainless steel staples ensure long-lasting, rust-free hygiene
- Autoclavable up to 134 °C
- Closed hook for easy drying and storage

Art.no. Case TSU	Description	Size in cm	Pieces/pack	Packs/case	Art.no. Pack BCU	Application
145873	Superior Hand Brush, PBT Ø 0.50 mm, blue	28	1	12	145874	  

## Superior Dish Brush



- For fast cleaning of dishes before dish-washing
- Efficient and abrasion resistant Polyester PBT-tufts fixed with stainless steel staples for best in class hygiene
- Scraper for easy taking off sticky dirt
- Autoclavable up to 134°C
- Closed hook for easy drying and storage

Art.no. Case TSU	Description	Size in cm	Pieces/pack	Packs/case	Art.no. Pack BCU	Application
145871	Superior Dish Brush, PBT Ø 0.5 mm, blue	26	1	6	145872	  

Wiping

Scouring

Gloves

Floor Cleaning

Brushware

Trolleys

Waste Management

## Floor Wiper

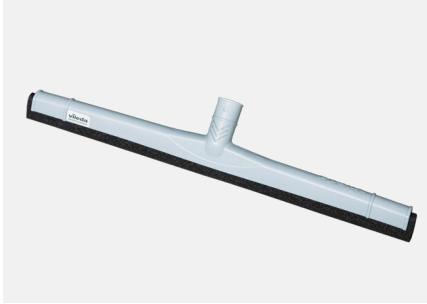

The floor wiper combines modern design with durability and performance. Crafted with high-quality foam, it offers superior water wiping efficiency and long-lasting use.

- ✓ Sleek, contemporary design
- ✓ Excellent water wiping capability
- ✓ Made with durable, premium foam
- ✓ Compatible with Broom Handle (100275)

Art.no. Case TSU	Description	Size in cm	Pieces/pack	Packs/case	Art.no. Pack BCU	Application
179193	Floor Wiper	52	1	12	179193	

## MultiSqueegee Swivel



For easy, complete removal of dirt and liquids.

- ✓ Flexible mono blade easily follows uneven surfaces ensuring easy removal of loose dirt and liquid
- ✓ Hard wearing, durable, replaceable blade
- ✓ Contoured blade edges protect walls and furniture from damage
- ✓ Part of Mop'n Dry System
- ✓ Can be used as Mop'n Dry System by adding 2 floorcloth clips (116996)

Art.no. Case TSU	Description	Size in cm	Pieces/pack	Packs/case	Art.no. Pack BCU	Application
114472	MultiSqueegee Swivel	50	1	10	114474	
114468	MultiSqueegee replacement blade, blue	50	1	10	508450	
116996	Floorcloth clips		5	20	116997	
111380	Telescopic Handle, blue	100 – 180	1	10	111385	
111529	Universal Aluminium Handle, blue	150	1	10	506267	

## Hygiene Foam Squeegee

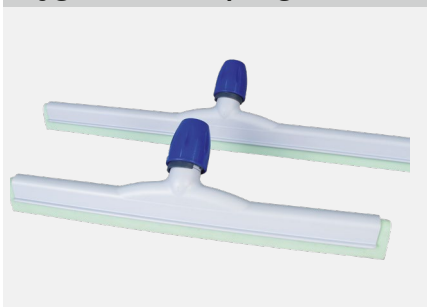

- ✓ For fast removal of liquids
- ✓ High cleaning performance on all surfaces
- ✓ Complies with HACCP recommendations and FDA approved (FDA 21CFR compliant)
- ✓ Colour coded caps (changeable for each work zone, minimising the risk of crosscontamination)
- ✓ Universal handle connector (TSU 111533)

Art.no. Case TSU	Description	Size in cm	Pieces/pack	Packs/case	Art.no. Pack BCU	Application
141972	Hygiene Squeegee	45	1	6	141974	
111380	Telescopic Handle, blue	100 – 180	1	10	111385	
111529	Universal Aluminium Handle, blue	150	1	10	506267	



# Handles

## Aluminum Broom Handle



- ✓ Robust aluminum lightweight design
- ✓ Fixed length of 150 cm
- ✓ Ergonomic rounded hand grip
- ✓ Colour code clips (available on request)
- ✓ German screw thread fitting

Art.no. Case TSU	Description	Size in cm	Pieces/pack	Packs/case	Art.no. Pack BCU	Application
111533	Aluminum Broom Handle	150	1	10	506271	

## Broom Handle

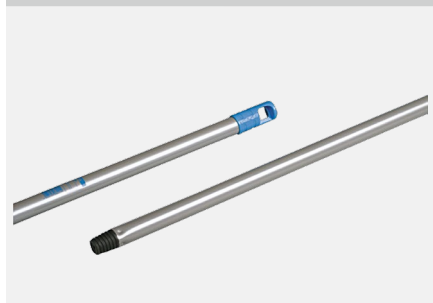

- ✓ Plastic coated steel handle
- ✓ Fixed length of 138 cm
- ✓ Closed Hook at the top for easy storage
- ✓ Italian screw thread fitting

Art.no. Case TSU	Description	Size in cm	Pieces/pack	Packs/case	Art.no. Pack BCU	Application
100275	Broom Handle	138	1	36	100840	



Wiping

Scouring

Gloves

Floor Cleaning

Brushware

Trolleys

Waste Management



## Dustpans

You can choose the most suitable pick up solution for every need. You have the solution at hand.

Every solution is designed to help you achieve the best results as well as offering the highest standards of ergonomics and hygiene. The versatility of the system allows an easy configuration to your needs, as the range is available for several options.

### Hand Brush & Pan Contract



- PET bristles
- Rubber lip
- Ergonomically designed pan handle for better manual grip and storage

Art.no. Case TSU	Description	Size in cm	Pieces/pack	Packs/case	Art.no. Pack BCU	Application
100268	Hand Brush & Pan, blue	30	1	6	100833	

### Closed Lobby Dustpan



The ideal solution on the market for General Building Cleaning and HoReCa.

- System for ergonomic and efficient dirt and dust removal directly into the container
- Hygienic through washable and non-rust material
- Ergonomic hand grip
- Standing up position for convenient storage
- With a trolley hook for easy attachment to workstations
- Light weight

Art.no. Case TSU	Description	Size in cm	Pieces/pack	Packs/case	Art.no. Pack BCU	Application
119912	Closed Lobby Dustpan	29	1	5	512361	

### Open Lobby Dustpan – Metal

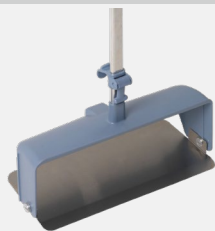

Tailor-made to pick up dirt in the most ergonomic and hygienic way.

- System for ergonomic and efficient dirt and dust removal directly into the bag
- Hygienic through washable and non-rust material
- Ergonomic hand grip
- Adjustable to accommodate different bin bag sizes or washable bin bag
- With a trolley hook for easy attachment to workstations
- Light weight

Art.no. Case TSU	Description	Size in cm	Pieces/pack	Packs/case	Art.no. Pack BCU	Application
119914	Open Lobby Dustpan Metal	30	1	5	512363	

### Lobby Broom and Squeegee



Lobby Broom

- Lobby broom for rough floors with articulated joint made of polypropylene, bristles made of PES Lobby Squeegee
- Lobby Squeegee for smooth floors with articulated joint made of polypropylene
- Clean contraction of coarse and fine dirt without dust formation directly into the waste bag
- Replacement blade which is washable at 90 °C

Art.no. Case TSU	Description	Size in cm	Pieces/pack	Packs/case	Art.no. Pack BCU	Application
119908	Lobby Squeegee	35	1	5	119909	
114465	Lobby Squeegee replacement blade, blue	35	1	10	508445	
119916	Lobby Broom	25	1	5	119918	



# Trolleys

Vileda Professional offers a range of cleaning and hotel trolleys to meet different customer needs and site requirements. Origo 2 sets a new benchmark in cleaning trolleys. It offers improved hygiene, increased efficiency, greater user and site safety and full integration of tablets and digitally assisted cleaning devices. Origo 2 complements the existing VoleoPro and Origo trolley ranges. In addition, the Equipe trolley combines an exclusive look and feel with ease of use thanks to robust materials and smart design. Equipe hotel trolleys are ideal for cleaning hotel rooms, lobbies and conference rooms.

Wiping

Scouring

Gloves

Floor Cleaning

Brushware

Trolleys

Waste Management

# Comodino. Hotel Trolley

## Comodino. Hotel Trolley



The most efficient solution for the transport of cleaning and refill necessities for hotel housekeeping staff.

- ✓ 2x trays
- ✓ 2x 20L storage drawers
- ✓ 4x 100 mm castors with bumper
- ✓ 2x rubber hooks for handles

Art.no. Case TSU	Description	Size in cm	Pieces/pack	Packs/case	Anwendung
173962	Comodino. Hotel Trolley	58 x 40 x 106	1	1	





Wiping

Scouring

Gloves

Floor Cleaning

Brushware

Trolleys

Waste Management

# Trolley Equipe Hotel

## The Trolley for Experienced Hoteliers

Equipe combines an exclusive look and feel with ease of handling thanks to robust materials and a smart design. Equipe Hotel cleaning trolleys are ideal for cleaning hotel rooms, lobbies and conference rooms.

- High Volume:** Thanks to its shelves and height advantage, this cleaning trolley takes loading capacity to the max.
- Designed for Clarity:** The clear layout of storage space plus panelling around the outside creates a neat and tidy impression.
- Perfect Ergonomics:** The height of the push-bar can be adjusted to your comfort level while the smooth-running wheels guarantee easy manoeuvring.
- Individual Branding:** All panelling can be customised to fit in with your corporate design.
- Maximum Modularity:** The modular design concept means you can combine shelves, boxes (5, 15 and 35 litres) and buckets (6 and 8 litres) to suit your individual needs.

# Trolley Equipe Hotel

## Separate disposal



## Clear layout



## Individual configuration and design



# Please get in touch with your sales contact person at Vileda Professional!

They will be pleased to configure a customised Equipe Hotel trolley with you on our configurator.



## Effective storage of small items



## More space with easy add-ons

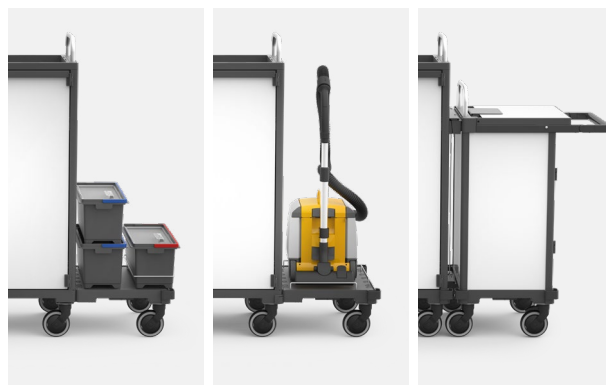

## Easy to manoeuvre even when heavily loaded



Wiping

Scouring

Gloves

Floor Cleaning

Brushware

Trolleys

Waste Management

# Trolley Origo 2



## Security

Innovative design increases safety and peace of mind.



## Efficiency

Intuitive, faster cleaning.



## Sustainability

Taking responsibility for our environment.





# Please get in touch with your sales contact person at Vileda Professional!

They will be pleased to configure a customised Origo 2 trolley with you on our configurator.



## Connectivity

Seamless integration of cleaning tools and digitally connected devices.



## Customisation

Because every space, task and employee is unique.



## Hygiene

Cleaner operational and process management.



Wiping

Scouring

Gloves

Floor Cleaning

Brushware

Trolleys

Waste Management



# OriGO FLEXIBLE



## AX

Our most compact trolley, designed for sites with limited storage after use.

- ✓ Foldable waste section
- ✓ Multi-height push bar
- ✓ Vertical mop Frame holder (fits up to 5 tools/frames)
- ✓ One multi-height inner rail storage section for boxes, trays and surrounds
- ✓ Can be fully enclosed, with lockable doors and push-button top lids
- ✓ Designed for all pre-prepared cleaning systems



## C

Compact and agile, but with room to store all daily cleaning elements.

- ✓ Two multi-height internal rail sections for boxes, trays and surrounds
- ✓ Can be fully enclosed, with lockable doors and push-button top lids
- ✓ Multi-height push bar
- ✓ Vertical mop Frame holder (fits up to 5 tools/frames)
- ✓ Up to 6 buckets fit on top section
- ✓ Designed for pre-prepared cleaning systems



## CX and CXL

The versatile solution, combining generous storage plus fold-down waste.

- ✓ All the benefits of a C but with additional fold down waste section
- ✓ Three separate compartments (e. g. clean, waste and used products)
- ✓ Designed for pre-prepared cleaning systems
- ✓ Can be fully enclosed, with lockable doors and push-button top lids



CONFIGURE YOUR OWN CLEANING TROLLEY AT:  
[WWW.MYORIGO2.COM](http://WWW.MYORIGO2.COM)

Wiping

Scouring

Gloves

Floor Cleaning

Brushware

Trolleys

Waste Management



### C-A

Featuring a handy satellite for transporting products to and from laundry.

- ✓ Three separate compartments (e. g. clean, waste and used products)
- ✓ Foot pedal release on A satellite
- ✓ Three multi-height internal rail sections for boxes, trays and surrounds
- ✓ Vertical mop Frame holders on both sections (fit up to 10 tools/frames)
- ✓ Can be fully enclosed, with lockable doors and push-button top lids
- ✓ Designed for pre-prepared cleaning systems



### C-C

Featuring a bigger satellite for large sites or high volumes of waste.

- ✓ Clear split of functionality (one C for cleaning, one C for used products or waste)
- ✓ Four multi-height internal rail sections for boxes, trays and surrounds
- ✓ Vertical mop Frame holders on both sections (fit up to 10 tools/frames)
- ✓ Can be fully enclosed, with lockable doors and push-button top lids
- ✓ Designed for all pre-prepared cleaning systems or waste removal



### C-B

Storage, waste plus a Bucket & Press satellite for faster mopping results.

- ✓ Two multi-height internal rail sections for boxes, trays and surrounds
- ✓ Can be fully enclosed, with lockable doors and push-button top lids
- ✓ Satellite B section works with all single and double Bucket flat and vertical mops
- ✓ Multi-height push bar on C section and compact push bar on satellite
- ✓ Vertical mop Frame holder (fits up to 5 tools/frames)
- ✓ Can also be used for pre-prepared mop box transportation



### A-B

Compact and versatile Bucket & press satellite for sites with limited storage.

- ✓ All the benefits of the C-B but, with only one multi-height internal rail section
- ✓ Can be fully enclosed, with lockable doors and push-button top lids
- ✓ Satellite B section works with all single and double Bucket flat and vertical mops



## Mop Boxes



- For pre-preparation of all flat mop types
- Easy carry handles
- Colour coding clips available
- For use in inner rail sections and top plate
- Recycled option available (black colour)
- Optional: divider for dosing half a box of mops and lids to protect contents

Art.no. Case TSU	Description	Pieces/pack	Packs/case	Art.no. Pack BCU	Application
-	Origo 2 Mop Box Clip blue	1	-	534421	
-	Origo 2 Lid for Mop & Storage Box	1	-	534422	
-	Origo 2 Recycled Mop Box Clip blue	1	-	534533	
-	Origo 2 Recycled Lid for Mop & Storage Box	1	-	534534	

## Storage Boxes



- Deep storage box
- Easy carry handles
- Colour coding clips available
- For use in inner rail sections and top plate
- Recycled option available (black colour)
- Optional: Lid to protect the content

Art.no. Case TSU	Description	Pieces/pack	Packs/case	Art.no. Pack BCU	Application
-	Origo 2 Storage Box Clip blue	1	-	534426	
-	Origo 2 Lid for Mop & Storage Box	1	-	534422	
-	Origo 2 Recycled Storage Box Clip blue	1	-	534536	
-	Origo 2 Recycled Lid for Mop & Storage Box	1	-	534534	

## Sieve

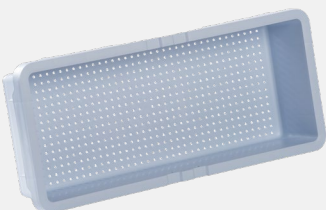

- For easy dosing of mops or cloths in the mop box
- Compatible with mop box and divider

Art.no. Case TSU	Description	Pieces/pack	Packs/case	Art.no. Pack BCU	Application
-	Origo 2 Sieve	1	-	534423	

## Trays



- Equipment storage tray
- For use in inner rail sections and top plate
- Optional Lid to protect content
- Recycled option available (black colour)

Art.no. Case TSU	Description	Pieces/pack	Packs/case	Art.no. Pack BCU	Application
-	Origo 2 Tray	1	-	534424	
-	Origo 2 Lid for Mop & Storage Box	1	-	534422	
-	Origo 2 Recycled Tray	1	-	534535	
-	Origo 2 Recycled Lid for Mop & Storage Box	1	-	534534	

## Divider for Mop Boxes



- Separates mop box into multiple sections
- Allows dosing of half a box of mops

Art.no. Case TSU	Description	Pieces/pack	Packs/case	Art.no. Pack BCU	Application
160582	Origo 2 Divider for Mop Boxes	1	5	160583	



## Small buckets



- ✓ Easy carry handles
- ✓ Colour coding clips available
- ✓ Recycled option available (black colour)
- ✓ Optional: Lid to protect the content

Art.no. Case TSU	Description	Pieces/pack	Packs/case	Art.no. Pack BCU	Application
-	Origo 2 6 l Small Bucket Clip blue	1	-	534428	
-	Origo 2 Lid for Small Bucket	1	-	534429	
-	Origo 2 Recycled 6 l Small Bucket Clip blue	1	-	534537	
-	Origo 2 Recycled Lid for Small Bucket	1	-	534539	

## Large Buckets



- ✓ 15 l and 25 l buckets with specially shaped pouring zone
- ✓ Colour coding clips available
- ✓ Recycled option available (black colour)
- ✓ For direct use with UltraSpeed Pro and vertical press

Art.no. Case TSU	Description	Pieces/pack	Packs/case	Art.no. Pack BCU	Application
114001	15 l Bucket	1	10	508242	
114002	25 l Bucket	1	10	508243	
146964	UltraSpeed Pro Press	1	8	147595	
129023	Vertical Press	1	1	129026	

## Lockable Door Kits



- ✓ Lockable doors prevent unauthorised access
- ✓ Complete kits for enclosing A and C sections

Art.no. Case TSU	Description	Pieces/pack	Packs/case	Art.no. Pack BCU	Application
160556	Origo 2 Door Kit C (4 doors)	1	1	160557	
160558	Origo 2 Door Kit A (2 doors)	1	1	160559	

## Top Lid



- Push button assisted opening for hands free access
- Space for storing cleaning plans

Art.no. Case TSU	Description	Pieces/pack	Packs/case	Art.no. Pack BCU	Application
160815	Origo 2 Top Lid	1	1	160816	
160588	Origo 2 Display for Cleaning Plan	1	10	160589	

## Lockable Top Lid



- Lockable to prevent unauthorised access
- Push button assisted opening for hands free access
- Space for storing cleaning plans

Art.no. Case TSU	Description	Pieces/pack	Packs/case	Art.no. Pack BCU	Application
160550	Origo 2 Lockable Top Lid	1	1	160551	
160588	Origo 2 Display for Cleaning Plan	1	10	160589	

## Lockable Top Lid with Storage Tray



- Lockable to prevent unauthorised access
- Push button assisted opening for hands free access
- Hidden safety compartment for employees' personal items
- Space for storing cleaning plans

Art.no. Case TSU	Description	Pieces/pack	Packs/case	Art.no. Pack BCU	Application
160552	Origo 2 Lockable Top Lid with Storage Tray	1	1	160553	
160590	Origo 2 Display for Cleaning Plan Storage Tray/Tablet	1	10	160591	

## Lockable Top Lid for Tablets

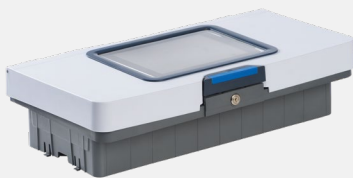

- Secure, fully lockable tablet storage to prevent theft
- See and respond to push notifications directly without opening or lifting the lid
- Compatible with any tablet and workforce management software on the market
- Push button assisted opening
- Hidden safety compartment for employees' personal items

Art.no. Case TSU	Description	Pieces/pack	Packs/case	Art.no. Pack BCU	Application
160554	Origo 2 Lockable Top Lid for Tablets	1	1	160555	
160590	Origo 2 Display for Cleaning Plan Storage Tray /Tablet	1	10	160591	

Wiping

Scouring

Gloves

Floor Cleaning

Brushware

Trolleys

Waste Management

## Adaptor Equipment Holder

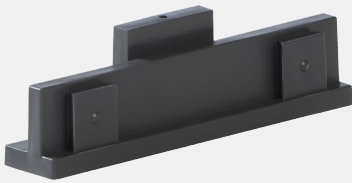

Additional holders to increase storage

Art.no. Case TSU	Description	Pieces/pack	Packs/case	Art.no. Pack BCU	Application
-	Origo 2 Adaptor Equipment Holder Kit	1	-	533853	

## Hooks and Holders

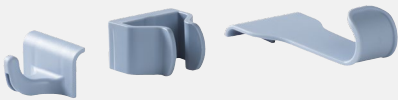

Additional hooks and pins for use with adapter equipment holders and push bars

Art.no. Case TSU	Description	Pieces/pack	Packs/case	Art.no. Pack BCU	Application
160560	Origo 2 Long Hooks	1	10	160562	
160564	Origo 2 Pins	1	10	160565	
160566	Origo 2 Handle Holder	1	10	160567	
161891	Origo 2 Equipment Dustpan Holder	1	10	161892	

## Bag Surrounds



Surround for waste and laundry bags  
Different sizes and widths

Art.no. Case TSU	Description	Pieces/pack	Packs/case	Art.no. Pack BCU	Application
-	Origo 2 Bag Surrounds	1		533785	
-	Origo 2 Bag Surrounds small (vertical)	1		533787	
-	Origo 2 Bag Surrounds small (horizontal)	1		533786	
-	Origo 2 Bag Clamp	1		533789	
122659	Washnet	1	5	514204	

## Waste collection CXL

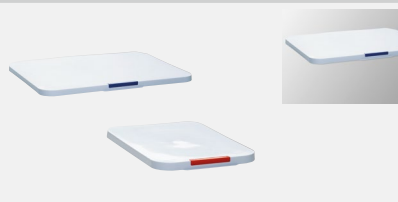

Bin Bag Lid with replaceable clips for colour coding  
Display for cleaning plan  
Bin Bag Surround 70 l and 120 l

Art.no. Case TSU	Description	Pieces/pack	Packs/case	Art.no. Pack BCU	Application
120781	Bin Bag Lid 70 l incl. colour coding clip	1	5	120809	
120782	Bin Bag Lid 120 l incl. colour coding clip	1	5	120810	
120778	Clamping Wire metal	1	10	120820	
120787	Display for cleaning plan	1	10	120818	
126577	Origo Bin Bag Surround 70 l	1	10	515835	
123525	Origo Bin Bag Surround 120 l	1	10	514792	



## Other Accessories

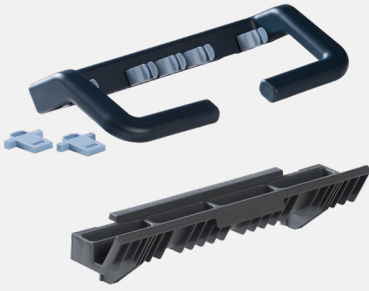

- Additional/replacement push bars
- Additional/replacement mop Frame holder
- Swivel castors with or without brake
- Tray for safe placement of the large buckets

Art.no. Case TSU	Description	Pieces/pack	Packs/case	Art.no. Pack BCU	Application
160599	Origo 2 Push Bar Kit	1	1	160600	
160601	Origo 2 Mop Frame Holder	1	1	160602	
160648	Origo 2 Swivel Castor 125mm	1	1	160649	
160660	Origo 2 Swivel Castor 125mm with brake	1	1	160661	
-	Origo 2 B-Trolley Tray for two buckets (15 l or 25 l)	1	-	533788	
-	Colour clip red	1	-	509264	
-	Colour clip green	1	-	509265	
-	Colour clip yellow	1	-	509266	

## Caution Sign



- The caution sign serves as a warning for wet, freshly cleaned and slippery floors
- It is an indispensable accessory on every cleaning trolley
- The caution sign is foldable and only approx. 4 cm thick when folded up

Art.no. Case TSU	Description	Pieces/pack	Packs/case	Art.no. Pack BCU	Application
174550	Caution Sign	1	6	544712	



Wiping

Scouring

Gloves

Floor Cleaning

Brushware

Trolleys

Waste Management



## Origo Line

Origo means "centre", the centre of your cleaning system for every cleaning task and the carrier of all your cleaning equipment. New contracts, new demands, new methods, new staff. If there is one thing certain about cleaning in the future it's that there will be changes. With this in mind, we created the Origo Line. You can either choose one of our standard configurations or have your trolley customised exactly to your requirements. And when your requirements change – customise it again!

There are 3 steps to choose your perfect solution

### Step 1: Choose your series



#### 300 Series

Plastic base plate. Fully configurable.



#### 500 Series

Durable metal frame. Fully configurable.

### Step 2: Choose your layout



F: Large base with working station



F+X: X = Extension for Bin bag



H: Short base



H+X



H+H+X

### Step 3: Choose your mopping system and accessories



UltraSpeed Pro single and double Bucket press method



Single and double bucket vertical press method



Swep Duo double bucket vertical press method



Pre-Prepared flat mopping method

## Origo 300 FX



- ✓ 2 x Trays
- ✓ 3 x 6l buckets
- ✓ 2 x 25l buckets
- ✓ Vertical press
- ✓ 1 x 120l Bin Bag lid
- ✓ 1 x 120l waste extension or 2 x 70l
- ✓ 2 x Bin Bag Frame metal 70l
- ✓ Castor 12.5 cm
- ✓ 1 x Handle and Frame holder

Config.ID	Description	Size in cm	Pieces/pack	Packs/case	Application
0008087	Origo 300 FX	126 x 58 x 100	1	1	

## Origo 300 HX



- ✓ 2 x Trays
- ✓ 3 x 6l buckets
- ✓ 2 x boxes with lids
- ✓ 1 x 120l Bin Bag lid
- ✓ 1 x 120l waste extension or 2 x 70l
- ✓ 2 x Bin Bag Frame metal 70l
- ✓ 1 x Handle and Frame holder

Config.ID	Description	Size in cm	Pieces/pack	Packs/case	Application
0008091	Origo 300 HX	84 x 58 x 100	1	1	

## Origo 300 HHX



- ✓ 3 x Trays
- ✓ 3 x 6l buckets
- ✓ 4 x boxes with lids
- ✓ 1 x 120l Bin Bag lid
- ✓ 1 x 120l waste extension or 2 x 70l
- ✓ 2 x Bin Bag Frame metal 70l
- ✓ 1 x Handle and Frame holder

Config.ID	Description	Size in cm	Pieces/pack	Packs/case	Application
0008090	Origo 300 HHX	126 x 58 x 100	1	1	



Wiping

Scouring

Gloves

Floor Cleaning

Brushware

Trolleys

Waste Management

## Origo 500 FX



- ✓ 4 x Trays
- ✓ 4 x 6 l buckets
- ✓ 2 x 25 l buckets
- ✓ Vertical press
- ✓ 2 x 70 l Bin Bag lids
- ✓ 1 x 120 l waste extension or 2 x 70 l (foldable)
- ✓ 2 x Bin Bag Frame metal 70 l
- ✓ Castor 12.5 cm
- ✓ 2 x Handle and Frame holder

Config.ID	Description	Size in cm	Pieces/pack	Packs/case	Application
0008088	Origo 500 FX	130 x 58 x 100	1	1	

## Origo 500 HX



- ✓ 2 x Trays
- ✓ 4 x 6 l buckets
- ✓ 4 x boxes with lids
- ✓ 1 x 120 l Bin Bag lid
- ✓ 1 x 120 l waste extension or 2 x 70 l (foldable)
- ✓ 2 x Bin Bag Frame metal 70 l
- ✓ 1 x Handle and Frame holder

Config.ID	Description	Size in cm	Pieces/pack	Packs/case	Application
0008092	Origo 500 HX	88 x 58 x 100	1	1	

## Origo 500 HHX



- ✓ 4 x Trays
- ✓ 4 x 6 l buckets
- ✓ 6 x boxes with lids
- ✓ 1 x 120 l Bin Bag lid
- ✓ 1 x 120 l waste extension or 2 x 70 l (foldable)
- ✓ 2 x Bin Bag Frame metal 70 l
- ✓ 2 x Handle and Frame holder

Config.ID	Description	Size in cm	Pieces/pack	Packs/case	Application
0008093	Origo 500 HHX	130 x 98 x 100	1	1	

## Origo 500 HHX covered



- ✓ 4 x Trays
- ✓ 4 x 6 l buckets
- ✓ 6 x boxes with lids
- ✓ 1 x 120 l Bin Bag lid
- ✓ 1 x 120 l waste extension or 2 x 70 l (foldable)
- ✓ 2 x Bin Bag Frame metal 70 l
- ✓ 2 x Handle and Frame holder
- ✓ 2 x Dividers
- ✓ 2 x Doors
- ✓ Bag Surround

Config.ID	Description	Size in cm	Pieces/pack	Packs/case	Application
0008096	Origo 500 HHX covered	130 x 98 x 100	1	1	

## Other standard configurations and base plates



Art.no. Case TSU	Configuration ID	Description	Size in cm	Pieces/ pack	Packs/ case	Art.no. Pack BCU	Application
01 132710		Origo 300 FX-A-: 2 xTrays, 2 xBucket 6 l, 1 xBucket 15 l, 1 xBucket 25 l, 1 x Vertical Press, 1 x Bin Bag Frame plastic 120 l, 4 x Clamping Wire metal, 1 x Extension, 1 x Support Castor 12.5 cm, 1 x Handle Holder, 1 x Frame Holder, 2 x Hooks	126 x 58 x 100	1	1	132711	
02	0005345	Origo 300 HX: 1 xTray, 2 xBucket 6 l, 1 x Bin Bag Frame plastic 120 l, 4 x Clamping Wire metal, 1 x Extension, 1 x Support Castor 12.5 cm, 1 x Handle Holder, 1 x Frame Holder	84 x 58 x 100	1	1		
03	0008169	Origo 300 HHX: 3 xTrays, 2 x Bucket 6 l, 2 x Mop Box, 2 x Mop Lid, 1 x Bin Bag Frame plastic 120 l, 4 x Clamping Wire metal, 1 x Extension, 1 x Frame Holder, 1 x Handle Holder	126 x 58 x 100	1	1		
04	0014151	Origo 500 HX: 2 xTrays, 2 x Bucket 6 l, 1 x Bin Bag Frame metal 120 l, 4 x Clamping Wire metal, 1 x Extension, 1 x Support Castor 12.5 cm, 1 x Handle Holder, 1 x Frame Holder, 2 x Hooks, 3 x Clip Connector screwable, 4 x Bumper	88 x 58 x 100	1	1		
05	0006876	Origo 500 HHX: 5 xTrays, 2 x Bucket 6 l, 2 x Rail Set, 2 x Mop Box, 2 x Mop Box Lid, 1 x Bin Bag Frame metal 120 l, 4 x Clamping Wire metal, 1 x Extension, 1 x Support Castor 12.5 cm, 1 x Handle Holder, 2 x Hooks, 2 x Clip Connector screwable, 4 x Bumper	130 x 58 x 100	1	1		
06	121572	Origo 300 F – Base plate	91 x 85 x 100	1	1	121573	
07	121574	Origo 300 H – Base plate	54 x 58 x 100	1	1	121575	
08	121602	Origo 300 HH – Base plate	91 x 58 x 100	1	1	121603	
09	126116	Origo 500 F – Base plate	95 x 58 x 100	1	1	126117	
10	121618	Origo 500 H – Base plate	54 x 58 x 100	1	1	121619	
11	126114	Origo 500 HH – Base plate	95 x 58 x 100	1	1	126115	

Wiping

Scouring

Gloves

Floor Cleaning

Brushware

Trolleys

Waste Management

## Buckets



- ✓ High quality polypropylene buckets
- ✓ 6 l Bucket to place on the top of the Origo Trolley
- ✓ Colour coding clips available
- ✓ With scale on the inside
- ✓ 2 buckets 22 l long can be hooked into each other

Art.no. Case TSU	Description	Size in cm	Pieces/pack	Packs/case	Art.no. Pack BCU	Application
120942	Bucket 6 l with 8 colour coding clips	-	1	10	120943	
114001	Bucket 15 l	36.5 x 28 x 27	1	10	508242	
114002	Bucket 25 l	37.2 x 28.3 x 36.5	1	10	508243	
131662	Bucket 22 l long with 8 colour coding clips	-	1	10	131663	
125948	Bucket 6 l lid	-	1	12	125949	

## Wringer and Presses



- ✓ Press holder to add to a Origo trolley to fix Swep Duo press or vertical press
- ✓ Flat press to use with the Swep-Duo mop
- ✓ UltraSpeed press for use with VoleoPro
- ✓ UltraSpeed Pro press for use with UltraSpeed mops
- ✓ Vertical press to use with all other flat and vertical mops

Art.no. Case TSU	Description	Size in cm	Pieces/pack	Packs/case	Art.no. Pack BCU	Application
129023	Vertikal Press	-	1	1	129026	
168207	Swep Duo Press	-	1	1	168208	
121841	Press holder	-	1	1	121842	
113972	US Pro Press	-	1	10	147595	

## Trays



- ✓ Half tray to store 15 l or 25 l or two 6 l buckets or to use as storage place at one side of the trolley
- ✓ Big tray to store two 15 l or two 25 l or four 6 l buckets or to use as storage place at the trolley
- ✓ Outer rail set (uncovered) to add trays or Pre-boxes to trolleys without covering
- ✓ Outer rail set (covered) to add trays or Pre-boxes to trolley with covering
- ✓ Inner railset to add trays or Pre-boxes on the same level in both compartments (only HH versions)

Art.no. Case TSU	Description	Size in cm	Pieces/pack	Packs/case	Art.no. Pack BCU	Application
120784	Tray	-	1	5	120814	
120783	Half Tray	-	1	5	120813	
122572	Outer Rail Set (uncovered): 2 x Rail, 2 x Rail Cover, 4 x Shift protection for rail	-	1	12	122573	
133539	Outer Rail Set (covered): 2 x Rail, 2 x Cover for spacer, 4 x Shift protection for rail	-	1	12	133540	
132682	Inner railset: 2 x Rail, 1 x Spacer for rail, 2 x Shift protection	-	1	12	132683	

## Mop/Cloth Preparation



- Pre-box to prepare mops or cloths incl. colour coding clips (Lid available to order separately)
- Sieve for easy preparation of mops/cloths in the pre-box

Art.no. Case TSU	Description	Size in cm	Pieces/pack	Packs/case	Art.no. Pack BCU	Application
120774	Pre-box	-	1	5	120806	
120780	Lid for Pre-box	-	1	5	120822	
120779	Sieve	-	1	3	120821	

## Waste/Laundry Collection

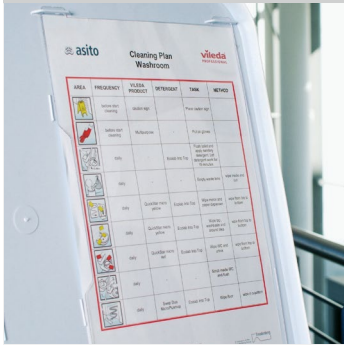

- Bin Bag holder metal 70l fits inside Origo 300 and 500
- Bin Bag holder metal 120l (1 x 120l, 2 x 70l, 2 x 40l and 1 x 60l)
- If required with hooks and lids
- Bin Bag Lid made of resistant plastic
- Display to fix a cleaning plan inside of the lid
- Support castor to stabilize the extension in case of heavy bag
- Replaceable clips for colour coding
- Bin Bag surround to store the Bin or laundry bag, hygienic due to the washable polyester fabric
- Washnet with toggle set for dropping laundry
- Individual printing on request
- Bin Bag clamp metal to fix Bin or laundry bags easily



Art.no. Case TSU	Description	Size in cm	Pieces/pack	Packs/case	Art.no. Pack BCU	Application
122558	Origo 300/500 Bin Bag Frame metal 70 l (Set with 2 multi-connectors)	-	1	7	122559	
122556	Origo 300/500 Bin Bag Frame metal 120 l	-	1	5	122557	
122570	Bin Bag holder plastic	-	1	3	122571	
120778	Clamping wire metal	-	1	10	120820	
120781	Bin Bag Lid 70 l with 4 colour clips	-	1	5	120809	
120782	Bin Bag Lid 120 l with 4 colour clips	-	1	5	120810	
120787	Display for cleaning plan	-	1	10	120818	
122554	Origo 300 Extension (Garbage Bag storage)	-	1	6	122555	
122538	Origo 500 Extension (Set with 2 multi-connectors)	-	1	4	122552	
122578	Support castor 12.5 cm (Swivel castor with fixation)	-	1	7	122579	
126577	Bin Bag surround 70 l	-	1	10	515835	
123525	Bin Bag surround 120 l	-	1	10	514792	
122659	Washnet 70 l	-	1	40	514204	

Wiping

Scouring

Gloves

Floor Cleaning

Brushware

Trolleys

Waste Management

## Accessories



- Mop holder made of resistant plastic. For simple clicking on the plastic platform (Origo 100/300) or various mounting options (patented) on the metal Frame (Origo 500).
- Handle holder to fix the Handle on the trolley
- Hook to store small cleaning utensils
- Caution sign "Achtung Rutschgefahr" to protect wet surfaces and prevent accidents

Art.no. Case TSU	Description	Size in cm	Pieces/pack	Packs/case	Art.no. Pack BCU	Application
120786	Origo 100/300 Mop holder	-	1	5	120816	
120785	Origo 500 Mop holder (Set with 2 clip connectors)	-	1	5	120815	
120772	Handle Holder (Set with 1 clip connector)	-	1	16	120812	
120771	Hook	-	1	50	120811	
111512	Caution sign "Achtung Rutschgefahr"	-	1	20	506254	

## Origo Coverings



- Covering elements to secure and protect the trolley and equipment
- Lockable doors
- Easy to clean
- Individual printing on request

Art.no. Case TSU	Description	Size in cm	Pieces/pack	Packs/case	Art.no. Pack BCU	Application
127477	Origo 300, door kit	-	1	1	516338	
127479	Origo 300, side wall kit short	-	1	1	516337	
127480	Origo 300, side wall kit long	-	1	1	516336	
127481	Origo 300, rear wall kit	-	1	1	516335	
127483	Origo 500, door kit	-	1	1	516334	
127482	Origo 500, side wall kit short	-	1	1	516333	
127750	Origo 500, side wall kit long	-	1	1	516464	
127478	Origo 500, rear wall kit	-	1	1	516332	
127794	Cover for spacer	-	50	50	513219	

## Covering for Origo 300 series

	1 compartment H, HH or FX type						2 compartments HH type					
	1 door	2 doors	3 sides	2 sides	backside	FX/HH trolley	2 doors	3 doors	4 doors	3 sides	2 sides	backside
Door kit	1	2					2	3	4			
Side wall kit short	1	1	1	1		1						
Side wall kit long						1	1	1	1	1		
Rear wall kit	1		1		1		2	1		2		2



## Covering for Origo 500 series

	1 compartment H, HH or FX type						2 compartments HH type					
	1 door	2 doors	3 sides	2 sides	backside	FX/HH trolley	2 doors	3 doors	4 doors	3 sides	2 sides	backside
Door kit	1	2					2	3	4			
Side wall kit short	1	1	1	1			1	1	1	1	1	
Side wall kit long						1						
Rear wall kit	1		1		1		2	1		2		2

Wall/Door

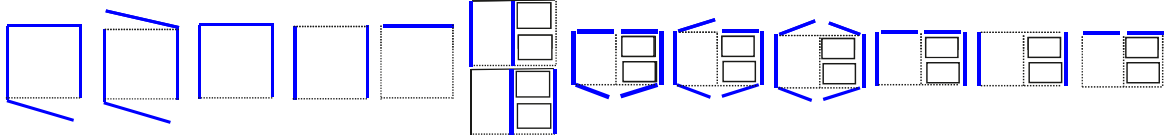

## VoleoPro

With a footprint of 0.5 m<sup>2</sup> VoleoPro is the compact, ideal solution when space is tight. Its unique design and numerous intelligent functions make VoleoPro the business card for professional cleaning performance and cleaning efficiency.

### VoleoPro



- ✓ Compact trolley with a footprint of 0.5 m<sup>2</sup>
- ✓ Easy to manoeuvre and to store where space is limited
- ✓ Quick and easy to assemble

#### VoleoPro Standard includes:

- ✓ Foldaway Bin Bag Lid incl. integrated cleaning plan holder
- ✓ 2 x Bin Bag clamps made out of zinc plated steel wire for fixing a 70 liter Bin Bag
- ✓ Standard set of hooks (includes 5x Pin Hook – 3x Handle Holder – 2x Caution Sign Hook)
- ✓ Ergonomic inclined push unit
- ✓ Integrated tray for carrying items like small buckets on the top of the trolley
- ✓ 2 x 6 liter buckets with Colour coding clips
- ✓ 1 x Multifunctional bridge
- ✓ 1 x Swivel front castor with brake and roller bearing

Art.no. Case TSU	Description	Size in cm	Pieces/pack	Packs/case	Art.no. Pack BCU	Application
143724	VoleoPro Standard	92 x 51.5 x 112.5	1	1	143725	🏠 🚪 🗑️
145233	VoleoPro StarterKit Mopbox and Lid (3 x Mopbox, 3 x Lids for Mopbox)	-	1	5	145234	🏠 🚪 🗑️
145235	VoleoPro StarterKit Bucket and Press (1 x Bucket 25l, 1 x Bucket 15l, 1 x Vertical Press)	-	1	1	145236	🏠 🚪 🗑️
143730	VoleoPro Bin Bag Textile Cover 70l	35.5 x 30 x 50	1	5	143731	🏠 🚪 🗑️
143984	VoleoPro Multifunctional Bridge	42.5 x 23.5 x 19	1	1	143985	🏠 🚪 🗑️
144005	Voleo Pro Swivel Castor with Brake	17 x 6.7x 13.4	1	4	144006	🏠 🚪 🗑️
120942	Bucket 6 l (+ colour coding clips)	27.8 x 17.6 x 21.6	1	10	120943	🏠 🚪 🗑️
125948	Lid for 6 l Bucket	27.6 x 17.7 x 2.3	1	12	125949	🏠 🚪 🗑️

### VoleoPro configuration examples



# Shopster

Unlimited in every detail. Get all the functions of a professional cleaning trolley on the footprint of a double bucket system.

## Shopster



### Fully a trolley. Half the size.

- ✓ Compact 70 cm x 40 cm footprint for space-efficient design
- ✓ Enhanced efficiency with improved maneuverability and convenient access to all essential tools and items
- ✓ Ideal for cleaning small areas (up to 1,000 sqm), narrow corridors, areas such as small offices, gastronomy, retail stores, small branches (e.g. bank, post offices), sanitary facilities or in the conventional cleaning of smaller premises

Art.no. Case TSU	Description	Size in cm	Pieces/pack	Packs/case	Application
178371	Shopster Basic Trolley, 100 mm, with Push Bars, with Cupboard Cabinet	-	1	1	🏠 🍽️ 🧼
178372	Shopster Basic Trolley, 100 mm, with height-adjustable Driving, with Cupboard Cabinet	-	1	1	🏠 🍽️ 🧼
178373	Shopster Basic Trolley Stairs, with height-adjustable Driving, with Cupboard Cabinet	-	1	1	🏠 🍽️ 🧼
178378	Shopster Accessory Pack: Advanced Pre-Prep 10 l	-	1	1	🏠 🍽️ 🧼
178556	Shopster Accessory Pack: Advanced US Pro Press	-	1	1	🏠 🍽️ 🧼

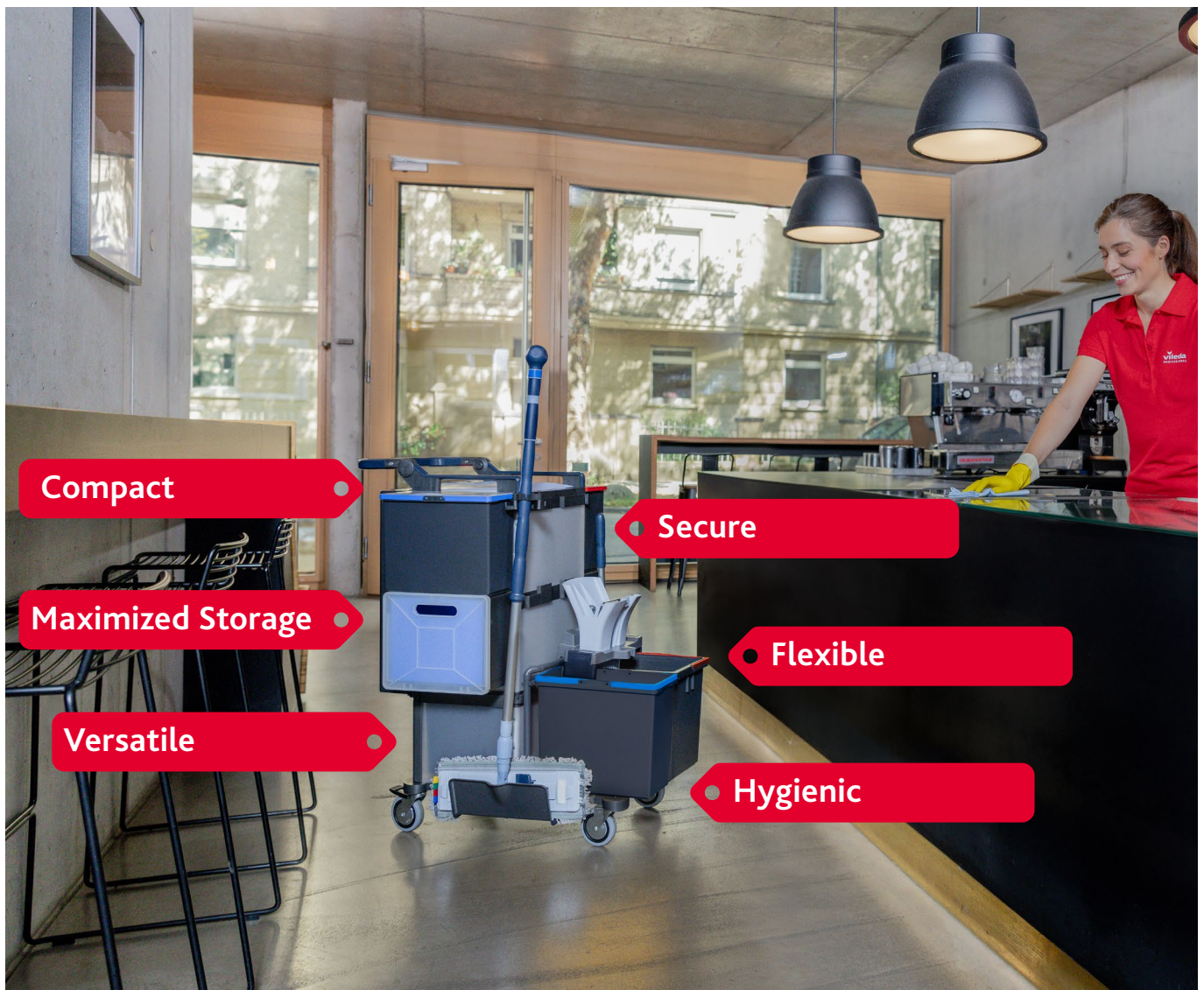

Compact

Secure

Maximized Storage

Flexible

Versatile

Hygienic



# Waste Management

Vileda Professional recognizes the importance of a clean and inviting environment for your customers. Our comprehensive solutions, from advanced cleaning systems to innovative waste management products, ensure your premises remain attractive and competitive.

We offer a range of products designed for efficient waste separation and recycling, including cutting-edge recycling bins with “material layer technology”, HACCP-compliant pedal bins and durable multi-purpose bins. Manufactured in Switzerland under ISO 9001 standards, our Geo, Iris, and Hera bins guarantee high quality and durability.

Wiping

Scouring

Gloves

Floor Cleaning

Brushware

Trolleys

Waste Management

## Geo Metallic – waste separation and recycling



reddot design award  
winner 2012

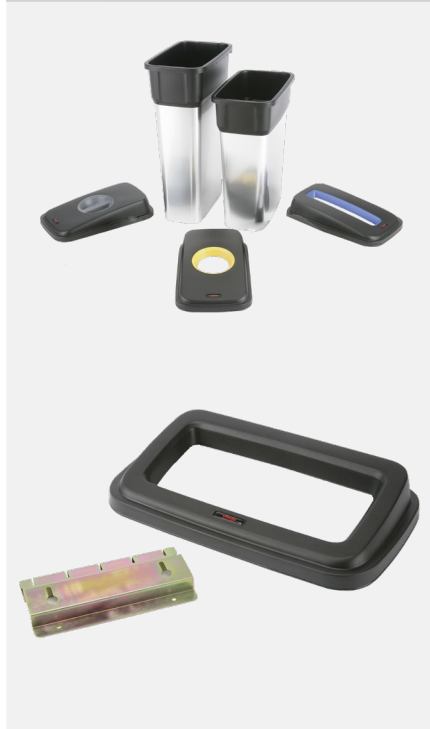

The innovative and durable Geo bin range is the centre of your waste collection and recycling separation system.

- ✓ Durable plastic construction with metallic finish
- ✓ Compact slim line design – fits into the tightest spaces
- ✓ Rust, dent and fingerprint proof
- ✓ Easy to clean and washable
- ✓ Integrated handle – for easy carrying and lifting
- ✓ Integrated bag holder – ensures the correct fit of your waste bag
- ✓ Anti-slip rubber feet – avoids movement in use and protects flooring
- ✓ 2 sizes – 55l and 70l
- ✓ 3 lid options – handle, paper, cans with colour coding or open lid with wall mounting tool
- ✓ Corresponds to combustion class K1 or F1. Tested according to DIN 53438-1:1984-06

### Optional wall mounting kit:

- ✓ Ideal for use in washrooms and areas where cleaning under the bin is required
- ✓ Secure, snug fit against walls
- ✓ Bin can be removed for cleaning and emptying if required

Art.no. Case TSU	Description	Size in cm	Pieces/pack	Packs/case	Art.no. Pack BCU	Application
137660	Geo – 55l Metallic Bin, metallic/black	29 x 49 x 61	1	4	137728	
137661	Geo – 70l Metallic Bin, metallic/black	29 x 49 x 73	1	4	137729	
137662	Geo Handle Lid, black/grey	29 x 49 x 9	1	4	137730	
137663	Geo Paper Lid, black/blue	29 x 49 x 9	1	4	137731	
137665	Geo Cans Lid, black/yellow	29 x 49 x 9	1	4	137733	
138490	Geo – Wall Mounted lid + Bracket, black	29 x 49 x 9	1	4	138496	

## Iris Metallic Round or Square – indoor waste collection



The Iris bin range is designed for indoor use within heavy traffic areas.

- ✓ Durable plastic construction with metallic look
- ✓ Rust, dent and fingerprint proof
- ✓ Washable and easy to clean
- ✓ Integrated handle – for easy carrying and lifting
- ✓ Integrated bag holder – ensures the correct fit of your waste bag
- ✓ Anti-slip rubber feet – avoids movement in use and protects flooring
- ✓ 100% recyclable
- ✓ 50 l round and 60 l square

### Lid options:

- ✓ Hands free funnel
- ✓ Swing lid

Art.no. Case TSU	Description	Size in cm	Pieces/pack	Packs/case	Art.no. Pack BCU	Application
137667	Iris Round – Metallic Bin	38 x 73	1	4	137735	
137668	Iris Round – Funnel Lid, black	38 x 15	1	4	137736	
137673	Iris Square – Metallic Bin	39 x 39 x 73	1	4	137741	
137674	Iris Square – Funnel Lid, black	39 x 39 x 15	1	4	137742	
137676	Iris Square – Swing Lid, black	39 x 39 x 15	1	4	137744	

## Hera – HACCP complying pedal bins



The Hera range of pedal bins comply with HACCP recommendations for hands free operation, making them ideal for use in a variety of applications – from healthcare patient rooms through to food preparation areas where it is crucial to avoid cross contamination.

- ✓ Slow closing lid – ideal for quiet environments
- ✓ Hands Free Operation – complies with HACCP recommendations
- ✓ Large pedal – ideal for use with safety shoes in professional environments
- ✓ Overlapping lid design – keeps odours inside
- ✓ Integrated bag holder – ensures the correct fit of your waste bag
- ✓ Smooth design – easy to clean
- ✓ Anti-slip rubber bumpers – avoids movement in use and protects flooring
- ✓ 3 sizes – 35 l, 60 l and 85 l
- ✓ 4 colours – Blue, Yellow, Black and White
- ✓ Self-extinguishing properties certified by TÜV Rheinland

Art.no. Case TSU	Description	Size in cm	Pieces/pack	Packs/case	Art.no. Pack BCU	Application
137679	Hera – 35 l Pedal Bin, blue	39 x 39 x 44	1	1	137747	
137680	Hera – 35 l Pedal Bin, yellow	39 x 39 x 44	1	1	137748	
137681	Hera – 35 l Pedal Bin, black	39 x 39 x 44	1	1	137749	
137683	Hera – 35 l Pedal Bin, white	39 x 39 x 44	1	1	137751	
137685	Hera – 60 l Pedal Bin, blue	39 x 39 x 69	1	1	137753	
137686	Hera – 60 l Pedal Bin, yellow	39 x 39 x 69	1	1	137754	
137687	Hera – 60 l Pedal Bin, black	39 x 39 x 69	1	1	137755	
137689	Hera – 60 l Pedal Bin, white	39 x 39 x 69	1	1	137757	
137691	Hera – 85 l Pedal Bin, blue	39 x 39 x 79	1	1	137759	
137692	Hera – 85 l Pedal Bin, yellow	39 x 39 x 79	1	1	137760	
137693	Hera – 85 l Pedal Bin, black	39 x 39 x 79	1	1	137761	
137695	Hera – 85 l Pedal Bin, white	39 x 39 x 79	1	1	137763	



# Products

Abrasive Roll	21	Handpads & Handpads Standard Light	21
Accessories	88	Handpads Super	60
Adaptor Equipment Holder	80	HeavyWeight	27
Aluminum Broom Handle	52, 65	Hera – HACCP complying pedal bins	93
Aluminium Contract Handle	52	Hooks and Holders	80
Bag Surrounds	80	Hygiene Foam Squeegee	64
Base Loop Mop	45	Inox Metallic Scourer	22
Base Micro Mop	46	Interior Cleaning Set	17
Biodegradable dustmop	55	Iris Metallic Round or Square	92
Breazy	16	Kentucky Mop	48
Broom Handle	65	Large Buckets	78
Brush Progressive	39	LightWeight	26
Bucket 22 l	41	LiteTuff – Disposable glove	25
Buckets	86	Lobby Broom and Squeegee	66
Caution Sign	81	Lockable Door Kits	78
ClickSpeed	51	Lockable Top Lid	79
Closed Lobby Dustpan	66	Lockable Top Lid for Tablets	79
CombiSpeed Pro Frame	44	Lockable Top Lid with Storage Tray	79
CombiSpeed r-MicroTech	46	MicroActive Pad	58
Comodino Hotel Trolley	68	MicroCombi Mop	46
Contract	26	MicroControl Mop	38
Covering for Origo 300 series	88	Microfibre TeaTowel	13
Covering for Origo 500 series	89	MicronClean Plus	11
DesTub Set 35 l	41	MicroOne	14
Divider for Mop Boxes	77	MicroPlus Mop	46
Durable Synthetic Dustmop	55	MicroRoll	15
Durable Yarn Dustmop	55	MicroSafety Handpad	60
Dust Cloth High Performance	54	MicroSafety Pad	58
Dustmop Frame Metal	55	MicroSorb and MicroSorb Light	11
Dustmop Frame Rubber	54	MicroTuff Base	12
Eco Broom	62	MicroTuff Easy	16
Eco Toilet Set	63	MicroTuff Universal	11
Equipe Hotel	69	MicroWindow	13
Evolution bucket	18	Miraclean (Stain Eraser)	22
Evolution Safety Scraper	18	Mop Boxes	76
Evolution Telescopic Handle	18	Mop Cloth	54
Evolution Washer	18	Mop/Cloth Preparation	87
Evolution Window Wiper	18	MultiDuster	17
Express BaseLoop Mop	51	MultiDuster Maxi r-MicroPlus Pro Sleeve	17
Express Pro Mop Frame	50	MultiPurpose	27
Express Pro r-MicroLite Max	50	MultiSqueegee Swivel	53, 64
Express Pro r-MicroSpeed Max	50	Open Lobby Dustpan – Metal	66
Express Pro r-Trio Max	51	Original Floor Cloth	53
Flat Press	40	Origo 2	72
Floor Wiper	64	Origo 300 FX	83
Geo Metallic	92	Origo 300 HHX	83
GP Plus Cloth	16	Origo 300 HX	83
Hand Brush & Pan Contract	66	Origo 500 FX	84
Handpad MicroActive	60	Origo 500 HHX	84

Origo 500 HHX covered	84	Superpad tan	57	Wiping
Origo 500 HX	84	Superpad white	57	
Origo Coverings	88	Swep Duo HygienePlus Pro	37	Wiping
OriGO Flexible	74	Swep Duo r-MicroCombi Pro	36	
Origo Line	82	Swep Duo r-MicroPlus Pro	36	Wiping
Other Accessories	81	Swep Duo r-MicroTech	36	
Other standard configurations and base plates	85	Swep Duo r-SafetyPlus Mop	36	Wiping
Padboy & Padmaster	59	Swep Ergo Handle	35, 52	
PowerInox	22	Swep r-Frame	35	Scouring
Press Support Kit	40	Swep Single HygienePlus Pro	38	
ProfiRoll	54	Swep Single Micromop	38	Scouring
PurActive	21	Swep Single r-MicroCombi Pro	37	
PURmicro Active	14	Swep Single r-MicroPlus Pro	38	Scouring
PVAmicro	14	Swep Single r-MicroTech	37	
PVA Perfo	15	Swep Wall and Interior Mop	37	Scouring
Quick 'n Dry	15	Telescopic Handle	52	
r-Basic	40	Top Lid	79	Gloves
r-Microlite Max	45	Trays	77, 86	
r-MicronGlass	13	Tronic Light	39	Gloves
r-MicronQuick	10	Tuft Mop	45	
r-MicroOne Premium CombiSpeed Pro	47	Twixter Frame	39	Gloves
r-MicroSpeed Max	45	UltraSpeed and CombiSpeed Accessories	42	
r-MicroTuff Plus	11	UltraSpeed r-Microlite Max	43	Floor Cleaning
r-MicroTuff Swift	12	UltraSpeed r-MicroSpeed Max Mop	43	
r-NanoTech Micro	10	UltraSpeed Mini Starter Kit	47	Floor Cleaning
r-Trio Max	44	UltraSpeed Pro Frame	43	
r-Tronic	40	UltraSpeed Pro Ready-to-Go Sets	42	Floor Cleaning
SafeGrip	27	UltraSpeed Pro Single Bucket	42	
SafeMop	47	UltraSpeed r-Trio Max	43	Floor Cleaning
Shopster	90	UltraSpin Mini Starter Kit	48	
Sieve	76	UltraSpin Mini Microfibre Mop	48	Brushware
Single & Double Bucket System	44	UltraSpin Mini Frame	48	
Small buckets	78	Universal	25	Brushware
Softy	12	Universal Aluminum Handle	52	
Sponge cloth "aqua"	15	Vileda Bathcleaner "Soft"	20	Brushware
SprayPro INOX	49	Vileda "Heavy Duty" (Black Abrasive)	20	
Steel SuperMop Handle	53	Vileda "Non-Scratch"	20	Brushware
Storage Boxes	76	Vileda "Strong" (Green Abrasive)	20	
Superior Broom soft/hard	62	Vlieser	53	Trolleys
Superior Deck Scrubber	62	VoleoPro	89	
Superior Dish Brush	63	Wall/Door	89	Trolleys
Superior Hand Brush	63	Waste collection CXL	80	
SuperMop AG	48	Waste/Laundry Collection	87	Waste Management
Superpad black	56	WiPro (antibacterial)	16	
Superpad blue	57	Wringer and Presses	86	Waste Management
Superpad brown	56			
Superpad green	56			Waste Management
Superpad grey	58			
Superpad red	57			Waste Management

## Vileda Professional – a part of the Freudenberg Group

Vileda Professional provides innovative cleaning solutions and systems for professional users in various application areas, such as General Building, Healthcare, HoReCa and Controlled Environment. With sales offices in all major European countries, in North America and Asia – and with a wide net of representatives – we are well located around the world. Vileda Professional belongs to the Freudenberg Group – a diversified family-run global company, headquartered in Germany.

  
**PROFESSIONAL**

  
**VERMOP**

### Vileda Professional

Vileda GmbH

Im Technologiepark 19, 69469 Weinheim

E-Mail: [vileda.professional.export@fhp-ww.com](mailto:vileda.professional.export@fhp-ww.com)

<https://export.vileda-professional.com>

a brand of  
 **FREUDENBERG**